

Federal Highway Administration University Course on Bicycle and Pedestrian Transportation

Publication No. FHWA-HRT-05-133
July 2006



U.S. Department of Transportation
Federal Highway Administration

Research, Development, and Technology
Turner-Fairbank Highway Research Center
6300 Georgetown Pike
McLean, VA 22101-2296



Pedestrian and Bicycle Safety

FOREWORD

The transportation, urban planning, and public health professions are placing an increased emphasis on walking and bicycling as part of the solution to problems such as traffic congestion, suburban sprawl, and childhood obesity. An interdisciplinary approach from educated professionals is needed to create healthy, sustainable, and livable communities. The Federal Highway Administration (FHWA) University Course on Bicycle and Pedestrian Transportation is one of several resources that can be used to prepare the next generation of professionals for the challenges ahead.

The University Course contains modular resource material that is intended for use in university courses on bicycle and pedestrian transportation. The *Student Workbook* (this document) contains 24 lessons that span a wide range of topics including an introduction to bicycling and walking issues, planning and designing for bicycle and pedestrian facilities, and supporting elements and programs. Scripted slideshows for all 24 lessons are available to facilitate course development and delivery. An overview lecture and scripted slideshow also is provided when a one- or two-lecture overview is needed for existing undergraduate or graduate courses.

Instructors are encouraged to use any or all of this material to form a curriculum that meets their needs. Most of the lessons are stand-alone in nature, with lessons of similar topics grouped into modules. A majority of the instructors using the first edition of these course materials have personalized the lessons for their courses by removing some lessons, adding supplemental material, reorganizing the lessons, and adding exercises and local activities that encourage student participation.

Michael F. Trentacoste
Director, Office of Safety
Research and Development

Notice

This document is disseminated under the sponsorship of the U.S. Department of Transportation in the interest of information exchange. The U.S. Government assumes no liability for the use of the information contained in this document. This report does not constitute a standard, specification, or regulation.

The U.S. Government does not endorse products or manufacturers. Trademarks or manufacturers' names appear in this report only because they are considered essential to the objective of the document.

Quality Assurance Statement

The Federal Highway Administration (FHWA) provides high-quality information to serve Government, industry, and the public in a manner that promotes public understanding. Standards and policies are used to ensure and maximize the quality, objectivity, utility, and integrity of its information. FHWA periodically reviews quality issues and adjusts its programs and processes to ensure continuous quality improvement.

1. Report No. FHWA-HRT-05-133	2. Government Accession No.	3. Recipient's Catalog No.	
4. Title and Subtitle FHWA UNIVERSITY COURSE ON BICYCLE AND PEDESTRIAN TRANSPORTATION: STUDENT WORKBOOK		5. Report Date July 2006	
		6. Performing Organization Code	
7. Author(s) Shawn Turner, Laura Sandt, Jennifer Toole, Robert Benz, and Robert Patten		8. Performing Organization Report No.	
9. Performing Organization Name and Address Texas Transportation Institute Toole Design Group, LLC The Texas A&M University System 535 Main Street, Suite 211 College Station, TX 77843-3135 Laurel, MD 20707		10. Work Unit No. (TRAIS)	
		11. Contract or Grant No. DTFH61-01-C-00049	
12. Sponsoring Agency Name and Address Office of Safety Research and Development Federal Highway Administration 6300 Georgetown Pike McLean, VA 22101-2296		13. Type of Report and Period Covered Final Report March 2003–July 2005	
		14. Sponsoring Agency Code	
15. Supplementary Notes: Research performed under subcontract to the University of Michigan Transportation Research Institute (UMTRI). Task Order Manager: Ann Do, HRDS-06 Contracting Officer's Technical Representative (COTR): Gabe Rousseau, HRDS-07			
16. Abstract This <i>Student Workbook</i> contains 24 lessons of resource material that is intended for use in university courses on bicycle and pedestrian transportation. The lessons span a wide range of topics including an introduction to bicycling and walking issues, planning and designing for bicycle and pedestrian facilities, and supporting elements and programs. This is the second edition of the <i>Student Workbook</i> ; the first edition was published as Report No. FHWA-RD-99-198. Lesson-based slideshows (scripted slideshows for all 24 lessons) and an overview lecture (a scripted slideshow for a one- or two-lecture overview in existing undergraduate or graduate transportation courses) are also available to assist in course development and delivery. The key learning outcomes in the course material are as follows: <ul style="list-style-type: none"> • Students should recognize the legitimacy of the bicycle and pedestrian modes in a balanced transportation system. • Students should understand how policy, planning, and engineering practices can be improved to create a more balanced transportation system. • Students should be familiar with basic policies, practices, tools, and design principles and know how to use them to create bicycle and pedestrian-friendly communities. 			
17. Key Words Bicycling, walking, cyclists, pedestrians, bicycle facilities, pedestrian areas, planning and design, traffic calming		18. Distribution Statement No restrictions. This document is available to the public through the National Technical Information Service, Springfield, VA 22161.	
19. Security Classif. (of this report) Unclassified	20. Security Classif. (of this page) Unclassified	21. No. of Pages 452	22. Price

SI* (MODERN METRIC) CONVERSION FACTORS

APPROXIMATE CONVERSIONS TO SI UNITS

Symbol	When You Know	Multiply By	To Find	Symbol
LENGTH				
in	inches	25.4	millimeters	mm
ft	feet	0.305	meters	m
yd	yards	0.914	meters	m
mi	miles	1.61	kilometers	km
AREA				
in ²	square inches	645.2	square millimeters	mm ²
ft ²	square feet	0.093	square meters	m ²
yd ²	square yard	0.836	square meters	m ²
ac	acres	0.405	hectares	ha
mi ²	square miles	2.59	square kilometers	km ²
VOLUME				
fl oz	fluid ounces	29.57	milliliters	mL
gal	gallons	3.785	liters	L
ft ³	cubic feet	0.028	cubic meters	m ³
yd ³	cubic yards	0.765	cubic meters	m ³
NOTE: volumes greater than 1000 L shall be shown in m ³				
MASS				
oz	ounces	28.35	grams	g
lb	pounds	0.454	kilograms	kg
T	short tons (2000 lb)	0.907	megagrams (or "metric ton")	Mg (or "t")
TEMPERATURE (exact degrees)				
°F	Fahrenheit	5 (F-32)/9 or (F-32)/1.8	Celsius	°C
ILLUMINATION				
fc	foot-candles	10.76	lux	lx
fl	foot-Lamberts	3.426	candela/m ²	cd/m ²
FORCE and PRESSURE or STRESS				
lbf	poundforce	4.45	newtons	N
lbf/in ²	poundforce per square inch	6.89	kilopascals	kPa

APPROXIMATE CONVERSIONS FROM SI UNITS

Symbol	When You Know	Multiply By	To Find	Symbol
LENGTH				
mm	millimeters	0.039	inches	in
m	meters	3.28	feet	ft
m	meters	1.09	yards	yd
km	kilometers	0.621	miles	mi
AREA				
mm ²	square millimeters	0.0016	square inches	in ²
m ²	square meters	10.764	square feet	ft ²
m ²	square meters	1.195	square yards	yd ²
ha	hectares	2.47	acres	ac
km ²	square kilometers	0.386	square miles	mi ²
VOLUME				
mL	milliliters	0.034	fluid ounces	fl oz
L	liters	0.264	gallons	gal
m ³	cubic meters	35.314	cubic feet	ft ³
m ³	cubic meters	1.307	cubic yards	yd ³
MASS				
g	grams	0.035	ounces	oz
kg	kilograms	2.202	pounds	lb
Mg (or "t")	megagrams (or "metric ton")	1.103	short tons (2000 lb)	T
TEMPERATURE (exact degrees)				
°C	Celsius	1.8C+32	Fahrenheit	°F
ILLUMINATION				
lx	lux	0.0929	foot-candles	fc
cd/m ²	candela/m ²	0.2919	foot-Lamberts	fl
FORCE and PRESSURE or STRESS				
N	newtons	0.225	poundforce	lbf
kPa	kilopascals	0.145	poundforce per square inch	lbf/in ²

*SI is the symbol for the International System of Units. Appropriate rounding should be made to comply with Section 4 of ASTM E380.
(Revised March 2003)

Table of Contents

	<u>Page</u>
LESSON 1: THE NEED FOR BICYCLE AND PEDESTRIAN MOBILITY	1
1.1 Introduction	1
1.2 How Cities Grow: A Historical Perspective.....	1
1.3 Modern Suburban Travel.....	3
1.4 Benefits of Bicycling and Walking	4
Transportation System Benefits	4
Environmental Benefits	4
Economic Benefits.....	4
Quality of Life Benefits.....	5
Health Benefits	6
1.5 Government Commitment and Support.....	7
Funding Sources for Bicycle and Pedestrian Projects	8
Federal Transit Program (FTP)	9
Highway Safety Programs	10
1.6 Public Support for Bicycling and Walking.....	10
1.7 Transportation and Planning Trends.....	10
1.8 Student Exercises.....	14
Exercise A	14
Exercise B.....	15
Exercise C.....	15
1.9 References and Additional Resources	15
LESSON 2: BICYCLING AND WALKING IN THE UNITED STATES TODAY.....	19
2.1 Introduction	19
2.2 Current Levels of Bicycling and Walking.....	20
2001 National Household Transportation Survey (NHTS)	20
Other National Surveys	22
2.3 Factors Influencing the Decision to Bicycle or Walk.....	23
Initial Considerations.....	23
Trip Barriers	24
Destination Barriers.....	25
2.4 Potential for Increasing Bicycling and Walking.....	25
Public Support for Bicycling and Walking.....	25
Other Considerations.....	26
2.5 Need for Action: Pedestrians and Bicyclists at Risk	27
2.6 Student Exercises.....	28
Exercise A	28
Exercise B.....	28
Exercise C.....	28
Exercise D	28
2.7 References and Additional Resources	28
LESSON 3: PEDESTRIAN AND BICYCLIST SAFETY.....	31
3.1 Introduction	31
3.2 What Is a Crash?.....	31
3.3 The Crash Avoidance Process	32
3.4 Number of Bicycle and Pedestrian Crashes.....	32

3.5	Summary of Bicycle and Pedestrian Crash Characteristics.....	34
	Bicycle-Motor Vehicle Crashes	34
	Factors Contributing to Bicycle-Motor Vehicle Crashes	35
	Pedestrian-Motor Vehicle Crashes	35
	Factors Contributing to Pedestrian-Motor Vehicle Crashes	36
3.6	Common Pedestrian and Bicycle Crash Types.....	36
	Pedestrian Crash Types	37
	Bicycle Crash Types.....	37
3.7	Pedestrian and Bicycle Crash Analysis Tool (PBCAT)	46
3.8	Bicycle and Pedestrian Countermeasures.....	46
3.9	Bicycle and Pedestrian Safety Goals	49
3.10	Geographic Information System (GIS) Crash Frequency Analysis.....	49
3.11	Benefit-Cost Analysis.....	49
3.12	Student Exercise	50
	Part 1.....	50
	Part 2.....	50
	Part 3.....	54
3.13	References and Additional Resources	55
LESSON 4: BICYCLE AND PEDESTRIAN PLANNING.....		57
4.1	Introduction	57
4.2	Federal Requirements for Planning	57
4.3	Statewide and Regional Pedestrian and Bicycle Plans	58
	Statewide Bicycle and/or Pedestrian Plans.....	58
	Regional Bicycle and/or Pedestrian Plans	59
4.4	Local Bicycle and Pedestrian Plans.....	59
	Setting Priorities	60
	Developing a Bicycle Network Plan	61
4.5	Forecasting Bicycle and Pedestrian Travel Demand.....	65
4.6	Using Models to Evaluate Roadway Conditions for Bicycling and Walking	66
	Bicycle LOS	67
	Application	69
4.7	Mapping.....	71
	Urban Bicycle Map.....	71
	Bicycle Guide	71
	Other Useful Tips	72
4.8	Student Exercise	72
4.9	References and Additional Resources	72
LESSON 5: LAND USE REGULATIONS TO ENCOURAGE NONMOTORIZED TRAVEL		75
5.1	Introduction	75
5.2	Pedestrian-Oriented Land Use.....	75
	Zoning and Subdivision Regulations.....	76
	Community Visioning	79
	Development Review Process	79
5.3	Commercial Development Design Guidance	80
5.4	Performance-Based Code as a Development (or Redevelopment) Tool	81
5.5	Guidance on Designing Residential Communities That Encourage Walking.....	82
5.6	Student Exercise	83
5.7	References and Additional Resources	84

LESSON 6: TRADITIONAL NEIGHBORHOOD DESIGN.....	85
6.1 Introduction	85
6.2 The New Urbanism Debate	85
6.3 “Putting Brakes on Suburban Sprawl”	86
6.4 Street Design for Traditional Neighborhoods.....	92
Basic Street Layout.....	92
Use of Alleys.....	93
Street Design Speed.....	93
Street Width.....	94
Curb Radii	95
Intersection Geometry	95
Street Trees and Landscaping.....	95
Street Lighting.....	96
Sidewalk Width and Location	96
Building Setbacks.....	97
Parking.....	97
6.5 Student Exercise	98
6.6 References and Additional Resources	99
LESSON 7: ADAPTING SUBURBAN COMMUNITIES FOR BICYCLE AND PEDESTRIAN TRAVEL	101
7.1 Introduction	101
7.2 History of Suburban Development	101
Abandoning the Street	104
7.3 Costs of Sprawl.....	105
7.4 Present Suburban Land Uses	105
7.5 Planning With the Car in Mind.....	106
7.6 Strategies for Retrofitting Suburban Arterial Roadways.....	106
7.7 Safe Routes to School Planning.....	107
7.8 Existing Retail/Office Developments	108
7.9 Student Exercise	110
7.10 References and Additional Resources	110
LESSON 8: PEDESTRIAN CHARACTERISTICS.....	113
8.1 Introduction	113
8.2 Characteristics of Different Age Groups	114
Young Pedestrians	114
Older Pedestrians.....	116
8.3 Other Pedestrian Types and Characteristics	117
Mobility-Impaired Pedestrians	118
8.4 Walking Speeds	118
Older Pedestrians.....	119
Pedestrians with Disabilities.....	120
8.5 Space Requirements	120
Spatial Bubbles.....	121
Pedestrians with Disabilities.....	122
8.6 Design Requirements.....	123
Sidewalks.....	123
Grades.....	125
Street Furniture.....	125

	Pedestrian Pushbuttons.....	126
	Curb Cuts and Wheelchair Ramps	127
8.7	Student Exercise	132
8.8	References and Additional Resources	133
LESSON 9: WALKWAYS, SIDEWALKS, AND PUBLIC SPACES		
9.1	Introduction	135
9.2	Sidewalk Placement.....	135
	Priority Construction of Sidewalks	136
9.3	Basic Sidewalk Elements.....	136
	Minimum Sidewalk Width	136
	Desirable Sidewalk Width.....	137
	Bridge Sidewalks.....	137
	Rural Sidewalks.....	138
	Border Areas and Buffers	138
	Grade	140
	Cross Slopes	140
	Pavement Surfaces.....	140
	Stairs	141
	Corners	141
	Corner Ramps.....	142
	Corner Storage Space	142
	Object Clearances and Placement of Street Furniture	143
	Continuity	145
9.4	Summary of Basic Sidewalk Elements.....	146
9.5	Ambience, Shade, and Other Sidewalk Enhancements	146
	Street Lighting.....	146
	Landscaping.....	147
	Trees	148
	Paver Stones	148
	Awnings.....	148
	Kiosks.....	149
9.6	Costs and Benefits of Sidewalks	149
9.7	Public Spaces.....	150
	Outdoor Cafes.....	150
	Alleys and Narrow Streets.....	150
	Play Areas and Public Art	151
	Pedestrian Streets, Transit Streets, and Pedestrian Malls.....	151
	Pedestrian Plazas	152
9.8	Student Exercise	154
	Part 1.....	154
	Part 2.....	154
9.9	References and Additional Resources	155
LESSON 10: PEDESTRIAN FACILITY SIGNING AND PAVEMENT MARKINGS.....		
10.1	Introduction	157
10.2	Background.....	157
10.3	Planning and Design Considerations.....	158
10.4	Regulatory Signs	159
10.5	Warning Signs	161
10.6	Directional Signs	163

10.7	Pavement Word and Symbol Markings.....	163
10.8	Crosswalk Markings.....	164
	Marked Versus Unmarked Crosswalks	166
10.9	Intelligent Transportation Systems (ITS) Technology	168
	In-Roadway Warning Lights	168
	Countdown Signal	169
	Animated Eyes Display	170
	Detection Devices.....	171
	Illuminated Pushbuttons	172
10.10	Student Exercise	173
10.11	References and Additional Resources	174
LESSON 11: PEDESTRIAN DESIGN AT INTERSECTIONS		177
11.1	Introduction	177
11.2	Intersection Design Principles	177
11.3	Crosswalks.....	179
	Typical Concerns.....	179
	Possible Solutions.....	179
	Implementation Strategies	181
	Resources and Scheduling.....	181
	Evaluation.....	181
	Planning and Design Considerations.....	181
11.4	Curb Ramps	182
	Typical Concerns.....	182
	Possible Solutions.....	182
	Implementation Strategies	182
	Resources and Scheduling.....	184
	Evaluation.....	184
	Planning and Design Considerations.....	184
11.5	Crossing and Detection Technology.....	185
	Typical Concerns.....	185
	Possible Solutions.....	185
11.6	Pedestrian Signal Heads and Half-Signals	188
	Typical Concerns.....	188
	Possible Solutions.....	189
	Implementation Strategies	189
	Resources and Scheduling.....	190
	Evaluation.....	190
	Planning and Design Considerations.....	190
11.7	Curb Extensions and Curb Radii	191
	Typical Concerns.....	191
	Possible Solutions.....	191
	Implementation Strategies	193
	Resources and Scheduling.....	193
	Evaluation.....	193
	Planning and Design Considerations.....	193
11.8	Signal Timing and Pushbuttons	194
	Typical Concerns.....	194
	Possible Solutions.....	195
	Implementation Strategies	195
	Resources and Scheduling.....	195

	Evaluation.....	195
	Planning and Design Considerations.....	196
11.9	Pedestrian Refuge Islands.....	198
	Recommended Practice	200
	Island Design Features	200
11.10	Roundabouts.....	201
	Typical Concerns.....	201
	Possible Solutions.....	205
	Planning and Design Considerations.....	205
11.11	Student Exercise	206
11.12	References and Additional Resources	207
LESSON 12: MIDBLOCK CROSSINGS		209
12.1	Introduction	209
12.2	Background.....	209
12.3	Medians and Refuge Islands—Powerful Safety Tools.....	210
12.4	Advantages of Medians	211
	Medians Allow More Frequent Gaps	211
	Medians Are Less Expensive To Build.....	212
	Medians Are Less Expensive To Maintain.....	212
12.5	Design Considerations for Medians	213
12.6	Midblock Crossings by Roadway Classification.....	213
	Local Roads.....	213
	Collector Roads.....	214
	Multilane Arterial Highways with Four Lanes.....	214
	Multilane Arterial Highways with Six or More Lanes.....	214
12.7	Midblock Crossing Design.....	215
	Connect Desire Lines	215
	Lighting	215
12.8	Staggered Midblock Crosswalks	216
12.9	Midblock Crossing and Detection Technology.....	217
12.10	Midblock Signals.....	217
12.11	Grade-Separated Crossings.....	218
12.12	Student Exercise	219
12.13	References and Additional Resources	219
LESSON 13: SELECTING BICYCLE FACILITY TYPES AND EVALUATING ROADWAYS.....		221
13.1	Introduction	221
13.2	Overview of Bicycle Facility Selection.....	221
13.3	AASHTO Guidance on Selecting Bicycle Facility Type	224
13.4	Overview of Evaluating Roads for Bicyclists	225
13.5	Bicycle Compatibility Index.....	225
13.6	Bicycle Level of Service.....	227
13.7	Student Exercise	229
13.8	References and Additional Resources	230
LESSON 14: SHARED ROADWAYS		231
14.1	Introduction	231
14.2	Shared Roadways	231
14.3	Wide Curb Lanes.....	232
14.4	Roadway Shoulders or Shoulder Bikeways.....	234

	Width Standards	235
	Pavement Design	235
	The Joint between the Shoulders and the Existing Roadway	236
	Gravel Driveways and Approaches	237
14.5	Designated Bicycle Routes	238
14.6	Bicycle Boulevards	239
	Advantages of Bicycle Boulevards	239
	Disadvantages of Bicycle Boulevards	240
	Elements of a Bicycle Boulevard	240
14.7	Other Design Considerations	242
	Rumble Strips	242
	Drainage Grates	244
	Railroad Crossings	245
	Sidewalk Ramps on Bridges	245
14.8	Practices to Avoid	247
	Sidewalk Bikeways	247
	Extruded Curbs	247
	Reflectors and Raised Pavement Markers	247
14.9	Student Exercise	247
14.10	References and Additional Resources	248
LESSON 15: BICYCLE LANES		249
15.1	Introduction	249
15.2	Width Standards and Cross-Section Design	249
15.3	Retrofitting Bicycle Lanes on Existing Streets	251
	Reduction of Travel Lane Widths	252
	Reduction of the Number of Travel Lanes	252
	Removal, Narrowing or Reconfiguration of Parking	254
	Other Design Options	257
	Additional Benefits from Retrofitting Bike Lanes	257
	Salem, OR, Case Study	257
15.4	Bicycle Lanes at Intersections and Interchanges	258
	Intersections with Right-Turn Lanes	258
	Intersections with Bus Stops	262
	Traffic Signal Actuation	262
	Expressway Interchanges	264
15.5	Bicycle Lane Pavement Markings	266
15.6	Bicycle Lane Signing	267
15.7	Other Design Considerations	269
	Colored Bike Lanes	269
	Contraflow Bike Lanes	270
	Diagonal Parking	271
15.8	Practices to Avoid	272
	Two-Way Bike Lanes	272
	Continuous Right-Turn Lanes	273
15.9	Student Exercise	274
	Exercise A	274
	Exercise B	274
15.10	References and Additional Resources	275

LESSON 16: BICYCLE FACILITY MAINTENANCE	277
16.1 Introduction	277
16.2 Problem Overview	277
16.3 Solution Overview	277
16.4 Objectives	278
16.5 Implementation Strategies	279
16.6 Subtasks	280
Subtask 1—Identify Key Implementers	280
Subtask 2—Review Existing Policies and Practices	280
Subtask 3—Review Results in the Field and Solicit Comments from Users	280
Subtask 4—Recommend Appropriate Changes in Policies and Practices	280
Subtask 5—Create an Ongoing Spot Improvement Program	280
Subtask 6—Evaluate Progress	281
16.7 Schedule and Resource Requirements	281
16.8 Typical Maintenance Concerns	282
Surface Problems	282
Encroaching Vegetation	282
Signing and Marking	283
16.9 Student Exercise	283
16.10 References and Additional Resources	284
LESSON 17: BICYCLE PARKING AND STORAGE	285
17.1 Introduction	285
17.2 Overview of the Problem	285
17.3 Overview of Bicycle Parking Strategies	286
17.4 Implementing Bicycle Parking Strategies	287
Step 1—Identify Key Implementers	287
Step 2—Structure the Program	288
Step 3—Identify Priority Locations that Need Bicycle Parking	288
Step 4—Choose Appropriate Bicycle Parking Devices	290
Step 5a—Tasks for Developing Public Bicycle Parking	292
Step 5b—Tasks for Developing Private Bicycle Parking	293
Step 5c—Tasks for Revising Zoning Regulations	293
Step 6—Implement the Program	294
Step 7—Evaluate Progress	294
17.5 Student Exercise	297
Exercise A	297
Exercise B	297
17.6 References and Additional Resources	297
LESSON 18: BICYCLE AND PEDESTRIAN CONNECTIONS TO TRANSIT	299
18.1 Introduction	299
18.2 Interagency Cooperation	300
18.3 Why Link Bicyclists With Transit Services?	300
18.4 Bike-on-Bus Programs	300
18.5 Bike-on-Rail Programs	303
Time Restrictions	304
Rail Car Design Constraints	304
18.6 Example Transit Access Programs	304
18.7 Bicycle Parking Facilities at Transit Stations	305
18.8 Bikestation	306

18.9	What Are the Key Elements of Successful Programs?	306
	Demonstration Projects	306
	Advisory Committees	306
	Marketing and Promotion	306
18.10	Student Exercise	307
	Exercise A	307
	Exercise B	307
18.11	References and Additional Resources	307
LESSON 19: GREENWAYS AND SHARED-USE PATHS		309
19.1	Introduction	309
19.2	Shared-Use Path Definition	309
19.3	Shared-Use Path Users	310
19.4	User Conflict	311
19.5	Shared-Use Path Types and Settings	311
19.6	Planning	313
19.7	Rail-Trails, Rails-with-Trails, and Towpaths	314
19.8	Greenway Paths	314
19.9	Paths Adjacent to Roadways	315
19.10	Path Design	315
	Accessible Path Design	316
	Trail Width and Striping	316
	Trail/Roadway Intersection Design	317
	Other Design Issues	319
19.11	Student Exercise	322
19.12	References and Additional Resources	322
LESSON 20: TRAFFIC CALMING		325
20.1	Introduction	325
20.2	Traffic-Calming Objectives	326
20.3	Traffic-Calming Issues	326
20.4	Traffic-Calming Devices	328
	Bumps, Humps, and Other Raised Pavement Areas	329
	Reducing Street Area	333
	Street Closures	340
	Traffic Diversion	342
	Surface Texture and Visual Devices	349
20.5	Traffic-Calming Impacts	351
	Traffic Speeds	351
	Traffic Volumes	351
	Collisions	352
	Other Factors	353
20.6	Putting the Design Techniques to Work: Selected Examples of Traffic Calming	353
	The Woonerf	353
	Entry Treatment Across Intersections	356
	Bicycle Boulevards	356
	Channelization Changes	357
20.7	Student Exercise	358
20.8	References and Additional Resources	358

LESSON 21: BICYCLE AND PEDESTRIAN ACCOMMODATION IN WORK ZONES.....	361
21.1 Introduction	361
21.2 Possible Solutions.....	362
Protective Barriers	362
Covered Walkways.....	363
Sidewalk Closures	363
Signage	365
Diversions and Detours	365
21.3 Implementation Strategies	366
Link to Construction Permits.....	366
Train In-House Work Crews	366
21.4 Planning and Design Considerations	368
Rural Highway Construction.....	368
Urban Roadway Construction	368
Pedestrian Issues: Seattle Example	369
21.5 Student Exercise	370
21.6 References and Additional Resources	371
 LESSON 22: TORT LIABILITY AND RISK MANAGEMENT	 373
22.1 Introduction	373
22.2 Tort Liability for Bicycle and Pedestrian Facilities.....	373
22.3 Trends and Example Cases.....	374
Planning, Engineering, and Public Perception	375
Governments Can Be Sued for What They Do	375
Governments Can Be Sued for What They Do Not Do	376
The Impact of These Trends.....	378
22.4 Basic Definitions	378
Tort	378
Negligence.....	379
Ordinary Care	381
Sovereign Immunity	381
22.5 Cases That Lead to Quick Settlements against a Government	382
22.6 Risk Assessment and Management	384
The General Process	384
Scottsdale, Arizona Case Study.....	385
Is Ignorance Really Bliss?	386
Spot Maintenance and Improvement Programs.....	387
22.7 Student Exercise	388
22.8 References and Additional Resources	389
 LESSON 23: INTERNATIONAL APPROACHES TO BICYCLE AND PEDESTRIAN FACILITY DESIGN.....	 391
23.1 Introduction	391
23.2 Overview of Trends and Issues	391
23.3 Pedestrian Facilities and Programs.....	393
Zebra Crossings.....	393
Pelican Crossings	394
Toucan Crossings	396
Puffin Crossings	396
Pedestrian Messages on Pavement	397
Pedestrian Displays for Traffic Signals.....	397

	Animated Eyes on Pedestrian Signals	398
	Pedestrian Zones.....	399
23.4	Bicycle Facilities and Programs	400
	The Netherlands	400
	Germany	403
	The United Kingdom.....	406
23.5	Student Exercise	408
23.6	References and Additional Resources	408
LESSON 24: A COMPREHENSIVE APPROACH: ENGINEERING, EDUCATION, ENCOURAGEMENT, ENFORCEMENT, AND EVALUATION.....		409
24.1	Introduction	409
24.2	The Importance of Comprehensive Programs	409
	Example One	410
	Example Two	411
24.3	Integrating Elements in a Comprehensive Approach	411
	Determining the Scope of a Comprehensive Program	412
	Steps in the Process	413
24.4	Elements of an Effective Education Program.....	413
	Provide Instruction in Lawful, Responsible Behavior Among Bicyclists, Pedestrians, and Motorists.....	413
	Deliver Important Safety Messages Through Various Print and Electronic Media	415
24.5	Elements of an Effective Enforcement Program	416
	Improve Existing Traffic Laws, as Well as Their Enforcement.....	416
	Reduce the Incidence of Serious Crimes Against Nonmotorized Travelers	417
	Use Nonmotorized Modes to Help Accomplish Other Unrelated Departmental Goals.....	418
24.6	Elements of an Effective Encouragement Program.....	418
	Reduce or Eliminate Disincentives for Bicycling and Walking and Incentives for Driving Single-Occupant Motor Vehicles	419
	Provide Ways for Nonparticipants to Receive a Casual Introduction to Bicycling and Walking	419
	Use Electronic and Print Media to Spread Information on the Benefits of Nonmotorized Travel.....	420
24.7	Evaluation of Bicycle and Pedestrian Programs.....	421
24.8	Student Exercise	421
	Exercise A	421
	Exercise B.....	421
	Exercise C.....	421
24.9	References and Additional Resources	421

List of Figures

	<u>Page</u>
Figure 1-1. Photo. Wide suburban streets like this one were not built to accommodate or encourage walking.....	2
Figure 1-2. Photo. Many modern developments are designed to cater to automobile travel.	3
Figure 1-3. Photo. There are many economic benefits to building bicycle and pedestrian facilities like this shared-use path.....	5
Figure 1-4. Photo. Walking can have a tremendous health benefit.....	6
Figure 1-5. Photo. Many State DOTs are adopting “complete streets” policies.	11
Figure 1-6. Photo. Safe Routes to School programs are being implemented throughout the U.S.	12
Figure 1-7. Photo. There are growing trends in public involvement in local transportation planning processes.....	14
Figure 2-1. Photo. Sidewalks must be designed to serve people of all abilities.....	19
Figure 2-2. Chart. Transportation mode data from the 2001 NHTS.....	20
Figure 2-3. Chart. Percentage bicycling in past 30 days by gender, age, race/ethnicity.....	22
Figure 2-4. Photo. Street crossings can be a significant barrier to walking.	24
Figure 3-1. Photo. Bicyclist scanning for potential hazards.....	32
Figure 3-2. Graph. Trends in pedestrian and bicyclist fatalities.	33
Figure 3-3. Graph. Trends in pedestrian and bicyclist injuries.	33
Figure 3-4. Illustration. Vehicle turn/merge.....	38
Figure 3-5. Illustration. Intersection dash.	38
Figure 3-6. Illustration. Other intersection.....	39
Figure 3-7. Illustration. Midblock dart/dash.	39
Figure 3-8. Illustration. Other midblock.	40
Figure 3-9. Illustration. Not in roadway/waiting to cross.	40
Figure 3-10. Illustration. Walking along roadway.	41
Figure 3-11. Illustration. Backing vehicle.	41
Figure 3-12. Illustration. Ride out at stop sign.	42
Figure 3-13. Illustration. Drive out at stop sign.	42
Figure 3-14. Illustration. Other ride out at intersection.....	43
Figure 3-15. Illustration. Drive out at midblock.	43
Figure 3-16. Illustration. Motorist left turn, facing bicyclist.....	44
Figure 3-17. Illustration. Ride out at residential driveway.....	44
Figure 3-18. Illustration. Bicyclist left turn in front of traffic.....	45
Figure 3-19. Illustration. Motorist right turn.....	45

Figure 3-20.	Photo. A crosswalk can increase the visibility of a pedestrian path.....	46
Figure 3-21.	Illustration. Bicycle crash locations.....	51
Figure 3-22.	Illustration. Pedestrian crash locations.	52
Figure 3-23.	Illustration. Site location map.....	52
Figure 4-1.	Photo. Group B (basic) bicyclists value designated bike facilities such as bike lanes.	62
Figure 4-2.	Photo. Several factors will determine the final design treatment used; two of the foremost are cost and controversy.	64
Figure 4-3.	Photo. Streets and roadways can be analyzed to determine the relative level of service they provide to bicyclists and pedestrians.	67
Figure 4-4.	Equation. Bicycle LOS.....	68
Figure 4-5.	Equation. Bicycle LOS sensitivity analysis.....	70
Figure 4-6.	Illustration. A bicycle route map provides bicyclists with information about street characteristics by using different color codes.....	71
Figure 5-1.	Photo. Low-density, single-use zoning creates trip distances that are too great to make walking a viable transportation option.....	76
Figure 5-2.	Illustration. Cul-de-sacs can restrict pedestrian and bicycle access.	77
Figure 5-3.	Illustration. Loops are preferred to cul-de-sacs.	77
Figure 5-4.	Illustration. Typical alley: ordinances should be modified to allow for rear-lot access.	78
Figure 5-5.	Illustration. Provide pedestrian connections between parcels.	81
Figure 6-1.	Illustration. New urbanism allows travel from one destination to another without using collector roads.....	87
Figure 6-2.	Photos. Mashpee Commons before and after retrofitting.	89
Figure 6-3.	Photo. Typical suburban neighborhoods offer few route choices for trips.....	93
Figure 6-4.	Photo. Neotraditional neighborhoods have narrower, tree-lined streets.....	96
Figure 6-5.	Photo. Typically, suburban parking lots in retail developments are vast—and rarely full.	98
Figure 7-1.	Photo. Inadequate maintenance of sidewalks makes a short walk difficult to maneuver.	103
Figure 7-2.	Photo. Parked cars and a lack of sidewalks along the road’s edge create unsafe conditions for bicyclists and pedestrians.....	103
Figure 7-3.	Photo. Sidewalks with a landscape strip should be installed to minimize exposure to vehicular traffic.	104
Figure 7-4.	Unless required by local ordinance, many developments focus on vehicle access without regard to pedestrian access.	106
Figure 7-5.	Photo. Building entrances and storefronts should be oriented to face the street.	109
Figure 7-6.	Photo. Medians and crosswalks should be placed at destination locations such as this shopping center.....	110
Figure 8-1.	Photo. People with children often walk at slower speeds.....	119

Figure 8-2.	Photo. Older pedestrians often have difficulty negotiating curbs.....	120
Figure 8-3.	Illustration. Recommended pedestrian body ellipse dimensions for standing areas.	121
Figure 8-4.	Illustration. Spatial dimensions for pedestrians.....	121
Figure 8-5.	Illustration. Forward clear space needed by pedestrians.	122
Figure 8-6.	Illustration. Spatial dimensions for people who use mobility devices.	122
Figure 8-7.	Illustration. Minimum passage width for one wheelchair and one ambulatory person.	123
Figure 8-8.	Illustration. Minimum passage width for two wheelchairs.	124
Figure 8-9.	Photo. Driveway slopes should not encroach into the sidewalk.....	125
Figure 8-10.	Illustration. High and low forward reach limits.	127
Figure 8-11.	Illustration. High and low side reach limits.....	127
Figure 8-12.	Illustration. Curb ramp with sidewalk next to curb.	128
Figure 8-13.	Illustration. Measurement of curb ramp slopes and counter slope.	128
Figure 8-14.	Illustration. Sides of curb ramps.....	129
Figure 8-15.	Photo. Perpendicular curb ramp.	129
Figure 8-16.	Photo. Parallel curb ramp.	130
Figure 8-17.	Illustration. Curb ramps at marked crossings.....	131
Figure 8-18.	Photo. A pavement grinding project left an exaggerated lip at this curb cut.....	132
Figure 9-1.	Photo. An example of a pedestrian-friendly streetscape.	135
Figure 9-2.	Photo. Bicyclists are often forced to use bridge sidewalks when they are not accommodated in the roadway.	138
Figure 9-3.	Illustration. The width of a natural buffer provides the essential space needed for situations such as protecting pedestrians from out-of-control vehicles.	139
Figure 9-4.	Photo. Parked cars can also serve as a buffer between the sidewalk and the street.	140
Figure 9-5.	Photo. This corner features public telephones and a sitting area that does not encroach on the walkway.	142
Figure 9-6.	Illustration. Example of clearances required to maintain effective walkway width.....	144
Figure 9-7.	Photo. Example of pedestrian-oriented street lighting.	147
Figure 9-8.	Photo. Street trees provide a desirable pedestrian environment.....	148
Figure 9-9.	Photo. Including amenities such as kiosks create pedestrian-friendly spaces.	149
Figure 9-10.	Photo. An outdoor cafe can add color and life to a street environment.....	150
Figure 9-11.	Photo. Alleys can be made attractive and can serve as access points to shops.	151
Figure 9-12.	Photo. Some European streets have been redeveloped as pedestrian malls.	152
Figure 9-13.	Photo. Small protected spaces provide separation from noise and traffic.	153
Figure 10-1.	Photo. The sign and crosswalk markings at this midblock crossing alert drivers to pedestrians going to school.	158
Figure 10-2.	Photo. Pedestrian crossing signs.....	160

Figure 10-3.	Photo. Pedestrians are restricted from continuing straight and are encouraged to cross left to avoid a traffic merge lane.	160
Figure 10-4.	Photo. Variation of R10-3b regulatory crossing sign.	161
Figure 10-5.	Photo. This pedestrian crossing sign is fluorescent yellow green (FYG), allowing it to be more visible.	162
Figure 10-6.	Photo. Flashing lights, school crossing signs, and a low speed limit gives motorists plenty of warning of the crossing area ahead.....	163
Figure 10-7.	Photo. “Look Right” or “Look Left” is painted on the street next to the curb in the United Kingdom.	164
Figure 10-8.	Illustration. An intersection with examples of crosswalk markings.	166
Figure 10-9.	Illustration. Common crosswalk marking patterns.	166
Figure 10-10.	Illustration. Example of in-roadway warning lights.	168
Figure 10-11.	Photo. Working example of in-roadway warning lights with pedestrian pushbutton in Austin, Texas.	169
Figure 10-12.	Photo. Example of countdown pedestrian signal in Lauderdale-By-The-Sea, FL.	170
Figure 10-13.	Example of animated eyes display.	170
Figure 10-14.	Example of a microwave detector system.	171
Figure 10-15.	Illustration. Example of an infrared detector system.	172
Figure 10-16.	Photo. Illuminated pushbuttons.	172
Figure 10-17.	Illustration. Example signing and marking plan for SR 8 by Fletcher Parkway Construction Plans, La Mesa, CA.	173
Figure 11-1.	Photo. Reduced visibility of pedestrians behind parked cars can create conflict.	178
Figure 11-2.	Photo. Use of colored crosswalks and median refuges makes this intersection more pedestrian-friendly.....	180
Figure 11-3.	Photo. Ramp request form used by the City of Seattle, WA, Engineering Department.	184
Figure 11-4.	Photo. Flag treatment used in Kirkland, WA.	186
Figure 11-5.	Photo. Fluorescent yellow-green sign treatment in Austin, TX.	186
Figure 11-6.	Photo. Flashing beacon treatment in Austin, TX.....	187
Figure 11-7.	Photo. Detectable warnings treatment in Roseville, CA.	187
Figure 11-8.	Photo. Staggered pedestrian crossings (Z-crossings) treatment in San Luis Obispo, CA.	188
Figure 11-9.	Photo. Half-signal in Portland, OR.....	189
Figure 11-10.	Photos. Curb extensions reduce crossing distances for pedestrians and provide additional corner storage space.	192
Figure 11-11.	Illustration. Curb extensions improve the visibility of pedestrians by motorists and vice versa.	192
Figure 11-12.	Photo. Example of obscure pedestrian pushbuttons; pushbuttons should be conveniently placed and clear from obstacles.	194

Figure 11-13. Illustration. Pedestrian crossing signals should be clear and understandable by all users.	196
Figure 11-14. Photo. Example of pedestrian pushbutton location.	197
Figure 11-15. Photo. Streets with raised medians usually have lower pedestrian crash rates.....	198
Figure 11-16. Photo. Refuge islands provide pedestrians with a resting place when crossing roads or intersections.	200
Figure 11-17. Illustration. Intersections have 16 vehicle/pedestrian conflict points.....	202
Figure 11-18. Illustration. Roundabouts have eight vehicle/pedestrian conflict points.	203
Figure 11-19. Illustration. Example traffic signal plan, Superior Parkway construction plans, Lawrenceville, GA.	206
Figure 12-1. Photo. Midblock crossings are easily located on low-volume, low-speed roadways such as short collectors through neighborhoods.....	210
Figure 12-2. Photo. Refuge islands and visible crosswalks are essential on major arterials with higher traffic speeds.....	211
Figure 12-3. Photo. A midblock crossing without median refuge requires the pedestrian to look for gaps in both directions at once.....	212
Figure 12-4. Photo. A midblock crossing with a median refuge allows the pedestrian to look for gaps in only one direction at a time.....	212
Figure 12-5. Photo. Landscaping a median can block midblock access and divert pedestrians to adjacent intersections.....	213
Figure 12-6. Illustration. Midblock crossing curb extensions provide better visibility for motorists and pedestrians.....	215
Figure 12-7. Illustration. Diagram of a staggered crossing configuration.	216
Figure 12-8. Photo. Staggered crosswalk with fencing.....	217
Figure 12-9. Photo. An underpass continues this shared-use bicycle path beneath a four-lane highway with high traffic volume.	218
Figure 13-1. Photo. Bicyclist on a shared roadway.....	222
Figure 13-2. Photo. Bicyclists in a wide curb lane.....	222
Figure 13-3. Photo. Bicyclist in a bike lane.	222
Figure 13-4. Photo. Bicyclists and pedestrians on a separated (shared-use) path.	222
Figure 13-5. Bar chart. A composite chart of numerous approaches to bicycle facility selection.	223
Figure 13-6. Equation. Bicycle LOS.....	227
Figure 13-7. Equation. Bicycle level of service sensitivity analysis.....	229
Figure 14-1. Illustration. Shared roadways include most existing roads and streets.....	232
Figure 14-2. Illustration. Example of a wide curb lane.....	233
Figure 14-3. Photo. Motorists overtaking bicyclists in a wide curb lane.	233
Figure 14-4. Illustrations. Various pavement markings for shared roadways and wide curb lanes.....	234
Figure 14-5. Illustration. Typical application of shared roadway pavement markings.....	234

Figure 14-6. Illustration. Example of a paved shoulder or shoulder bikeway.	235
Figure 14-7. Illustration. Example of a saw-cut pavement joint.	236
Figure 14-8. Illustration. Example of a feathered pavement joint.	236
Figure 14-9. Illustration. Example of the use of grindings as pavement base.	237
Figure 14-10. Illustration. A paved driveway apron reduces gravel on roadway shoulders.	237
Figure 14-11. Illustration. Typical signed shared route signing.	238
Figure 14-12. Illustration. Typical elements of a bicycle boulevard.	241
Figure 14-13. Illustration. Rumble strip guidance provided by ODOT.	243
Figure 14-14. Illustration. Examples of bicycle-safe drainage grates.	244
Figure 14-15. Illustration. Example of curb drainage inlet.	245
Figure 14-16. Illustration. Bike lane or shoulder crossing railroad tracks.	246
Figure 14-17. Illustration. Curb ramp provides access to sidewalk.	246
Figure 15-1. Illustrations. Typical bike lane cross sections.	250
Figure 15-2. Illustration. Retrofitting bike lanes by reducing travel lane widths.	252
Figure 15-3. Illustration. Reducing the number of travel lanes on a one-way street.	253
Figure 15-4. Illustration. Road diet: retrofitting bike lanes by reducing the number of travel lanes.	254
Figure 15-5. Illustration. Narrowing parking on a one-way street.	255
Figure 15-6. Illustration. Parking removed on one side of a two-way street.	255
Figure 15-7. Illustration. Changing from diagonal to parallel parking on a two-way street.	256
Figure 15-8. Illustration. Providing parking when there are no reasonable alternatives.	256
Figure 15-9. Illustration. Restriping for a wide curb lane.	257
Figure 15-10. Illustration. Typical pavement markings for bike lane on two-way street.	259
Figure 15-11. Illustrations. Possible configurations for bike lane and right-turn lane.	260
Figure 15-12. Illustrations. Design alternatives for a through bike lane with dual right-turn lanes.	261
Figure 15-13. Illustration. Right-turn lane shared by bicyclists and motorists.	262
Figure 15-14. Illustrations. Different loop detector configurations for traffic signals.	263
Figure 15-15. Illustration. Example of bicycle detector pavement marking.	263
Figure 15-16. Illustration. Bike lane configuration at entrance ramp (urban design—not for limited access freeways).	265
Figure 15-17. Illustration. Bike lane configuration at exit ramp (urban design—not for limited access freeways).	266
Figure 15-18. Illustrations. Examples of optional word and symbol pavement markings for bike lanes.	267
Figure 15-19. Illustrations. Regulatory signs for bicycle facilities.	268
Figure 15-20. Photo. Example of blue bike lane in Portland, OR.	269

Figure 15-21. Photo. Contraflow bike lane with bicycle-specific signal in Madison, WI.	271
Figure 15-22. Illustration. Use of wide stripe to separate bike lane from diagonal parking.	272
Figure 15-23. Illustration. A wrong-way bicyclist in a two-way bike lane is not in a driver’s field of vision.	273
Figure 15-24. Illustration. Reconfiguration of a continuous right-turn lane to be bicycle-friendly.	274
Figure 16-1. Photo. Shared-use paths and bicycle lanes may require additional maintenance.	278
Figure 16-2. Photo. Roadways with paved shoulders should reduce on-road debris.	279
Figure 16-3. Photo. Example of spot improvement postcard used to identify roadway maintenance issues.	281
Figure 16-4. Photo. Example of newly striped bicycle lane with accumulation of debris next to curb.	283
Figure 17-1. Photo. Effective bicycle parking improves security and reduces theft.	286
Figure 17-2. Illustrations and photo. Examples of common bicycle parking devices.	287
Figure 17-3. Illustrations. Recommended types of bicycle racks.	291
Figure 17-4. Illustrations. Bicycle rack types that are not APBP-recommended.	291
Figure 17-5. Illustration. APBP-recommended design dimensions for bicycle rack areas.	292
Figure 17-6. Photo. Excerpts from off-street parking ordinance in Madison, WI.	295
Figure 17-7. Illustration. Philadelphia’s standard for bike rack placement in business districts.	296
Figure 18-1. Photo. The preferred style of bike rack mounts to the front of the bus.	301
Figure 18-2. Photo. Some transit agencies allow bicyclists to carry their bikes onto buses.	302
Figure 18-3. Photos. Bicycle stencils on doors of Danish State railways indicate those cars where bikes may be brought on the train.	303
Figure 18-4. Photo. Lack of adequate bike parking is a common problem at urban subways.	305
Figure 19-1. Photo. To minimize user conflicts, adequate trail width is critical on paths having high volumes and diverse user mixes (Santa Barbara, CA).	310
Figure 19-2. Photo. Shared-use paths can be adjacent to railroad lines (Libba Cotton Trail, Carrboro, NC).	312
Figure 19-3. Photo. Shared-use paths can be integrated into urban waterfronts and parks, providing direct access to central business districts (East Bay Bicycle Path, Providence, RI).	313
Figure 19-4. Illustration. Typical cross section for multiuse trails.	317
Figure 19-5. Photo. Signs, bollards, and trail and crosswalk markings alert both motorists and bicyclists to this midblock trail crossing.	318
Figure 19-6. Photo. Stairway with bicycle rolling troughs (Capital Crescent Trail, Bethesda, MD).	320
Figure 19-7. Photo. Trailheads with parking and wayfinding signs assist shared-use path users (Rock Creek Trail, Montgomery County, MD).	321

Figure 19-8. Photo. Bridges and floating sections allow paths to cross water and maintain continuity (Eastside Esplanade, Portland, OR).....	322
Figure 20-1. Illustration. Examples of traffic-calming elements.	325
Figure 20-2. Photos. Traffic-calming devices are used to break up long, uninterrupted street vistas that encourage speeding.	326
Figure 20-3. Illustration. Traffic calming may not be necessary if the original problem is corrected.....	327
Figure 20-4. Photo. Emergency vehicle access should always be considered when incorporating traffic-calming measures.....	328
Figure 20-5. Photo. Speed humps can be combined with curb extensions and a winding street alignment.	329
Figure 20-6. Photo. Where possible, cyclists should be provided with cycle slips that enable them to bypass speed humps.	330
Figure 20-7. Photo. Raised crosswalks can slow traffic and give pedestrians a level surface at the crossing.....	330
Figure 20-8. Illustration. Examples of one-lane and two-lane slow points.....	334
Figure 20-9. Photo. This median refuge island provides railing and a staggered crossing area to direct pedestrian views toward oncoming traffic.....	336
Figure 20-10. Photo. A reduced radius allows for a slower, safer turn.....	338
Figure 20-11. Illustration. When turning radii are reduced, the width of an intersection is reduced as well.....	338
Figure 20-12. Photo. This traffic-calming measure uses a landscaped median to narrow the travel lanes.	339
Figure 20-13. Photo. The design of street closures should provide specific parking areas to discourage obstruction of bicycle and pedestrian traffic.....	341
Figure 20-14. Photo. Diagonal road closures/diverters limit vehicular access but allow emergency vehicles to enter through removable bollards.	342
Figure 20-15. Photo. Traffic circles can be designed to accommodate large vehicles and emergency access without undue restrictions.....	344
Figure 20-16. Photo. The splitter islands should be raised and landscaped to prevent left-turning vehicles from taking a shortcut across the island.	346
Figure 20-17. Photo. These pavement markings at a median refuge delineate the crossing for motorists and provide visible cues to sighted pedestrians as to the location of the roadway edge.....	349
Figure 20-18. Photo. Pavement treatments can be applied to the entire traffic-calmed area or limited to specific street uses.	350
Figure 20-19. Illustration. Model of a woonerf.....	354
Figure 20-20. Photo. The distinctions between sidewalks and roadways are blurred in woonerfs.....	356
Figure 20-21. Illustration. The conversion of a four-lane roadway—the elimination of one travel lane in each direction creates space for bicyclists.	357

Figure 21-1.	Utility work in bike lanes can often be accomplished without blocking the entire lane.	361
Figure 21-2.	Illustration. Example method to create passageways for pedestrians during construction.	364
Figure 21-3.	Illustration. Sidewalk closure and pedestrian detour example.	367
Figure 21-4.	Illustration. Construction sign placement.	369
Figure 21-5.	Illustration. Pedestrian control.	370
Figure 21-6.	Illustration. Pedestrian control.	370
Figure 22-1.	Photo. Courts have become less sympathetic to agencies that do not consider the needs of pedestrians and bicyclists.	374
Figure 22-2.	Photo. Bridges are a recurring theme in many tort liability claims.	377
Figure 22-3.	Photo. The needs of all users, young and old, should be considered in transportation planning and design.	378
Figure 22-4.	Photo. Example of a sidewalk ending at a bridge abutment with no warning or alternative path.	383
Figure 22-5.	Photo. An assessment of potential liability is the first step toward a proactive position.	385
Figure 22-6.	Photo. Use of signing to warn motorists and pedestrians of the potential hazard posed by vehicle mirrors on narrow bridge sidewalks.	387
Figure 22-7.	Photo. Example of spot improvement postcard used to identify roadway hazards.	388
Figure 23-1.	Bar chart. Walking and bicycling shares of urban travel in North America and Europe, 1995.	392
Figure 23-2.	Photo. Zebra crossing in London, U.K., with zigzag approach markings and Belisha beacons.	394
Figure 23-3.	Photo. Pedestrian pushbutton for pelican signals in the United Kingdom.	395
Figure 23-4.	Photo. Pedestrian signal with red standing man (shown) and green walking man.	395
Figure 23-5.	Photo. Toucan crossing in the United Kingdom provides separate pedestrian and bicyclist signal indications where trail crosses the road.	396
Figure 23-6.	Photo. Pedestrian messages on pavement in London, U.K.	397
Figure 23-7.	Photo. Animated eyes display used in conjunction with pedestrian signal.	399
Figure 23-8.	Photo. Pedestrian mall in Munster, Germany.	400
Figure 23-9.	Photo. Bicycle path in The Netherlands parallels the high-speed roadway.	401
Figure 23-10.	Typical bicycle lanes in The Netherlands have red pavement color and are wide enough for two bicyclists.	401
Figure 23-11.	Photo. Bicycle lane markings carried through an intersection in The Netherlands.	402
Figure 23-12.	Photo. Bicycle signal used in Amsterdam, The Netherlands.	403
Figure 23-13.	Photo. Sidewalk-based bicycle path used in Germany.	404
Figure 23-14.	Photo. Shared bus and bicycle lane in Germany.	404

Figure 23-15. Photo. Example of bicycle shelters located at a transit station in Germany.....	405
Figure 23-16. Photo. Narrow contraflow bicycle lane in Cambridge, U.K.....	406
Figure 23-17. Photo. Bicycle trail on an abandoned railroad right-of-way south of York, U.K.....	407
Figure 23-18. Photo. The entrance to this bicycle trail is designed to restrict entry to motor vehicles.	407
Figure 24-1. Photo. Comprehensive bicycle and pedestrian programs include more than bike lanes and sidewalks.....	410
Figure 24-2. Photo. Comprehensive bicycle and pedestrian programs bring together a variety of stakeholders.....	411
Figure 24-3. Photo. Safety education programs are essential for young children.....	414
Figure 24-4. Photo. Target safety messages to key audiences through various media.	415
Figure 24-5. Photo. The NHTSA <i>Resource Guide</i> can be used to improve existing traffic laws.	416
Figure 24-6. Photo. Police bicycle patrols are effective at outreach and crime prevention.	418
Figure 24-7. Photos. Vehicle license plates that promote sharing the road with bicyclists.	420

List of Tables

	<u>Page</u>
Table 2-1. Regional variations in modal shares for transit, walking, and bicycling.....	21
Table 3-1. Pedestrian crash types.....	37
Table 3-2. Bicycle crash types.....	37
Table 3-3. Crash types and associated countermeasures.....	47
Table 3-4. Tabulation of pedestrian crash data.....	53
Table 3-5. Tabulation of bicycle crash data.....	53
Table 3-6. Usage data collected at major park entrances.....	54
Table 3-7. Summary of major roadways.....	54
Table 4-1. Bicycle level of service categories.....	69
Table 5-1. Site plan checklist.....	79
Table 5-2. Levels of illumination for sidewalks.....	80
Table 6-1. Comparison of new urbanism versus standard street design practices.....	90
Table 8-1. Walking characteristics and abilities of different pedestrian age groups.....	115
Table 8-2. Characteristics of other pedestrian groups.....	117
Table 8-3. Design needs of mobility-impaired pedestrians.....	118
Table 8-4. Mean walking speeds for disabled pedestrians and users of various assistive devices.....	120
Table 9-1. Corner storage space by pedestrian volumes.....	143
Table 9-2. Preemption of walkway width.....	145
Table 9-3. Minimum and desirable design features.....	146
Table 10-1. Design requirements for crosswalk pavement markings.....	165
Table 10-2. Recommendations for installing marked crosswalks and other needed pedestrian improvements at uncontrolled locations.....	167
Table 11-1. Intersection issues for safe pedestrian crossings.....	178
Table 11-2. Roundabout trade-off issues for pedestrians.....	202
Table 13-1. Bicycle compatibility index model.....	226
Table 13-2. Bicycle level of service categories.....	228
Table 20-1. Description of bumps, humps, and other raised areas.....	331
Table 20-2. Bellevue, WA, speed hump findings.....	332
Table 20-3. Advantages and disadvantages of slow points.....	335
Table 20-4. Advantages and disadvantages of corner radius and narrowed lane treatments.....	339
Table 20-5. Advantages and disadvantages of diverters.....	343
Table 20-6. Comparison of roundabouts with traffic circles.....	344

Table 20-7. Advantages and disadvantages of roundabouts.	345
Table 20-8. Comparative crash rates for signalized intersections and roundabouts.	346
Table 20-9. Speed impacts downstream of traffic-calming measures.	351
Table 20-10. Volume impacts of traffic-calming measures.	352

Course Overview

For Students:

What is in this *Student Workbook*?

This *Student Workbook* contains resource material that is intended for use in university courses on bicycle and pedestrian transportation. The *Workbook* consists of 24 lessons that can serve as background reading for students. The lessons span a wide range of topics including an introduction to bicycling and walking issues, planning and designing for bicycle and pedestrian facilities, supporting elements and programs, and international approaches to bicycle and pedestrian transportation. This is the second edition of the *Student Workbook*; the first edition was published as *Report No. FHWA-RD-99-198*.

Aside from this *Student Workbook*, where should I start looking to find key resources on bicycle and pedestrian transportation?

Bicycle and Pedestrian Program, FHWA Office of Planning, Environment, and Realty:

Useful resources for State and local government program managers and practitioners.

<http://www.fhwa.dot.gov/environment/bikeped/index.htm>

Pedestrian/Bicycle Safety Program, FHWA Office of Safety: Information and resources aimed to improving pedestrian and bicyclist safety.

<http://safety.fhwa.dot.gov/programs/pedbike.htm>

Pedestrian and Bicycle Safety Research, FHWA Turner-Fairbank Highway Research Center: Information on issues and research related to improving pedestrian and bicyclist safety.

<http://www.tfhrc.gov/safety/pedbike/pedbike.htm>

The Access Board: Resources for accessible pedestrian design and public rights-of-way rulemaking.

<http://www.access-board.gov/>

Bicycle and Pedestrian Safety Information, National Highway Traffic Safety Administration: Bicycle and pedestrian safety information, research, and promotion.

<http://www.nhtsa.dot.gov/people/injury/pedbimot/ped/pedbike.html>

Pedestrian and Bicycle Information Center, University of North Carolina Highway Safety Research Center: Clearinghouse for information about health and safety, engineering, advocacy, education, enforcement and access and mobility.

<http://www.pedbikeinfo.org/>

National Center for Bicycling and Walking: Resources to create bicycle-friendly and walkable communities.

<http://www.bikewalk.org/>

National Transportation Library, Bureau of Transportation Statistics: Repository of materials from public and private organizations around the country.

<http://ntl.bts.gov/browse.cfm>

For Instructors:

Who is the audience for this course material?

The material in this *Student Workbook* is oriented toward a full course at the graduate level. As such, the lessons span a wide range of topics including an introduction to bicycling and walking issues, planning and designing for bicycle and pedestrian facilities, supporting elements and programs, and international approaches to bicycle and pedestrian transportation. The technical material in this *Workbook* is primarily intended to support classes offered in civil engineering and urban/regional planning departments. Nonetheless, the first edition material (in whole or in part) has also been incorporated into classes in public health, public policy and administration, and environmental design.

An overview lecture is available (at <http://safety.fhwa.dot.gov/pedbike/univcourse/>) for instructors who would like a succinct overview that can be incorporated into one or two lectures of an existing undergraduate or graduate course.

What other course development resources are available besides this *Student Workbook*?

The *Student Workbook* is one of three resources produced in an effort to stimulate the development of bicycle and pedestrian courses in universities nationwide:

- *Student Workbook* (this document): contains resource material and background reading for students, divided into 24 lessons.
- *Lesson-based Slideshows*: contains scripted slideshows with lesson objectives (in Microsoft PowerPoint®) that correspond to the 24 Student Workbook lessons (available at <http://safety.fhwa.dot.gov/pedbike/univcourse/>).
- *Overview Lecture*: contains a scripted slideshow (in Microsoft PowerPoint®) that can be incorporated as a one- or two-lecture overview in existing undergraduate or graduate transportation courses (available at <http://safety.fhwa.dot.gov/pedbike/univcourse/>).

How should I use these resources to develop a bicycle and pedestrian course?

The *Student Workbook* and the corresponding slideshows can be adopted in their current form, with a minimum level of effort, as the basis of a graduate course. Similarly, the overview lecture can be easily incorporated as one or two lectures in existing undergraduate courses.

Instructors are also encouraged to use any part of this material to form a curriculum that meets their needs. Most of the lessons are standalone in nature, with lessons of similar topics grouped into modules. A majority of the instructors using the first edition of these course materials have “personalized” the lessons for their courses by removing some lessons, adding supplemental material, reorganizing the lessons, and adding exercises and local activities to encourage student participation. For these reasons, a detailed syllabus or course outline has not been provided.

What are the key learning outcomes in this course material?

At the risk of oversimplifying a significant amount of course material, there are key learning outcomes for all students using this bicycle and pedestrian course material. For the *Student Workbook*, which targets a full graduate course:

- *Students should recognize the legitimacy of the bicycle and pedestrian modes in a balanced transportation system.*
- *Students should understand how policy, planning, and engineering practices can be improved to create a more balanced transportation system.*
- *Students should be familiar with basic policies, practices, tools, and design principles and know how to use them to create bicycle and pedestrian-friendly communities.*

The overview lecture, which targets one or two lectures in an undergraduate course, should address the first two learning outcomes listed above.

LESSON 1:

THE NEED FOR BICYCLE AND PEDESTRIAN MOBILITY

1.1 Introduction

This lesson explores the history of community design and its effect on bicycle and pedestrian travel. It explains the intricate relationship between transportation systems and land use, and how this relationship has evolved in the United States. This session also discusses the importance of planning for nonmotorized transportation modes as viable alternatives to the use of private automobiles, as it relates to quality of life, economic factors, health, safety, and welfare. Finally, the lesson explores the increasing level of interest in bicycle and pedestrian planning that has resulted from national legislation and grassroots support in local communities. The major sections of this lesson are as follows:

- 1.1 Introduction
- 1.2 How Cities Grow: A Historical Perspective
- 1.3 Modern Suburban Travel
- 1.4 Benefits of Bicycling and Walking
- 1.5 Government Commitment and Support
- 1.6 Public Support for Bicycling and Walking
- 1.7 Transportation and Planning Trends
- 1.8 Student Exercise
- 1.9 References and Additional Resources

1.2 How Cities Grow: A Historical Perspective

Perhaps more than any other factors, transportation modes have influenced the way cities grow and the forms they take. Before the advent of the automobile, cities were smaller and more compact in area and population.

Travel between cities was arduous. Transport of goods and materials was generally limited to short distances. People walked, rode horses or burros, or traveled in animal-drawn carts. Trips for work, shopping, socializing, and business were limited to walking distance for most people.

The introduction of the bicycle was a major innovation that substantially extended the range people could travel. Even today, the bicycle is a major mode of transportation in some countries of the world, such as China. It is used to haul heavy loads, pull trailers, and provide everyday transport. In these countries, the cost of driving is prohibitive for the average citizen. Per capita income is low, and the price of motor vehicle fuel and services is very high. Studies have shown that as per capita income rises, however, people switch to private motor vehicle ownership and the extent of walking and bicycling decreases.

In the United States of the 20th century, urban design reflects the influence of the motor vehicle as the dominant transportation mode. Many cities have historic city centers and older neighborhoods that were designed to accommodate pedestrians. In many cities, these historic areas are preserved and showcased as relics of earlier times. People visit them for the unusual experience of leaving their cars behind and walking around.

Neighborhoods and commercial areas that were designed in the post-World War II era are far less inviting to pedestrian travel. They typically lack sidewalks, and streets are wide and difficult to cross (see figure 1-1). People usually get in their cars to go to school, to work, or to buy groceries.

Much of this behavior is just plain habit. People don't think about walking or bicycling as being easy to do. Some of it, however, is a response to:

- Cities that concentrate all commercial development in large, single-use zones and that buffer these uses from nearby homes in ways that may screen out the lights and noise, but that also prevent pedestrian access. People can walk or bike to the shopping center, but only if they travel far out of their way and use major arterial streets.
- Cities with subdivision ordinances and street design standards that require wide streets and sometimes do not require sidewalks. The concept of multimodal or context-sensitive design—where motor traffic within neighborhoods is slowed and put on an equal footing with nonmotorized street users—is often not supported by standard design practices or is reserved only for special projects.



Figure 1-1. Photo. Wide suburban streets like this one were not built to accommodate or encourage walking.

- Suburban streets are built for higher-speed traffic than are the streets in older parts of town. Therefore, speed limits are higher on the new roads. There typically is no roadway space allocated to bicyclists. People perceive these streets as dangerous for bicycling, and they lack the skills and confidence to ride on them.
- Use of public transportation in suburban locations is often difficult. Effective public transit requires a higher density of users. Suburban schedules provide service at infrequent intervals. It is usually faster to drive than to take the bus.

- Often, barriers to bikes and pedestrians are created because developers and roadway designers (as well as the codes and regulations they are required to follow) are mainly concerned with motor vehicle traffic circulation (see figure 1-2). Bikes and pedestrians are generally not allowed at drive-up windows for banks, restaurants, dry cleaners, and similar establishments. Parking garages may allow direct access into adjoining office buildings, but what if the customer wants to park a bicycle or walk up a ramp to the street? Construction zones may put pedestrians and bicyclists at risk. Snow removal routinely piles snow along the curb, forcing bicyclists to the middle of traffic lanes. While these conditions are improving in many cities where new policies have been put in place, numerous barriers remain.



Figure 1-2. Photo. Many modern developments are designed to cater to automobile travel.

Source: Pedestrian and Bicycle Information Center (PBIC) Image Library, <http://www.pedbikeimages.org>⁽¹⁾

1.3 Modern Suburban Travel

Most modern suburban communities in the United States are not designed for bicycle and pedestrian travel. This was not always the case. In communities across the country that were built prior to 1950, there are remnants of walkable, bikable streets where destinations are closer to residential areas. More and more people are beginning to appreciate well-designed communities such as these, where bicycling is enjoyable and the streets are lined with trees and sidewalks (the trend toward neotraditional neighborhood design reflects this—see lesson 6). The following provides one view of how suburban residential design has changed in America:

Over the last 40 years, as automobiles replaced streetcars, the need for locating houses close to the streetcar stop disappeared. Retail business concentrated near the residential subdivisions and apartment complexes, curbs and sidewalks, symbols of a pedestrian and streetcar-oriented world, became expensive and unnecessary features in this new, low-density environment. House lots became wider to accommodate garages, and houses themselves were set back from the street to reduce the noise and nuisance of passing cars.⁽²⁾

Urban design practices have come full circle as planners and engineers have begun to recognize the value in providing neighborhoods and commercial areas that are pedestrian- and bicycle-friendly. In many cities and towns, zoning ordinances and subdivision design regulations have been revised to ensure that new developments are designed to encourage walking and bicycling.

1.4 Benefits of Bicycling and Walking

Increased levels of bicycling and walking would result in significant benefits in terms of health and physical fitness, the environment, and transportation-related effects. Research has shown that even low to moderate levels of exercise, such as regular bicycling or walking, can reduce the risk of coronary heart disease, diabetes, stroke, and other chronic diseases; help reduce health care costs; contribute to greater functional independence in later years of life; and improve quality of life at every stage. A summary of benefits is provided below:

Transportation System Benefits

- According to the 2001 NHTS, nearly half of all travel trips taken in the United States are 4.8 kilometers (km) [3 miles (mi)] or less in length; 28 percent are less than 1.6 km (1 mi).⁽³⁾ By taking advantage of the opportunity to convert short automobile trips to bicycling and walking, communities can reap significant benefits from healthier air and reduced traffic congestion.
- According to *Plan B, The Comprehensive State Bicycle Plan for Minnesota*, the American public saves from 3 to 14 cents for every automobile km (5 to 22 cents per mi) displaced by walking and bicycling through reduced pollution, oil import costs, and costs from congestion such as lost wages and time on the job.⁽⁴⁾

Environmental Benefits

- Increased levels of bicycling and walking can play an important role in reducing air pollution. According to the Environmental Protection Agency (EPA), approximately 160 million tons of pollution are emitted into the air each year in the United States. A serious threat to public health, air pollution contributes to the deaths of 70,000 people nationwide each year, according to an estimate from the Harvard School of Public Health.
- Short auto trips produce far more pollution per mile than longer trips. According to the Federal Highway Administration (FHWA) publication, *Transportation Air Quality: Selected Facts and Figures*, “starting the car cold generates about 16 percent more NO_x and 40 percent more CO than starting the car when it is warm.”⁽⁵⁾

Economic Benefits

- For many households, a motor vehicle is typically one of the highest expenses after housing. The option of bicycling can improve mobility for people who cannot afford to own and operate a motor vehicle, and would allow some households with autos to own one vehicle instead of two.

- Pedestrian and bicycle transportation allows people to incorporate physical activity into their daily lives (see figure 1-3), which reduces health care costs and morbidity rates.



*(This picture shows bicyclists not wearing helmets.
FHWA strongly recommends that all bicyclists wear helmets.)*

Figure 1-3. Photo. There are many economic benefits to building bicycle and pedestrian facilities like this shared-use path.

Source: PBIC Image Library, <http://www.pedbikeimages.org>⁽¹⁾

- Outdoor activities such as bicycling and walking are the most popular activities for people on vacation from work. They are more popular than visiting museums or national parks, doing beach and water activities, and shopping.
- Businesses invest in locations that have a high quality of life. Corporate employers have an easier time attracting highly skilled workers to these locations.
- According to the National Bicycle and Pedestrian Clearinghouse, trails and greenways can have a positive effect on the value of nearby properties.⁽⁶⁾ Recent studies of the preferences of new homebuyers indicate that there is a demand for more livable communities and, specifically, better bicycle and pedestrian facilities in the vicinity.

Quality of Life Benefits

- Pedestrians add to the ambience and security of streets.
- Providing a livable community is a necessary part of attracting and keeping businesses, and ensuring local communities remain competitive in the 21st century.

Health Benefits

- A number of research studies have shown a correlation between the built environment and the amount of routine physical activity, such as regular walking trips. A study published in the September 2003 issue of the *American Journal of Health Promotion* titled “Relationship between Urban Sprawl and Physical Activity, Obesity, and Morbidity” found that people living in sprawling counties “were likely to walk less, weigh more, and have greater prevalence of hypertension than those living in compact counties.”⁽⁷⁾ An earlier study published in the *American Journal of Preventive Medicine* showed a direct relationship between the amount of walking and the age of the home in which a person lives, as a proxy for the style of urban residential development that is common in older versus newer communities.⁽⁸⁾ People who lived in older homes were found to walk more.
- Research conducted in 1999 by the Centers for Disease Control and Prevention found that “obesity and overweight are linked to the nation’s number one killer—heart disease—as well as diabetes and other chronic conditions.” The report also states that one reason for Americans’ sedentary lifestyle is that “walking and cycling have been replaced by automobile travel for all but the shortest distances.”⁽⁹⁾
- Today, there are nearly twice as many overweight children and almost three times as many overweight adolescents as there were in 1980. Results of the 1999 National Health and Nutrition Examination Survey showed that 13 percent of children and adolescents were overweight.⁽¹⁰⁾
- Numerous studies have shown tremendous benefits from even a brief amount of light but routine exercise each day (see figure 1-4). Bicycling or walking to the store, school, or work also provides a time-efficient way of attaining the U.S. Surgeon General’s recommended daily allowance of physical exercise.
- Pedestrian and bicycle transportation offers more opportunities for people to socialize than driving alone in automobiles.

Given these many benefits, the result of a 1991 Harris Poll is not surprising. While only 5 percent of respondents currently walk or bicycle as their primary means of transportation, two-and-a-half times this number would prefer to walk or bicycle if better facilities were available.⁽¹¹⁾



Figure 1-4. Photo. Walking can have a tremendous health benefit.

Source: PBIC Image Library, <http://www.pedbikeimages.org>,⁽¹⁾

1.5 Government Commitment and Support

Government support at the Federal, State, and local levels is critical to ensuring that the transportation system accommodates bicycling and walking. Whereas individuals and private organizations can accomplish much in increasing public awareness, identifying needs, etc., the creation of safer and more appealing places to bicycle and walk is primarily a responsibility of government. This is accomplished not only through direct improvements to the roadway environment, but also through planning, policymaking, and other government activities. Support and commitment at every level of government are thus the keys to significant increases in bicycling and walking as modes of transportation.

Leading the way in Federal support for bicycling and walking was the Intermodal Surface Transportation Efficiency Act (ISTEA). That act initiated a major policy shift in Federal funding priorities in the United States by making Federal funds much more accessible for State and local bicycling and walking facilities and programs.⁽¹²⁾ Subsequent Federal transportation bills have strengthened the emphasis on improving conditions for bicycling and walking.

Following the adoption of ISTEA, the U.S. Department of Transportation (USDOT) published the National Bicycling and Walking Study (NBWS) in 1994.⁽¹³⁾ NBWS translated the recognition of nonmotorized travel embodied in ISTEA into two specific goals: to double the percentage of trips made by foot and bicycle while simultaneously reducing the number of crashes involving bicyclists and pedestrians by 10 percent.

The Transportation Equity Act for the 21st Century (TEA-21), signed into law on June 9, 1998, carried forward the same programs for bicycling and walking established in ISTEA and included several new and stronger directives. TEA-21 amended existing surface transportation legislation by including a number of important policy statements:

- State and metropolitan planning organization (MPO) long-range plans are to “provide consideration of strategies that will increase the safety and security of the transportation system for motorized and nonmotorized users.”
- Bicyclists and pedestrians shall be given “due consideration” in State and MPO plans.
- Bicycle and pedestrian facilities are to “be considered, where appropriate, with all new construction and reconstruction of transportation facilities.”

TEA-21 also amended Federal transportation law to require the Secretary of Transportation to ensure that bicycle and pedestrian linkages are maintained and improved, stating that:

- “The Secretary of Transportation shall not approve any project or take any regulatory action that will result in the severance of an existing major route, or have an adverse impact on the safety of nonmotorized transportation traffic and light motorcycles, unless such project or regulatory action provides for a reasonable alternate route or such a route already exists.”
- “In any case where a highway bridge deck being replaced or rehabilitated with Federal financial participation is located on a highway on which bicycles are permitted to operate at each end...and the Secretary determines that the safe accommodation of bicycles can be achieved at reasonable cost, the bridge shall be so replaced.”

In February 1999, FHWA issued program guidance regarding the bicycle and pedestrian provisions of Federal surface transportation legislation. The program guidance and accompanying transmittal

memorandum are extremely supportive of bicycling and walking and clearly establishes that these modes are an important component of the transportation system, stating that:^(14,15)

- “To varying extents, bicyclists and pedestrians will be present on all highways and transportation facilities where they are permitted and it is clearly the intent of TEA-21 that all new and improved transportation facilities be planned, designed, and constructed with this fact in mind.”
- “We expect every transportation agency to make accommodation for bicycling and walking a routine part of their planning, design, construction, operations, and maintenance activities.”
- “Bicycling and walking ought to be accommodated, as an element of good planning, design, and operation, in all new transportation projects unless there are substantial safety or cost reasons for not doing so.”

The program guidance also clarified the meaning of “due consideration,” stating that:⁽¹⁵⁾

- It is to be presumed that bicyclists and pedestrians will be accommodated in the design of new and improved transportation facilities.
- The decision NOT to accommodate them should be the exception, not the rule.
- Any circumstances for denying access through design or prohibition must be exceptional.

States have responded to the challenges of the Federal legislation, and many are already ahead of its requirements. As mandated, bicycle and pedestrian coordinators are in place in all 50 States, and some State departments of transportation (DOTs) maintain programs that are staffed with several professionals who focus solely on bicycle and pedestrian planning and design issues. Florida DOT is one of the leaders in this regard, with six staff members who spend 80 percent or more of their time on pedestrian- or bicycle-related work, two who spend 50 percent or more in this area, and many additional staff who spend a smaller portion of time on pedestrian and bicycle issues.

MPOs and individual communities have also responded to the mandates and opportunities of the Federal legislation. The infusion of Federal funding for bicycle and pedestrian projects has galvanized local commitments of funding throughout the country. FHWA has estimated that in the 18 years prior to ISTEA, a total of \$41 million of Federal funds were spent on bicycling and walking, for an average of \$2.3 million per year. By the year 2003, that figure had risen to \$422 million per year.

This infusion of funding has fueled a large rise in the number of new shared-use paths, bike lanes on urban streets, and sidewalk improvements throughout the country. More and more professionals have become involved in working on transportation issues related to bicycling and walking. The Association of Pedestrian and Bicycle Professionals, founded in 1995, reported a membership of over 450 professionals by the year 2003.

Funding Sources for Bicycle and Pedestrian Projects

Bicycle and pedestrian projects are broadly eligible for funding from almost all the major Federal-aid highway, transit, safety, and other programs. Bicycle projects must be “principally for transportation, rather than recreation, purposes” and must be designed and located pursuant to the transportation plans required of States and MPOs.

National Highway System funds may be used to construct bicycle transportation facilities and pedestrian walkways on land adjacent to any highway on the National Highway System, including Interstate highways.

Surface Transportation Program (STP) funds may be used for either the construction of bicycle transportation facilities and pedestrian walkways or nonconstruction projects (such as maps, brochures, and public service announcements) related to safe bicycle use and walking. The modification of public sidewalks to comply with the Americans with Disabilities Act also is eligible for STP funds.

Ten percent of each State's annual STP funds are set aside for Transportation Enhancement Activities (TEAs). The law provides a specific list of activities that are eligible TEAs and this includes "provision of facilities for pedestrians and bicycles, provision of safety and educational activities for pedestrians and bicyclists," and the "preservation of abandoned railway corridors (including the conversion and use thereof for pedestrian and bicycle trails)."

Another 10 percent of each State's STP funds are set aside for the Hazard Elimination and Railway-Highway Crossing programs, which address bicycle and pedestrian safety issues. Each State is required to implement a Hazard Elimination Program to identify and correct locations that may constitute a danger to motorists, bicyclists, and pedestrians. Funds may be used for activities such as a survey of hazardous locations, projects on any publicly owned bicycle or pedestrian pathway or trail, or any safety-related traffic calming measure. Improvements to railway-highway crossings "shall take into account bicycle safety."

Congestion Mitigation and Air Quality Improvement Program funds may be used for either the construction of bicycle transportation facilities and pedestrian walkways or nonconstruction projects (such as maps, brochures, and public service announcements) related to safe bicycle use. Project applications for these funds must demonstrate an air quality benefit.

Recreational Trails Program funds may be used for all kinds of trail projects. Of the funds apportioned to a State, 30 percent must be used for motorized trail uses, 30 percent for nonmotorized trail uses, and 40 percent for diverse trail uses (any combination).

Provisions for pedestrians and bicyclists are eligible under the various categories of the Federal Lands Highway Program in conjunction with roads, highways, and parkways. Priority for funding projects is determined by the appropriate Federal Land Agency or tribal government.

National Scenic Byways Program funds may be used for "construction along a scenic byway of a facility for pedestrians and bicyclists."

Job Access and Reverse Commute Grants are available to support projects, including bicycle-related services, designed to transport welfare recipients and eligible low-income individuals to and from employment.

Federal Transit Program (FTP)

Title 49 U.S.C. (as amended by TEA-21) allows the Urbanized Area Formula Grants, Capital Investment Grants and Loans, and Formula Program for Other Than Urbanized Area transit funds to be used for improving bicycle and pedestrian access to transit facilities and vehicles. Eligible activities include investments in "pedestrian and bicycle access to a mass transportation facility" that establishes or enhances coordination between mass transportation and other transportation.

TEA-21 also amended Title 49 to create a Transit Enhancement Activity program with a 1 percent set-aside of Urbanized Area Formula Grant funds designated for, among other things, pedestrian access and walkways, and "bicycle access, including bicycle storage facilities and installing equipment for transporting bicycles on mass transportation vehicles."

Highway Safety Programs

Pedestrian and bicyclist safety remain priority areas for State and Community Highway Safety Grants funded by the Section 402 formula grant program. A State is eligible for these grants by submitting a Performance Plan (establishing goals and performance measures for improving highway safety) and a Highway Safety Plan (describing activities to achieve those goals).

Research, development, demonstrations, and training to improve highway safety (including bicycle and pedestrian safety) are carried out under the Highway Safety Research and Development (Section 403) program.⁽¹⁶⁾

1.6 Public Support for Bicycling and Walking

Regardless of the commitment of Federal, State, and local governments to bicycling and walking transportation, and regardless of the walkability or bikability of our cities and towns, the full potential of bicycling and walking as transportation modes will not be realized if the public is unable to embrace them as viable transportation options. Both government and the private sector can play key roles here by working to increase public awareness of bicycling and walking and actively promoting their use. Programs to increase levels of nonmotorized transportation, including innovative transportation demand management plans, bike-to-work activities, Safe Routes to Schools programs, and other promotional efforts, all can help to popularize nonmotorized transportation.

If recent survey results are any indication, the public already strongly supports increased travel options. National transportation polls consistently show that adults in the United States want more opportunities to bicycle and walk for recreation and transportation. A 1991 Harris Poll showed that 46 percent of adults age 18 and older—82 million Americans—say they would sometimes commute to work by bicycle if safe bicycle lanes were available. Similarly, 59 percent of the respondents reported that they would walk, or walk more, if there were safe, secure designated paths or walkways. Respondents also indicated that they want their governments to enhance their opportunities to walk and bicycle.⁽¹¹⁾

A 2002 poll conducted by the Bureau of Transportation Statistics and the National Highway Traffic Safety Administration (NHTSA) found that 27 percent of adults ride a bicycle at least once a month during the summer months, and found that respondents support the installation of more bike lanes, new paths, and better lighting and signals to support bicycle trips.⁽¹⁷⁾ In a poll conducted by Belden Russonello & Stewart that same year, 53 percent of respondents supported higher levels of Federal spending on bicycle facilities, even if it means less funding is available for new road construction.⁽¹⁸⁾

1.7 Transportation and Planning Trends

Thus far, this lesson has described the challenges and potential for increasing nonmotorized travel in the United States. Public interest and financial support for bicycling and walking has led to improvement projects throughout the country, from big cities to small towns and in rural areas as well. Although progress is slow and the problems often seem insurmountable, several trends in transportation planning point to a promising future for bicycling and walking. New energy, funding, and political support are being given to programs that reduce reliance on the private motor vehicle and encourage bicycling and walking. Here are a few examples of these trends:

- **DOTs at the State level are adopting policies that support nonmotorized transportation.**

When ISTEA was enacted by Congress in 1991, many State DOTs were initially reticent about including facilities for bicycles and pedestrians during roadway improvement projects. Today, a

number of States are leading the way in establishing policies that *require* inclusion of pedestrian and bicycle accommodations in each road construction or reconstruction project. America Bikes, an advocacy organization established to influence national transportation policy, established the concept of complete streets (see figure 1-5), and defines them in the following way:



Figure 1-5. Photo. Many State DOTs are adopting “complete streets” policies.

Source: PBIC Image Library, <http://www.pedbikeimages.org>⁽¹⁾

Complete streets provide choices to the people who live, work, and travel on them. Pedestrians and bicyclists are comfortable using complete streets. A network of complete streets improves the safety, convenience, efficiency, and accessibility of the transportation system for all users. Every road project should create complete streets.⁽¹⁹⁾

Examples of States with complete streets policies include California, Florida, Kentucky, Oregon, South Carolina, Tennessee, and Virginia. A number of other States are in the process of developing new guidance in their roadway design manuals that incorporates better accommodations for pedestrians and bicycles, including Massachusetts, New Jersey, and Pennsylvania.

The concept of complete streets includes provisions to make streets accessible for all users, including those with disabilities. Increasing the accessibility for users with disabilities increases the accessibility for all users.

- **Trends in community design and redevelopment are moving to accommodate and encourage walking and bicycling.**

In all parts of the country, there has been increased focus on pedestrian-oriented design. Once-deteriorating downtowns are being rediscovered and revitalized, often with a strong pedestrian emphasis. In some communities, this new focus began with the introduction of new urbanist developments and has then led to a more comprehensive reexamination of zoning and subdivision regulations that have traditionally favored automobile access. Communities in every State have begun the labor-intensive process of rewriting their development guidelines to either

encourage or require mixed-use development and higher densities. Communities across the country increasingly require developers to provide sidewalks and bikeways, and decreasingly fewer planning boards allow exemptions from these requirements.

Many planning processes are recognizing and addressing the need for coordination and cooperation with other professional disciplines as well as with citizen groups, city maintenance departments, police officers, school officials, and others. Creating pedestrian- and bicyclist-friendly cities takes cooperation and a big-picture approach backed by the power to put forward adoptable recommendations with policy or regulatory status.

- **There is a surge of interest in Safe Routes to Schools programs.**

Galvanized by the success of Walk-to-School Day—a national promotional event held in early October of each year—State and local governments across the country are initiating Safe Routes to School programs (see figure 1-6). These programs are typically grassroots efforts among concerned parents, teachers, and community planners to improve walking conditions near schools, educate children on safe walking and bicycling skills, and promote walking as a healthy alternative.



Figure 1-6. Photo. Safe Routes to School programs are being implemented throughout the U.S.

Source: PBIC Image Library, <http://www.pedbikeimages.org>⁽¹⁾

A growing number of State legislatures throughout the United States have passed legislation aimed at supporting Safe Routes to Schools efforts. This has spurred a variety of pilot programs, the development of guidebooks (such as those developed for use in California, Delaware, Florida, and Maryland), and national legislation. The growing momentum of these programs has been boosted by positive results in two communities that served as national pilot programs:

- **Marin County, CA:** A combination of funding was used to establish the pilot Safe Routes program in Marin County, including funds from the County, NHTSA, several private foundations, and the Bicycle Coalition. Traffic congestion was a considerable issue for this Safe Routes program—an estimated 21 percent of morning rush hour traffic consisted of parents dropping children off at schools. The program grew from an initial nine pilot schools and 1,600 students in 2000 to 23 schools and 12,000 students in 2003. The results were

impressive: a 57 percent increase in children walking and biking, and a 29 percent decrease in children arriving by car.

- Arlington, MA: This program also used a combination of funding and support from private corporations such as New Balance, the American Automobile Association (AAA), and the Robert Wood Johnson Foundation. Public sources included the City of Boston, Massachusetts Highway Department, and the National Park Service. The program began with three pilot schools in 2000, and expanded to several more schools in 2001–2003. At one elementary school, 38 percent of students walked prior to 2000. By June 2002, 56 percent of students walked to that school.

- **In urban and suburban areas, a network of shared-use paths and onroad bikeways for nonmotorized transportation is growing.**

Trail systems provide continuous, scenic, and grade-separated access to major destinations using canal banks, flood control channels, river corridors, parks, and greenbelts. Built to current design standards, these trails can serve many types of users for many different trip purposes. Cities and towns of all sizes have continued to add miles of shared-use paths, forming a growing network of trails throughout the U.S. Projects like the East Coast Greenway—a proposed urban off-road trail extending from Maine to Florida—have galvanized local efforts to eliminate gaps in their trail networks, improve trail/roadway intersections, and develop guide maps. In urban areas such as Portland, OR, and Washington, DC, census data show higher levels of bicycle commuting in census tracts that lie along trails and onroad bikeways.

- **Growing trends in roadway design toward slower operating speeds are making it less comfortable to operate motorized vehicles at high speeds in residential areas.**

State and local DOTs have begun to reexamine longstanding roadway design practices that have favored generous lane widths and faster design speeds. There is a growing recognition among transportation engineers that urban roadways must be designed to accommodate multiple users, and therefore intersections should be more compact and provide refuge areas for pedestrian crossings. Traffic calming principles have become mainstream in many transportation departments. See lesson 20 for a full explanation of the traffic calming techniques.

- **Professional associations increasingly advocate walking and bicycling.**

Associations such as the American Association of State Highway and Transportation Officials (AASHTO), Transportation Research Board (TRB), the Institute of Transportation Engineers (ITE), and the American Society of Civil Engineers (ASCE) are putting more and more positive energy into support for bicycle and pedestrian transportation.

They are working to educate their members about design planning, construction practices, and related issues. ITE, for example, has published manuals on traffic calming, supports traditional neighborhood design, and is adding new chapters on walking and bicycling solutions to its major handbook and other publications. AASHTO has initiated updates to the *Guide for the Development of Bicycle Facilities* and is in the process of publishing its first national pedestrian guideline. In addition, engineers and planners in the bicycle and pedestrian field have established their own professional organization—the Association of Pedestrian and Bicycle Professionals (APBP). This organization promotes excellence in the emerging professional discipline of pedestrian and bicycle transportation.

- **There is a trend toward greater public involvement in transportation decisions.**

The public has become more involved in transportation planning and policy, especially on the local and State levels (see figure 1-7). Federal transportation legislation and a trend toward citizen activism are leading to the formation of bicycle and pedestrian advisory councils in many areas.

Combined with existing community organizations, clubs, and advocacy networks, such councils play growing roles in transportation and land use decisions.

1.8 Student Exercises

The following ideas are suggested for student exercises.

Exercise A

Part 1

Take photographs of both good and bad locations to bicycle and walk in your community. Photographs may document conditions in several locations or within one particular development (commercial or residential). Your photo log should capture the overall environment (such as streetscape), specific barriers and/or good features, and general land use relationships to the transportation facility. For each photograph, prepare a short writeup explaining the problems or positive features you inventoried.



Figure 1-7. Photo. There are growing trends in public involvement in local transportation planning processes.

Source: PBIC Image Library, <http://www.pedbikeimages.org>⁽¹⁾

Part 2

Using the specific locations you documented in part 1, conduct an evaluation of engineering issues related to the following facility design aspects:

1. **Need for bicycle/pedestrian facilities.** How would you establish the need for facilities, whether the existing ones or proposed improvements? What data would you collect? What type(s) of

analysis procedures or comparisons would be useful in assessing need? If you documented existing facilities in your photographs, how would you demonstrate effectiveness to detractors who call money spent on pedestrian and bicycles facilities a waste of resources? Please develop some proposed guidelines within the context of effective and reasonable public policy for use by a local agency in addressing issues related to bicycle and pedestrian facilities.

2. **Incorporation of needed facilities in new design.** Describe how any deficiencies you noted in your photo logging exercise could have been addressed if pedestrian and/or bicycle facilities were included in the original design and construction. Tabulate and evaluate the associated impacts. If you documented existing designs, describe and quantify impacts associated with accommodating pedestrians and/or bicycles in the facility/facilities you photographed.
3. **Incorporation of needed facilities in retrofit design.** Assuming that you documented locations deficient for pedestrian and bicycle travel, list and describe possible ways to rectify and retrofit existing facilities so that these locations can more readily accommodate pedestrian and/or bicycle travel modes.

Exercise B

Conduct an Internet search to find local land use planning procedures, and document your findings in a one-page report, citing your sources. Critique the organization's pedestrian/bicycle planning procedures given the new Federal emphasis on pedestrian/bicycle issues.

Exercise C

List ten primary and secondary health and societal benefits of nonmotorized transportation. Then write a paragraph for each benefit that further develops each idea listed.

1.9 References and Additional Resources

The references for this lesson are:

1. Image Library, PBIC, available online at <http://www.pedbikeimages.org>, accessed May 6, 2004.
2. Untermann, Richard K., *Linking Land Use and Transportation: Design Strategies to Serve HOVs and Pedestrians*, Washington State Transportation Commission, Olympia, WA, 1991.
3. 2001 NHTS, available online at http://www.bts.gov/programs/national_household_travel_survey/, accessed August 12, 2005.
4. *Plan B, The Comprehensive State Bicycle Plan for Minnesota*, Minnesota Department of Transportation, February 1992.
5. *Transportation Air Quality: Selected Facts and Figures*, FHWA. Washington, DC, January 2002.
6. National Center for Bicycling and Walking, available online at <http://www.bikewalk.org/index.htm>, accessed August 12, 2005.

7. Ewing R., Schmid T., Killingsworth R., Zlot A. and Raudenbush S., "Relationship Between Urban Sprawl and Physical Activity, Obesity and Morbidity," *American Journal of Health Promotion*, volume 18, no. 1, September 2003.
8. Berrigan, D. and R.P. Troiano, "The Association Between Urban Form and Physical Activity in U.S. Adults," *American Journal of Preventive Medicine*, volume 23, issue 2, supplement 1, August 2002.
9. Centers for Disease Control and Prevention, Atlanta, GA, 1999.
10. 1999 National Health and Nutrition Examination Survey, available online at <http://www.cdc.gov/nchs/nhanes.htm>, accessed August 12, 2005.
11. Harris Poll Data published by *Bicycling Magazine*, April 1991 and by Rodale Press, 1992.
12. *Intermodal Surface Transportation Efficiency Act of 1991*.
13. *National Bicycling and Walking Study*, FHWA, Publication No. FHWA-PD-94-023, Washington, DC, 1994, available online at <http://www.fhwa.dot.gov/environment/bikeped/>, accessed April 26, 2004.
14. *Transmittal of Guidance on Bicycle and Pedestrian Provisions of the Federal-aid Program*, FHWA, Washington, DC, February 24, 1999, available online at <http://www.fhwa.dot.gov/environment/bikeped/bp-guid.htm>, accessed April 26, 2004.
15. *FHWA Guidance—(February 24, 1999: Bicycle and Pedestrian Provisions of Federal Transportation Legislation*, FHWA, Washington, DC, February 24, 1999, available online at <http://www.fhwa.dot.gov/environment/retrails/guidance.htm>, accessed April 26, 2004.
16. *A Summary of Bicycle and Pedestrian Provisions of the Federal-aid Program*, FHWA, Publication No. FHWA-PD-98-049, Washington, DC, 1998.
17. *2002 National Survey of Pedestrian and Bicyclist Attitudes and Behaviors*, Bureau of Transportation Statistics, available online at <http://www.bts.gov/>, accessed August 12, 2005.
18. *Americans' Attitudes Toward Biking*, Belden, Russonello & Stewart, April 2003, available online at <http://www.americabikes.org/images/resource/media/summary%20of%20stats.doc>, accessed August 12, 2005.
19. America Bikes Web site, 2004, available online at <http://www.americabikes.org/>, accessed April 28, 2004.

Additional resources for this lesson include:

- Appleyard, Donald, *Livable Streets*, University of California Press, Berkeley, CA, 1981.
- *Complete Streets Fact Sheet*, League of American Bicyclists, Washington, DC, 2004.
- FHWA Bicycle and Pedestrian Program, 2005, available online at <http://www.fhwa.dot.gov/environment/bikeped/index.htm>, accessed March 21, 2005.
- Jacobs, Allan, *Great Streets*, The MIT Press, Cambridge, MA, 1993.

- PBIC: Policy and Planning Page, 2004, available online at <http://www.walkinginfo.org/pp/index.htm>, accessed April 26, 2004.
- Whyte, William H., *City: Rediscovering the Center*, Doubleday, New York, NY, 1989.

LESSON 2:

BICYCLING AND WALKING IN THE UNITED STATES TODAY

2.1 Introduction

It is generally acknowledged that nonmotorized travel modes are not being used as extensively as they could be in the United States. This lesson describes current levels of bicycle and pedestrian activity, and it specifically examines the reasons why bicycling and walking are not used more widely as travel modes. This lesson explores patterns of pedestrian and bicycle travel, particularly as they relate to design issues and allocation of right-of-way space.

In order to adequately plan and design for bicycles and pedestrians, it is important to understand current patterns of travel as well as the desire for increased mobility. Although children, older adults, and people with disabilities make up a large percentage of the population (up to 37 percent of most States), their needs are seldom adequately considered in transportation system planning and design (see figure 2-1). Increasing transportation accessibility for users with disabilities increases the accessibility for all users. This lesson discusses these and other pertinent issues that affect bicycle and pedestrian travel in the United States today.⁽¹⁾ The major sections of this lesson are as follows:

- 2.1 Introduction
- 2.2 Current Levels of Bicycling and Walking
- 2.3 Factors Influencing the Decision to Bicycle or Walk
- 2.4 Potential for Increasing Bicycling and Walking
- 2.5 Need for Action: Pedestrians and Bicyclists at Risk
- 2.6 Student Exercise
- 2.7 References and Additional Resources



Figure 2-1. Photo. Sidewalks must be designed to serve people of all abilities.

Source: PBIC Image Library, <http://www.pedbikeimages.org>⁽²⁾

2.2 Current Levels of Bicycling and Walking

A number of surveys confirm that bicycling and walking are activities enjoyed by increasing numbers of Americans of all ages:

- According to the Travel Industry Association of America, 27 million travelers took bicycling vacations between 1997 and 2002 (ranks in the top three most popular outdoor vacation activities).⁽³⁾
- According to a National Sporting Goods Association (NSGA) survey, exercise walking drew 79.5 million participants in 2003, making it by far the most popular recreational activity in the United States. Bicycling ranks seventh on the list, with 36.3 million participants in 2003.⁽⁴⁾

Bicycling and walking are clearly popular activities, whether for sport, recreation, exercise, or simply for relaxation and enjoyment of the outdoors. As the following surveys indicate, however, their potential as modes of transportation is just beginning to be realized.

2001 NHTS

The primary source of information on utilitarian as well as recreational bicycling and walking in the United States is the NHTS.⁽⁵⁾ The survey is conducted approximately every 5 to 7 years, with the most recent survey taken in 2001. NHTS survey data are collected from a sample of U.S. households and expanded to provide national estimates of trips and miles by travel mode, trip purpose, and a host of household attributes (see figure 2-2).

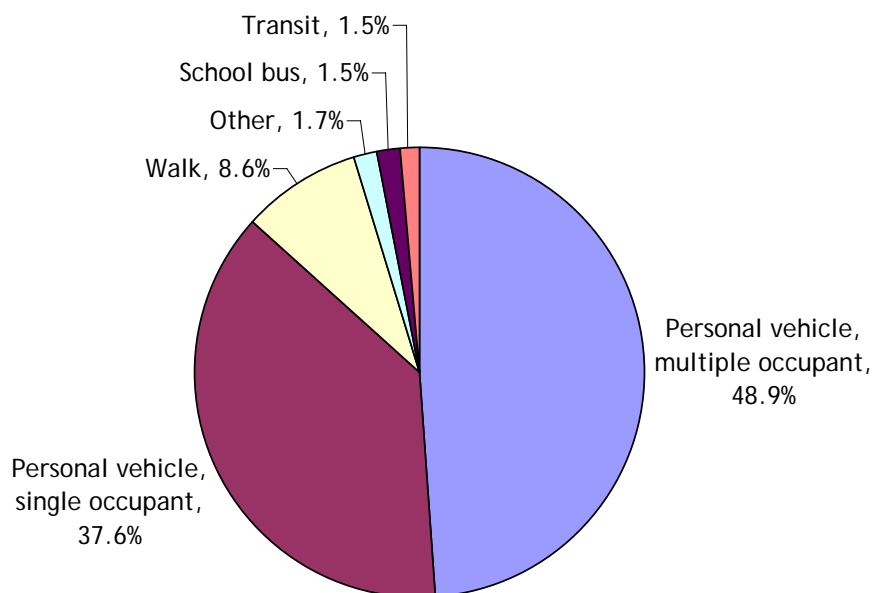

Figure 2-2. Chart. Transportation mode data from the 2001 NHTS.

Source: Highlights of the 2001 NHTS⁽⁵⁾

The 2001 NHTS collected travel data from a national sample of approximately 66,000 households. The NHTS was conducted using computer-assisted telephone interviewing (CATI) technology. Each household in the sample was assigned a specific 24-hour “Travel Day” and kept diaries to record all travel

by all household members for the assigned day. A 28-day travel period was assigned to collect longer-distance travel [over 80.5 km (50 mi) from home] for each household member and includes information on long commutes, airport access, and overnight stays.⁽⁵⁾

Results revealed that 8.6 percent of all trips were by walking and 0.9 percent by bicycling. The survey techniques used for the 2001 NHTS varied in their measurement of walking trips; thus, what appears to be an increase in walking trips from the 1995 Nationwide Personal Transportation Survey (NPTS) (which indicated that walking trips were 5.4 percent of total trips) may in fact be due to the change in sampling methodologies.⁽⁶⁾

In 2003, the Eno Transportation Foundation profiled transportation trends in an article in the *Transportation Quarterly* titled “Socioeconomics of Urban Travel: Evidence from the 2001 NHTS.” In it, the authors make the following conclusions regarding walking:⁽⁷⁾

Walking is probably the most ignored mode of transport, both in general as well as in reference to its importance among the disadvantaged . . . walking accounts for 16.2 percent of the trips by the poor, 12.6 percent of trips by blacks, and 11.8 percent of the trips of Hispanics. Yet in the United States, facilities for pedestrians are often inconvenient or nonexistent, leading to fatality rates per mile traveled 36 times higher than for occupants of cars and light trucks. The lack of pedestrian safety especially affects minorities and the poor. For example, blacks account for 20 percent of all pedestrian deaths, almost twice their 12 percent share of the total population.

There are significant regional differences in amount of walking trips that occur in different geographic regions of the United States. As calculated by the authors of the *Transportation Quarterly* article, table 2-1 shows regional variations in modal shares for transit, walking, and bicycling.⁽⁷⁾ As expected, nonmotorized modes are used to a greater extent in areas of the country with more extensive public transit systems and in cities that are oriented to transit use.

Table 2-1. Regional variations in modal shares for transit, walking, and bicycling.
(percentage of trips by mode)

Source: Highlights of the 2001 NHTS⁽⁵⁾

Mode of Transportation	New England	Middle Atlantic	East North Central	West North Central	South Atlantic	East South Central	West South Central	Mountain	Pacific
Total Transit	1.8	5.8	1.3	0.6	1.6	0.4	0.7	0.8	2.2
Bus and Light Rail	0.7	3.0	0.9	0.5	1.2	0.4	0.7	0.8	2.0
Metro/Subway/ Heavy Rail	0.9	2.3	0.2	0.0	0.3	0.0	0.0	0.0	0.1
Commuter Rail	0.3	0.5	0.2	0.0	0.1	0.0	0.0	0.0	0.1
Total Nonmotorized	11.0	16.7	9.5	7.3	8.5	6.4	7.1	9.5	11.7
Walk	10.3	15.8	8.6	6.6	7.6	6.0	6.3	8.7	10.6
Bicycle	0.7	0.8	0.9	0.7	0.9	0.4	0.8	0.8	1.1

Note: Values in table represent percent of total trips by mode indicated.

As with previous federally sponsored transportation surveys, the 2001 NHTS collected data on trip purpose and trip length. Results show that more than half of the bicycle trips and a third of the walking trips are for social or recreational purposes. Family and personal business travel, along with school and

church-related travel, were also significant contributors. The average length of a travel trip is 0.97 km (0.6 mi) for walking and 3.2 km (2.0 mi) for bicycling.

Other National Surveys

A second source of information on utilitarian bicycling and walking is the U.S. Census “Journey to Work” survey.⁽⁸⁾ The survey is conducted every 10 years and is targeted toward participants in the work force age 16 or older. It is important to note that the U.S. Census survey reports on travel to and from work only, excluding trips to school, shopping, and other frequent destinations. Data are collected for a one-week period during the last week in March, making it likely that bicycling and walking trips are underreported for many parts of the country due to cold weather. Moreover, only the predominant transportation mode is requested, so that occasional bicycling and walking trips as well as bicycling and walking trips, made to access transit or other travel modes, are not recorded.

With these limitations in mind, in 2000, an estimated 3.8 million people (3.9 percent of all workers) commuted to work by walking, and just under one-half million (0.4 percent) commuted by bicycle. These are national averages; some cities had much higher percentages of people walking or bicycling to work. It should be noted, however, that the overall percentages for 1990 are down slightly from the 1980 Census results, which showed 5.3 percent of persons commuting by walking and 1.4 percent by bicycling.

The 2002 National Survey of Pedestrian and Bicyclist Attitudes and Behaviors was sponsored by the USDOT NHTSA and Bureau of Transportation Statistics to gauge pedestrian and bicyclists trips, behaviors, and attitudes (see <http://www.bicyclinginfo.org/survey2002.htm>).⁽⁹⁾

According to the survey, approximately 57 million people, 27.3 percent of the population age 16 or older, rode a bicycle at least once during the summer of 2002. The survey breaks this down by gender, age, and race/ethnicity (see figure 2-3).

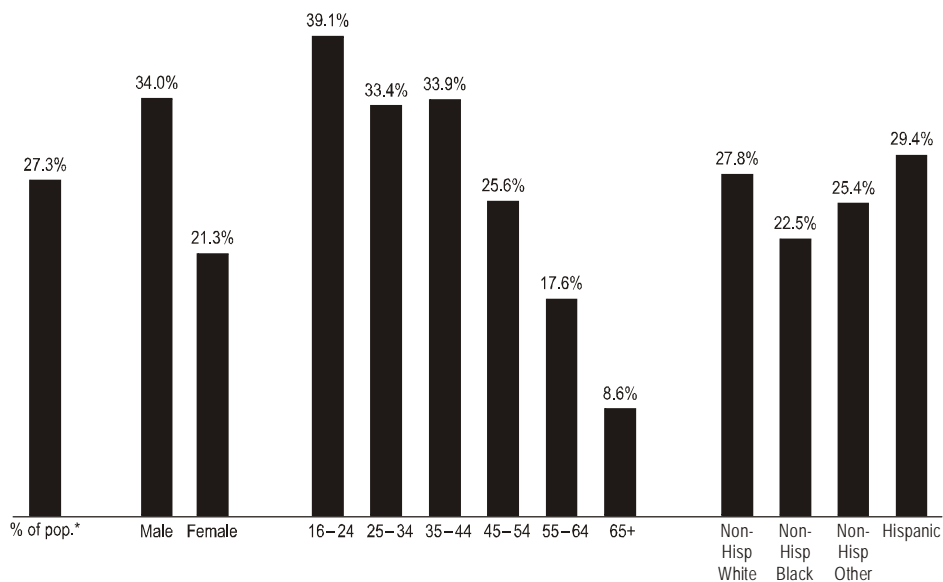

* Estimates reflect total U.S. population age 16 or older in the 50 state and the District of Columbia

Figure 2-3. Chart. Percentage bicycling in past 30 days by gender, age, race/ethnicity.

Source: 2002 National Survey of Pedestrian and Bicyclist Attitudes and Behaviors⁽⁹⁾

Comparisons between 1990 and 2000 Census data have provided some of the first evidence in the United States that higher levels of bicycle commuting result in areas where trails and on-road bicycle networks have been built. In Portland, OR and Washington, DC, local planners have used geographic information systems (GIS) to overlay the established trail networks with the 2000 census data to compare commute rates along census tracts that lie near trails and bikeways. In both cities, census tracts that lie adjacent to or near trails and bikeways exhibited levels of bicycle commuting that are higher than the local averages.

2.3 Factors Influencing the Decision to Bicycle or Walk

Many factors influence choice of travel mode and, in particular, the decision to bicycle or walk. These factors operate at different levels in the decision process. An analysis in the early 1990s identified a three-tiered hierarchy of factors categorized according to initial considerations, trip barriers, and destination barriers.⁽¹⁰⁾

Initial Considerations

Many people may never seriously consider the transportation options of bicycling and walking. Overcoming the status quo of automatically relying on a car to travel the 4.8 km (3 mi) to work or three blocks to the drugstore is an important first step in broadening the base of bicyclists and walkers. Activities such as Bike to Work days have been successfully employed in many communities to increase awareness of bicycling and walking as viable means of transport.

Either distance, or its companion factor, time, is often cited as a reason for not bicycling or walking. According to 2001 NHTS results, the average length of travel while shopping and taking other utilitarian trips are short. More importantly, nearly half of all travel trips are 4.8 km (3 mi) or less. All of these trips are within reasonable bicycling distance, if not within walking distance.

Individual attitudes and values are also important in the decision to bicycle or walk. People may choose not to bicycle or walk because they perceive these activities as uncool, as children's activities, or as socially inappropriate for those who can afford a car. Others may have quite different values, viewing bicycling and walking as beneficial to the environment, healthy, economical, and free from the problems of contending with traffic, or finding parking. These, and the many other benefits of bicycling and walking described previously, often influence people to begin bicycling and walking on a regular basis.

Individual perceptions (and misconceptions) also play a role in the decision process. Safety concerns such as traveling at night must be addressed. Although many bicycling and walking trips may be accomplished at low levels of exertion, some people perceive that these activities are beyond their capabilities.⁽¹¹⁾ While a small portion of the population may not have the physical capabilities to walk to a destination or ride a bicycle, for most people, these activities are well within their abilities. Also, as stamina and skill increase, such activities become easier and more enjoyable.

Finally, there are situational constraints that, while they may not totally preclude the decision to bicycle or walk, do require additional planning and effort. Examples include needing a car at work, having to transport items that are heavy or bulky, and needing to drop off children at daycare. While these situations may make it more difficult to bicycle or walk, they can often be overcome with advance planning. More analysis of these issues would be useful. If bicycling and walking are not appropriate for one particular trip, there are still a number of trips during the course of a day or week in which bicycling and walking are viable options.

Trip Barriers

Even with a favorable disposition toward bicycling and walking, reasonable trip distances, and absence of situational constraints, many factors can still encourage or discourage the decision to bicycle or walk. One of the most frequently cited reasons for not bicycling or walking is fear for safety in traffic.⁽¹¹⁾ Given the prevailing traffic conditions found in many urban and suburban areas—narrow travel lanes, high motor vehicle speeds, congestion, lack of sidewalks, pollution, etc.—many individuals who could meet their transportation needs by bicycling or walking do not, simply because they perceive too great a risk to their safety and health (see figure 2-4).



Figure 2-4. Photo. Street crossings can be a significant barrier to walking.

Perceptions of safety as well as actual safety problems must be addressed at the local level. Locational constraints such as lack of alternatives to high-speed, high motor vehicle volume roadways must be carefully handled. Adequate facilities can help overcome many of these safety concerns, whether they are sidewalks for walking, smooth shoulders, wide curb lanes, bicycle lanes, or off-road paths for the enjoyment of both bicyclists and walkers. Traffic calming measures are another way to enhance bicycle and pedestrian safety and accommodation.

Traffic safety can also be improved through education and law enforcement activities. Training opportunities that help bicyclists feel more competent riding in traffic, campaigns that remind motorists to share the road, and efforts to cite motorists who fail to yield to pedestrians at intersections are just a few examples.

Even communities with well-designed bicycling and walking facilities can still be plagued by problems with access and linkage. A beautifully designed and constructed off-road facility is useless to the bicyclist or pedestrian who cannot traverse a narrow bridge or cross a freeway to get to it. Similarly, facilities that do not connect neighborhoods to shopping areas or downtown businesses may never achieve their

intended purpose of increased use of nonmotorized travel modes. Directness of the route and personal safety and security considerations are also important factors in people's decisions to bicycle or walk.

Environmental factors could also be considered in this category of trip barriers. Examples include hilly terrain, extreme temperatures, high humidity, and frequent or heavy rainfall. Like many of the other trip barriers cited, these are to a great extent subjective and have been dealt with by those already engaging in these activities, many of whom have effectively overcome these difficulties. For potential users, these issues must be addressed and overcome if possible.

Destination Barriers

Facility and infrastructure needs do not stop with arrival at the work site or other destination. Many bicyclists are discouraged from becoming bicycle commuters because once at work they have no place to safely park their bicycle and no place where they can shower and change (although if the trip is made at lower levels of exertion, showering, and changing clothes may not be necessary).

Secure bicycle parking deserves special attention. The availability of parking is a prerequisite for automobile use; the same holds true for bicycling. Bicyclists are further burdened by the possibility of theft or damage to their bicycles. A Baltimore, MD, survey of bicyclists reported that 25 percent had suffered theft, with 20 percent of those giving up bicycling as a result. In New York City, bicycle theft numbers in the thousands annually. Even when parked securely, bicycles are frequently exposed to damage from rain and other environmental conditions. Secure parking areas for bicycles are necessary before bicycle use will increase.

Destination barriers can also take a less tangible form, such as a lack of support from employers and co-workers. Such support can be particularly important for sustaining a long-term commitment to bicycling or walking. In some cases, this support may be tangible, such as a discount on insurance costs or reimbursed parking expenses. In other cases, it may be less tangible, but equally important, such as allowing a less formal dress code or establishing a policy of flextime so that employees do not have to commute during the heaviest traffic times or in darkness.

To summarize, a variety of factors enter into the decision to walk or bike for utilitarian purposes. Some of these, such as trip distance, must be considered at the very outset of the decision and the process. It must be addressed if current levels of bicycling and walking are to be increased.⁽¹⁾

2.4 Potential for Increasing Bicycling and Walking

What is the potential for increasing bicycling and walking in the United States? Can the relatively high levels of bicycling and walking found in cities such as Davis, CA, and Madison, WI, be duplicated in other communities? Can U.S. cities approach the high usage levels found in some European and Asian cities?

Clearly, if aggregate levels of bicycling and walking are to be increased, changes must occur to remove the barriers previously discussed. This section identifies a variety of factors that impact the potential of bicycling and walking to become viable transportation modes in the United States.

Public Support for Bicycling and Walking

As mentioned in the previous chapter, the public already strongly supports increased travel options. The 1991 Harris Poll cited earlier showed that 46 percent of adults age 18 and older—82 million Americans—had ridden a bicycle in the previous year. Of these:

- Forty-six percent stated they would sometimes commute to work by bicycle if safe bicycle lanes were available.
- Fifty-three percent would do so if they had safe, separate designated paths on which to ride.
- Forty-five percent would do so if their workplace had showers, lockers, and secure bicycle storage.
- Forty-seven percent would do so if their employer offered financial or other incentives.⁽¹²⁾

Other Considerations

Other factors can also significantly impact the potential for bicycling and walking in the United States. Of particular relevance are: (1) the linkage of bicycle and pedestrian travel to transit, (2) the expansion of recreational bicycling and walking to more utilitarian uses, and (3) the potential impact of bicycle design technology.

The transit connection. The potential for bicyclist and pedestrian integration with transit is enormous. According to 2001 NHTS data, more than half of all people nationwide live less than 3.2 km (2 mi) from the closest public transportation route. The median length of an automobile trip to access a park-and-ride lot for public transit is less than 4.8 km (3 mi); and for a kiss-and-ride trip in which a passenger is dropped off, median trip length ranges from 2.1 to 2.6 km (1.3 to 1.6 mi).⁽¹³⁾

Since these short-distance, cold-start motor vehicle trips generate significant pollution, improved bicyclist and pedestrian access to transit can also reap environmental benefits. A 1980 Chicago area transportation study found bike-and-ride to be by far the most cost-effective means of reducing hydrocarbon emissions. The conversion of only 10 percent of park-and-ride commuters to bike-and-ride could result in gasoline savings of more than 2.2 million gallons annually.⁽¹³⁾

While much potential remains unrealized, the bicycle-transit link is gaining momentum:

- In Phoenix, AZ, the first major city to use bus bicycle racks system wide, there are an estimated 13,000 bicyclist boardings per month.
- In the first 3 months of the Portland, OR, Tri-Met program, more than 700 bicyclists bought permits to allow bicycles on buses and light rail.
- In California, surveys show that one-third to two-thirds of bicycle locker users at park-and-ride lots drove alone to their final destination before switching to bike-and-ride. In San Diego, the average bicyclist rides 5.8 km (3.6 mi) to access a locker prior to traveling another 17.7 (11.0 mi) by transit.

Recreational bicycling and walking. The popularity of bicycling and walking as both recreational activities and healthy forms of outdoor exercise is well documented. Over the past decade, both activities have enjoyed widespread and growing participation by the American public. The distinction between recreational bicycling and walking and utilitarian bicycling and walking is not always clear-cut. One approach is to classify a bicycle or walking trip as utilitarian only if it would otherwise have been made by an alternative mode of transport, such as a car or bus (the mode substitution test). By this definition, the age of the person and the nature of the facility on which the travel takes place do not enter into consideration. If a child rides a bicycle, even on the sidewalk, down the street to a friend's house, this is a legitimate transportation trip.

According to the Bicycle Federation of America (BFA), there are already an estimated 131 million recreational bicyclists and walkers. These people have demonstrated their ability to travel under their own power. They have also experienced firsthand the physical, psychological, and other benefits of bicycling and walking. This population will be instrumental in achieving the goal of doubling the percentage of utilitarian bicycling and walking.

The primary question that remains is how to convert more of these recreational bicyclists and walkers to persons using these modes for utilitarian travel. The 1991 Harris Poll suggests that at least part of the answer lies in improving existing facilities for bicycling and walking, building sidewalks and designated bicycle facilities, installing secure bicycle parking at destinations, etc.⁽¹¹⁾ Other surveys support this conclusion.⁽¹²⁾ However, it is uncertain to what extent a person's professed intention to bicycle or walk (if certain facilities are made available) will correspond to actual changes in their travel behavior, should these improvements be realized. Nevertheless, recreational bicyclists and walkers represent a strong candidate pool of potential bicycling and walking commuters.

Bicycle design technology. Another factor that may affect the potential for increased bicycling is the bicycle itself, along with the many accessories that accompany it. The resurgence of bicycling in the 1980s may be partially credited to the development of mountain bikes. Technological innovations and highly functional design have made this type of bicycle user-friendly and versatile for a wide range of people and uses. New bicycle designs, some of which are just now appearing and are appropriate for transit interface, short-distance cargo carrying, and easy use, further broaden ridership. Perhaps a more intelligent bicycle design can contribute to a significant increase in utilitarian bicycle trips.⁽¹⁾

2.5 Need for Action: Pedestrians and Bicyclists at Risk

An increasing percentage of the U.S. population is affected if pedestrians and bicyclists are not accommodated in transportation facilities and programs. Children, older adults, and people with disabilities make up a substantial portion of the population—up to 37 percent in some States. To maintain independence and mobility, these people walk and ride bicycles.

Age groups affected. More than other age groups, children and older adults (age 66+) rely on walking or bicycling as their primary transportation mode. They have few options in most cases. They must achieve mobility within the physical limitations associated with old age and with the early stages of children's physical development:

- Children have not yet acquired the skills needed for traffic safety. Their physical development in such things as peripheral vision and ability to discern the source of sounds is incomplete.
- Older adults have the experience and basic skills, but often move around more slowly than they used to, have poor eyesight, hearing loss, and a range of other disabilities. Walking helps older adults to retain some degree of independence in spite of their other disabilities.

Bicycle and pedestrian crashes. Children and older adults are highly overrepresented in bicycling and pedestrian crash statistics. Approximately 4,900 pedestrians and 700 bicyclists are killed each year as a result of collisions with motor vehicles. As a group, pedestrians and bicyclists comprise more than 14 percent of all highway fatalities each year. Pedestrians account for as much as 40 to 50 percent of traffic fatalities in some large urban areas.⁽¹³⁾

2.6 Student Exercises

The following are suggested ideas for student exercises.

Exercise A

List and describe several issues or limitations related to walking or cycling and how they can be overcome (e.g., land use, weather, facilities at the workplace, connectivity, etc.)

Exercise B

Search the county or city statistics on factors that effect bicycle and pedestrian usage (e.g., number of miles of bike facilities or sidewalks, connectivity, access by car, portage on transit).

Exercise C

Gather statistics on mode share for the county or city, and document the general planning and design for the network system. Is it a grid system, and how connected are transit, bike, and pedestrian systems, etc.?

Exercise D

Write an essay on how you would get around your city or town if you had only a defined amount of gasoline, which might vary depending on location. Keep a diary for a week, indicating method of travel for each type of trip, mode taken, trip distance, duration, and other important details.

2.7 References and Additional Resources

The references for this lesson are:

1. *National Bicycling and Walking Study*, FHWA, Publication No. FHWA-RD-94-023, Washington, DC, 1994, available online at <http://www.fhwa.dot.gov/environment/bikeped>.
2. Image Library, PBIC, available online at <http://www.pedbikeimages.org>, accessed May 6, 2004.
3. *Travel Forecast Summary*, Travel Industry Association of America, Bureau of Labor and Statistics, Department of Labor, Bureau of Economic Analysis, Department of Commerce, Washington, DC, 2003, available online at <http://www.tia.org/Travel/forecasts.asp>.
4. *Sports Participation in 2003*, National Sporting Goods Association, Mt. Prospect, IL, 2003, available online at <http://www.nsga.org>.
5. *Highlights of the 2001 NHTS*, USDOT, Bureau of Transportation Statistics, Washington, DC, 2003.
6. 1995 Nationwide Personal Transportation Survey, available online at <http://npts.ornl.gov/npts/1995/doc/index.shtml>, accessed August 12, 2005.
7. Pucher, J. and J.L. Renne, "Socioeconomics of Urban Travel: Evidence from the 2001 NHTS," *Transportation Quarterly*, vol. 57, no. 3, summer 2003, pp. 49–77, available online at <http://www.vtpi.org/TQNHTS.pdf>.

8. *Journey to Work 2000: Census 2000 Brief*, U.S. Department of Commerce, U.S. Census Bureau, Washington, DC, March 2004, available online at <http://www.census.gov/prod/2004pubs/c2kbr-33.pdf>.
9. *2002 National Survey of Pedestrian and Bicyclist Attitudes and Behaviors: Highlights Report*, NHTSA and Bureau of Transportation Statistics, Washington, DC, 2003, available online at <http://www.bicyclinginfo.org/survey2002.htm>, accessed May 3, 2004.
10. *The National Bicycling and Walking Study Case Study No. 1: Reasons Why Bicycling and Walking Are Not Being Used More Extensively as Travel Modes*, FHWA, Publication No. FHWA-PD-92-041, Washington, DC, 1992.
11. *The National Bicycling and Walking Study Case Study No. 4: Measures to Overcome Impediments to Bicycling and Walking*, FHWA, Publication No. FHWA-PD-93-031, Washington, DC, August 1993.
12. *Pathways for People*, Rodale Press, Inc., Emmaus, PA, June 1992.
13. *The National Bicycling and Walking Study Case Study No. 9: Linking Bicycle/Pedestrian Facilities with Transit*, FHWA, Publication No. FHWA-PD-93-012, Washington, DC, October 1992.

Additional resources for this lesson include:

- *Pedestrian and Bicyclist Safety and Accommodation Course Participant Workbook*, FHWA, Publication No. FHWA-HI-96-028, Washington, DC, 1996.
- Robinson, F., J. Edwards, and C. Ohrn, "Strategies for Increasing Levels of Walking and Bicycling for Utilitarian Purposes," *Transportation Research Record 743*, TRB, Washington, DC, 1980.
- *The National Bicycling and Walking Study Case Study No. 16: A Study of Bicycle and Pedestrian Programs in European Countries*, FHWA, Publication No. FHWA-PD-92-037, Washington, DC, January 1992.

LESSON 3:

PEDESTRIAN AND BICYCLIST SAFETY

3.1 Introduction

Many professionals involved in pedestrian and bicycle programs have never received training that focuses on crash causation. Everyone—from traffic safety specialists to traffic engineers, planners, educators, and law enforcement personnel—can benefit from an understanding of how crashes occur and how to avoid them. It should be noted, however, that in some cases, the study of bicycle and pedestrian conflicts with vehicles may be more useful than crash analyses. Conflict analysis may be useful because bicycle and pedestrian crashes may be a rare occurrence on some facilities and may not be the best measure of operational analysis.

This lesson provides an understanding of crash characteristics, crash rates, exposure, crash typing, crash analysis, benefit-cost analysis, and associated countermeasures. The most significant crash types will be explained and associated with contributing factors and typical errors made. The concepts of corridor and site crash analysis and team problem solving will be emphasized. Discussion will include special conditions—especially nighttime crashes, those involving impaired drivers, pedestrians and bicyclists, and high-speed roadways. The major sections of the lesson are as follows:

- 3.1 Introduction
- 3.2 What Is a Crash?
- 3.3 The Crash Avoidance Process
- 3.4 Number of Bicycle and Pedestrian Crashes
- 3.5 Summary of Bicycle and Pedestrian Crash Characteristics
- 3.6 Common Pedestrian and Bicycle Crash Types
- 3.7 Pedestrian and Bicycle Crash Analysis Tool (PBCAT)
- 3.8 Bike and Pedestrian Countermeasures.
- 3.9 Bike and Pedestrian Safety Goals
- 3.10 Geographic Information System (GIS) Crash Frequency Analysis
- 3.11 Benefit-Cost Analysis
- 3.12 Student Exercise
- 3.13 References and Additional Resources

3.2 What Is a Crash?

The word “crash” may be new to some people as a way to describe the event in which a bicyclist or pedestrian collides with the ground, a motor vehicle, or any other solid object in a way that can result in bodily harm and/or property damage. Historically, these events were called accidents. The term accident implies heavy doses of chance, unknown causes, and the connotation that nothing can be done to prevent them.

Crashes are preventable. Bicyclist and pedestrian crashes are not random events. They fall into a pattern of recurring crash types and occur because the parties involved make mistakes. The mistakes can be

identified and counteracted through a combination of education, skill development, engineering, and enforcement measures that can substantially reduce crash occurrences.

3.3 The Crash Avoidance Process

Whether you are a pedestrian, bicyclist, or motorist, you generally go through a similar sequence of actions leading from searching for and recognizing a potential crash situation to taking steps to avoid it. The steps in this sequence are described below. If either party overlooks any of these steps, a crash may result.

- Step 1: Search—Both driver and bicyclist or pedestrian scan their environment for potential hazards (see figure 3-1).
- Step 2: Detect—One or both parties (bicyclist, pedestrian, or motor vehicle) see the other.
- Step 3: Evaluate—The threat of collision is recognized, along with the need for action to avoid it.
- Step 4: Decide—Assess risk and select the actions necessary to avoid a collision. This may involve judging location, closing speed, direction of travel, position in traffic, likely behavior, and other factors.
- Step 5: Action—This step involves the successful performance of the appropriate action(s) to avoid a collision.

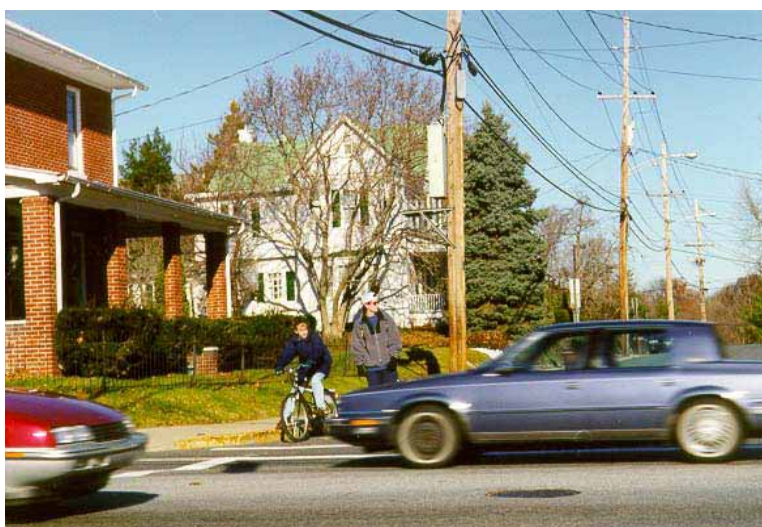

(This picture shows a bicyclist not wearing a helmet. FHWA strongly recommends that all bicyclists wear helmets.)

Figure 3-1. Photo. Bicyclist scanning for potential hazards.

3.4 Number of Bicycle and Pedestrian Crashes

According to statistics from NHTSA, approximately 4,749 pedestrians and 622 bicyclists were killed in 2003 as a result of collisions with motor vehicles (see figure 3-2).^(1,2) As a group, pedestrians and bicyclists comprise about 13 percent of all highway fatalities each year. There were more than 70,000 pedestrian injuries and 46,000 bicyclist injuries reported as well in 2003 (see figure 3-3).

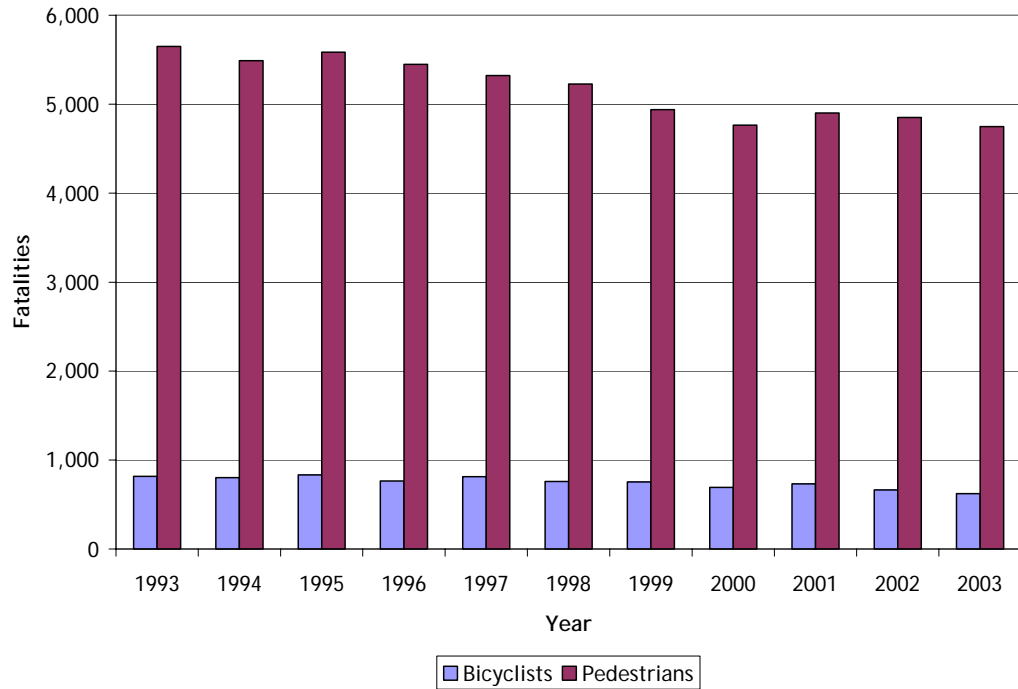

Figure 3-2. Graph. Trends in pedestrian and bicyclist fatalities.

Source: NHTSA Traffic Safety Facts 2003^(1,2)

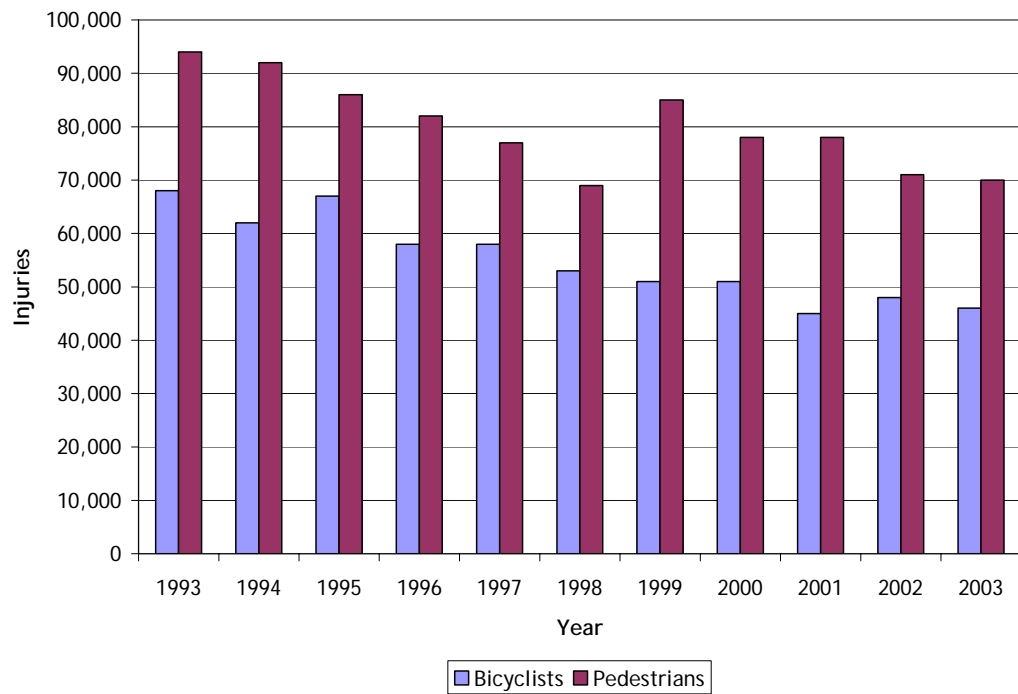

Figure 3-3. Graph. Trends in pedestrian and bicyclist injuries.

Source: NHTSA Traffic Safety Facts 2003^(1,2)

The reported injuries are subject to significant undercounting; many more injuries were not reported to record-keeping authorities. A study by Hunter, et al., indicates that less than two-thirds of bicycle-motor vehicle crashes serious enough to require emergency room treatment were reported on State motor vehicle crash files.⁽³⁾ Another study of emergency room records confirmed that there are numerous pedestrian and bicycle injuries that are never recorded by transportation authorities.⁽⁴⁾ This may be due, in part, to the fact that the crashes didn't involve a motor vehicle (70 percent of reported bike injuries and 64 percent of pedestrian injuries) or that they occurred at nonroadway locations such as sidewalks, parking lots, or off-road trails (31 percent of bike injuries and 53 percent of pedestrian injuries). However, these crashes should not be overlooked or dismissed, as they still may have been caused by poor roadway facilities that could be improved by engineering or planning methods.

The number of pedestrian fatalities has dropped 16 percent from the 5,649 pedestrians killed in 1993, showing a steady decline in pedestrian-motorist crashes each year (see figure 3-2). The number of bicyclists killed in 2003 was 24 percent lower than the 816 fatalities reported in 1993. From 1993 to 2003, bicyclist fatalities per year have fluctuated, but they have not risen higher than the number reported in 1993 (see figure 3-2).

Of all nonmotorist traffic fatalities recorded in 2001, 85 percent were pedestrians, 13 percent were bicyclists, and the remaining 2 percent were inline skaters, skateboard riders, etc.

3.5 Summary of Bicycle and Pedestrian Crash Characteristics

Bicycle-Motor Vehicle Crashes

NHTSA provided the following statistics from 2003 that describe bicycle-motor vehicle crashes.⁽¹⁾

Age

Sixty-two percent of bicyclists killed and 84 percent of those injured were between 5 and 44 years of age. In 2003, the average age of those killed was 35.8 years; the average age of those injured was 26.5 years. The proportion of bicyclists 25 years of age and older killed in motor vehicle crashes has risen since 1993. In 1993, 25 to 64-year-olds made up 41 percent of all bicyclist fatalities, while in 2001, that age group made up 57 percent.

At the same time, the proportion of bicyclists under age 16 involved in fatal crashes has declined since 1993. In 1993, young bicyclists (16 and younger) accounted for 38 percent of all bicyclists killed. In 2003, they accounted for 23 percent of all bicyclists killed and 37 percent of those injured. Twenty-three percent of the bicyclists killed in 2003 were between 5 and 15 years of age.

Gender

Most of the bicyclists involved in motor vehicle crashes in 2003 were males—88 percent of those killed and 78 percent of those injured. The male bicyclist fatality rate was almost eight times as high as the female rate, and the male injury rate was more than three times higher than the rate of injury for females.

Drug Impairment

Alcohol involvement, with either the driver or bicyclist, was reported in more than 33 percent of the fatal bicyclist crashes in 2003. In 32 percent of the fatal incidents, either the driver or the bicyclist was considered legally intoxicated (blood alcohol concentration of 0.08 grams per deciliter or greater). Lower alcohol levels were reported in an additional 7 percent of fatal bicycle-motor vehicle crashes. More than

one-fourth of the bicyclists killed were intoxicated. This may be an emerging problem. Alcohol-drug crashes were more frequent on weekends and during hours of darkness.

Time of Day and Year

Almost one-third (31 percent) of the fatal bicyclist crashes occurred during late afternoon and early evening hours between 5 p.m. and 9 p.m. Bicyclist and pedestrian activity (i.e., exposure) is likely quite high during these hours, and visibility can be a problem. Thirty-five percent of all bicyclist fatalities occurred during the months of June, July, and August, months when bicycle riding peaks and exposure is high.

Location

About 69 percent of the fatal bicyclist crashes were categorized as urban, and 71 percent of the fatal crashes occurred at nonintersection locations. However, for nonfatal crashes, more collisions occurred at roadway intersections than nonintersection locations. Roads with narrower lanes, no shoulders, and higher speed limits were associated with more than their share of serious and fatal injuries to bicyclists.

Factors Contributing to Bicycle-Motor Vehicle Crashes

The 1996 FHWA investigation studied 3,000 bicycle crashes in 5 States to determine factors contributing to the crashes.⁽³⁾ Bicyclists were judged to be at fault in about half of these crashes with motor vehicles. Failure to yield, riding against traffic, stop sign violations, and safe movement violations were the bicyclist factors most frequently cited as contributing to crashes. Bicyclists need training about how to ride in traffic. The likelihood of the bicyclist being responsible for the crash was greatest for younger bicyclists. When the bicyclist involved in the crash was older, the motor vehicle driver was more likely to be at fault.

Motor vehicle drivers were judged to be solely at fault in 28 percent of the cases. Failure to yield, hit-and-run, and failure to see bicyclists were the driver factors most frequently cited as contributing to crashes.

Pedestrian-Motor Vehicle Crashes

NHTSA provided the following statistics that characterize pedestrian crashes:⁽²⁾

Age

Compared to their representation in the overall U.S. population, young persons (under 25 years of age) were overrepresented in pedestrian crashes with motor vehicles, whereas older adults (ages 50 to 69) and the elderly (age 70+) were underrepresented. However, elderly pedestrians who were involved in crashes were more likely to be killed. Older pedestrians (ages 70+) accounted for only 6 percent of pedestrians injured but 16 percent of pedestrians killed. Pedestrians aged 0 to 16, on the other hand, accounted for 27 percent of all pedestrians injured in 2003, but only 9 percent of those killed.

Gender

Sixty-nine percent of the pedestrian fatalities that occurred in 2003 were males. The male pedestrian fatality rate was more than double (2.27) the female pedestrian fatality rate; the pedestrian injury rate was considerably higher for males than females as well.

Drug Impairment

Alcohol is often a key factor in pedestrian-motor vehicle crashes that lead to fatalities. In 2003, 46 percent of the traffic crashes that resulted in pedestrian fatalities involved alcohol intoxication by either the driver or the pedestrian. Thirty-four percent of the total number of pedestrians involved in fatal crashes were considered legally intoxicated, while 13 percent of the drivers involved were intoxicated. Six percent of the fatal crashes involved both an intoxicated driver and pedestrian.

Time of Day and Week

Pedestrian crashes occurred most frequently during the late afternoon and early evening hours, times when exposure is probably highest and visibility may be a problem. Forty-four percent of the pedestrian fatalities under 16 years of age occurred between 3 p.m. and 7 p.m. Sixty-five percent of all pedestrian incidents occurred at night. Fatality counts also rose on weekends as well, with nearly one-half of all pedestrian fatalities occurring on a Friday, Saturday, or Sunday.

Location

About 72 percent of the crashes were categorized as urban. The elderly were overrepresented in commercial parking lot crashes, young adults in noncommercial parking lot crashes, and children under age 10 in collisions occurring in driveways, alleys, or yards.

Seventy-nine percent of the fatal pedestrian-motor vehicle crashes occurred at nonintersection locations. However, for nonfatal collisions, the percentage at nonintersection locations was significantly lowered, and more crashes occurred at roadway intersections. Serious and fatal injuries to pedestrians were directly proportional to speed limit and number of lanes.

Factors Contributing to Pedestrian-Motor Vehicle Crashes

In a 1996 study conducted by the FHWA, 5,000 pedestrian crashes in 5 States were studied extensively in order to determine contributing factors associated with the crashes.⁽³⁾ The report judged that pedestrians were solely at fault in 43 percent of the crashes. Running into the road, failure to yield, alcohol impairment, stepping out from between parked vehicles, and walking or running in the wrong direction (with traffic) were the pedestrian factors most frequently cited as contributing to crashes. Younger pedestrians were more likely to be at fault.

Motor vehicle drivers were judged to be solely at fault in 35 percent of the crashes. Driver hit-and-run and failure to yield were the driver factors most frequently cited as contributing to crashes, followed by improper backing, safe movement violations, and exceeding safe speed. Only 3 percent of motor vehicle drivers striking pedestrians were judged to have been impaired by alcohol in the 1996 study.

3.6 Common Pedestrian and Bicycle Crash Types

This portion of the lesson presents information specific to the types and characteristics of pedestrian and bicycle crashes. The information on crash types was generated from a 1996 FHWA study and a study conducted by the Highway Safety Research Center (HSRC) at the University of North Carolina.^(3,5,6) In the FHWA study, 8,000 pedestrian and bicycle crashes in 5 States were studied extensively in order to code crash types, determine the specific factors associated with the crash types, and identify how countermeasures could be used to reduce the frequency of crashes. The purpose of the HSRC study was to update 1970s era crash data to reflect more recent crash types, paying particular attention to roadway and

locational factors so that designers can reduce crash frequency through engineering methods and other interventions.

Pedestrian Crash Types

The FHWA study concluded that more than three-fourths of pedestrian crashes fell into one of the following eight crash-type categories (see table 3-1):⁽³⁾

Table 3-1. Pedestrian crash types.

Crash-Type Category	Percent of Total Pedestrian Crashes
Midblock Dart/Dash	13.3
Other Midblock	13.2
Other Intersection	10.1
Vehicle Turn/Merge	9.8
Not in Roadway/Waiting to Cross	8.6
Walking Along Roadway	7.9
Intersection Dash	7.2
Backing Vehicle	6.9
Total	77.0

Source: Pedestrian and Bicycle Crash Types of the Early 1990's⁽³⁾

These major crash-type categories varied with respect to the pedestrian, driver, location/environmental, and roadway factors that characterized them. It is critically important for individual States and communities to develop a better understanding of the particular traffic situations endangering their residents. Figures 3-4 through 3-11 display the eight most common pedestrian crash types.

Bicycle Crash Types

The FHWA study divided the bicycle-motor vehicle crashes into three general categories (see table 3-2):⁽³⁾

Table 3-2. Bicycle crash types.

General Crash-Type Category	Percent of Total Bicycle Crashes
Crossing-Path Events	57
Parallel-Path Events	36
Specific Circumstances	7
Total	100

Source: Pedestrian and Bicycle Crash Types of the Early 1990's⁽³⁾

The most frequent parallel-path crashes were motorist turn/merge into bicyclist's path (12.2 percent), motorist overtaking the bicyclist (8.6 percent), and bicyclist turn/merge into motorist's path (7.3 percent). The most frequent crossing-path crashes were caused by motorist failure to yield to bicyclist (21.7 percent), bicyclist failure to yield at an intersection (16.8 percent), and bicyclist failure to yield midblock (11.8 percent). These six individual crash types accounted for almost 80 percent of all bicycle-motor vehicle crashes. Figures 3-12 through 3-19 show the eight most common bicycle crash types.

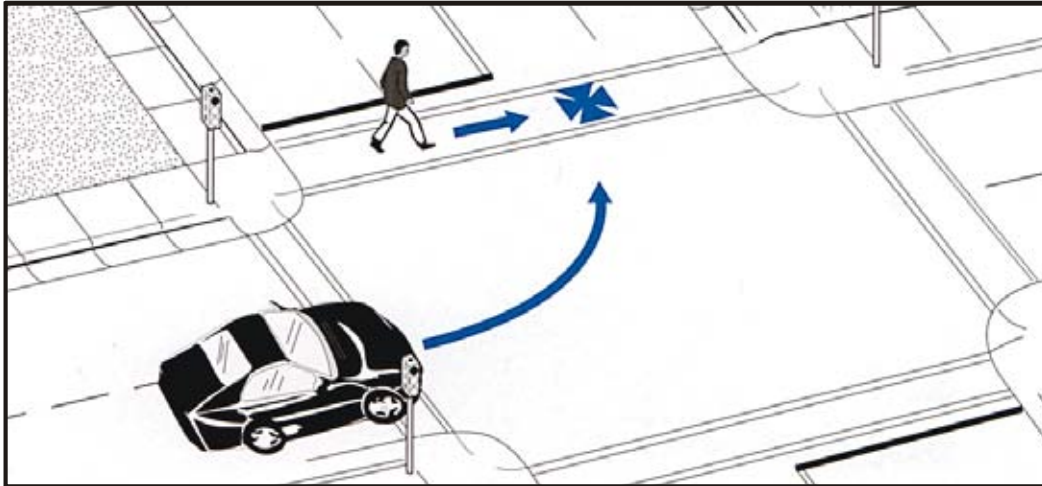

Frequency: 497 cases; 9.8% of all crashes
Severity: 18% resulted in serious or fatal injuries

Description: The pedestrian and vehicle collided while the vehicle was preparing to turn, in the process of turning, or had just completed a turn (or merge).

Figure 3-4. Illustration. Vehicle turn/merge.

Source: Pedestrian Crash Types: A 1990's Informational Guide⁽⁵⁾

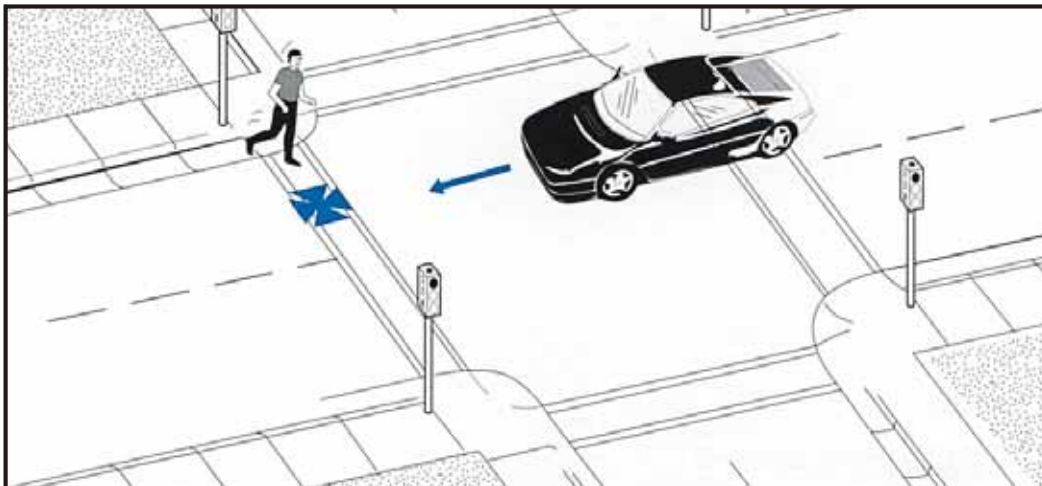

Frequency: 363 cases; 7.2% of all crashes
Severity: 34% resulted in serious or fatal injuries

Description: The pedestrian was struck while running through an intersection and/or the motorist's view of the pedestrian was blocked before impact.

Figure 3-5. Illustration. Intersection dash.

Source: Pedestrian Crash Types: A 1990's Informational Guide⁽⁵⁾

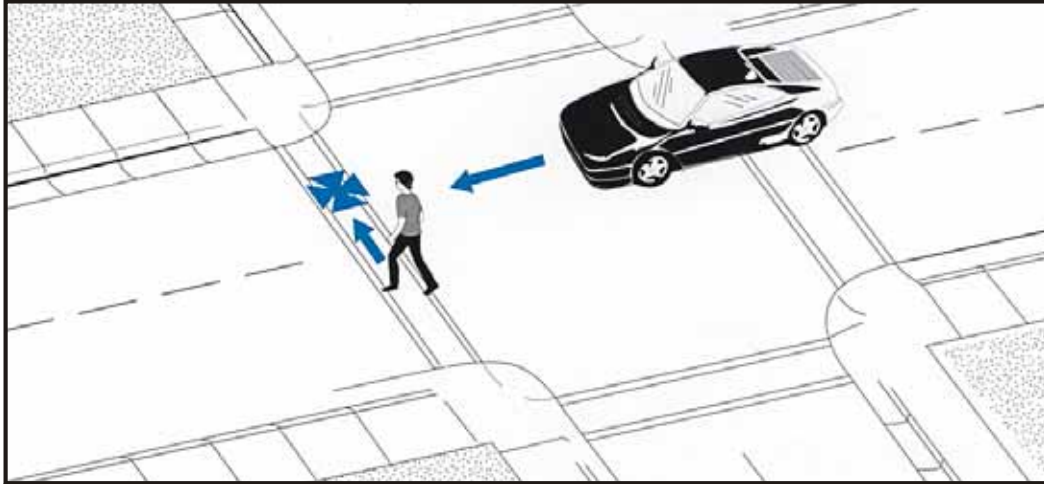

Frequency: 364 cases; 7.2% of all crashes
Severity: 42% resulted in serious or fatal injuries

Description: The crash occurred at an intersection but does not conform to any of the specific crash types.

Figure 3-6. Illustration. Other intersection.

Source: Pedestrian Crash Types: A 1990's Informational Guide⁽⁵⁾

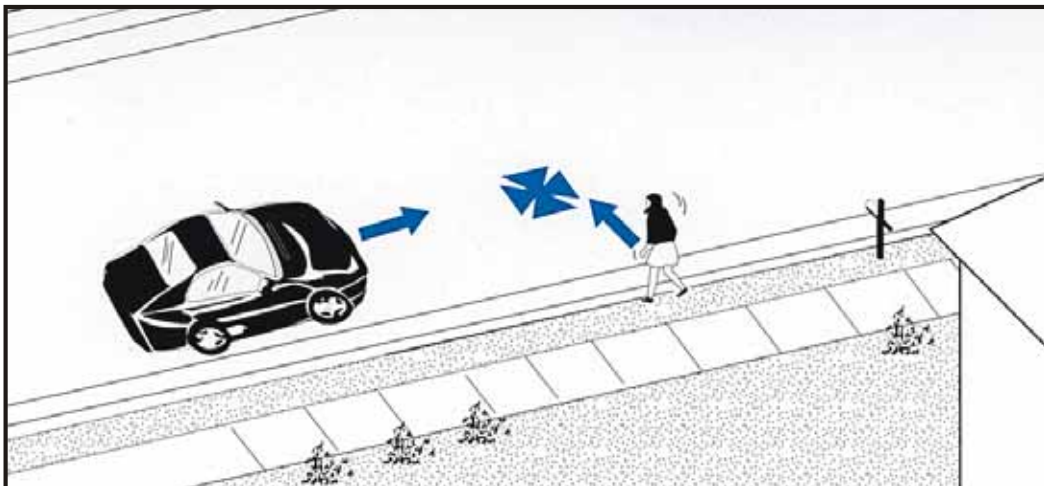

Frequency: 442 cases; 8.7% of all crashes
Severity: 37% resulted in serious or fatal injuries

Description: At midblock location, the pedestrian was struck while running and the motorist view of the pedestrian was not obstructed.

Figure 3-7. Illustration. Midblock dart/dash.

Source: Pedestrian Crash Types: A 1990's Informational Guide⁽⁵⁾

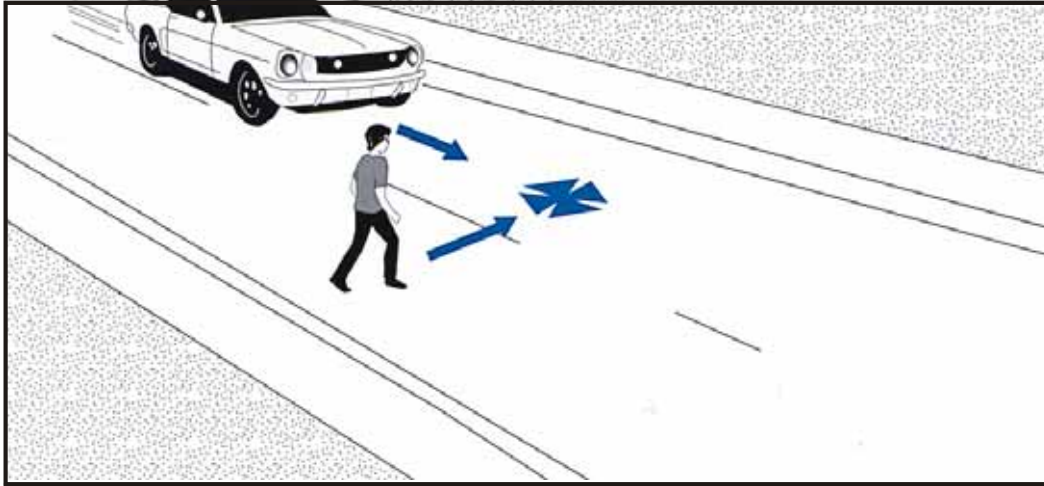

Frequency: 548 cases; 10.8% of all crashes
Severity: 49% resulted in serious or fatal injuries

Description: The crash occurred at midblock, but does not conform to any of the specific crash types.

Figure 3-8. Illustration. Other midblock.

Source: Pedestrian Crash Types: A 1990's Informational Guide⁽⁵⁾

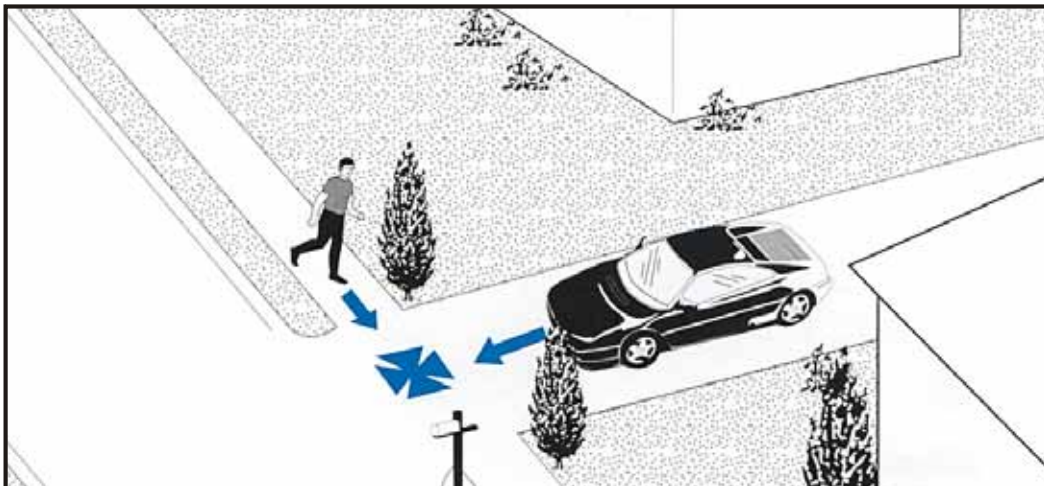

Frequency: 404 cases; 7.9% of all crashes
Severity: 28% resulted in serious or fatal injuries

Description: The pedestrian was struck when not in the roadway. Areas including parking lots, driveways, private roads, sidewalks, service stations, yards, etc.

Figure 3-9. Illustration. Not in roadway/waiting to cross.

Source: Pedestrian Crash Types: A 1990's Informational Guide⁽⁵⁾

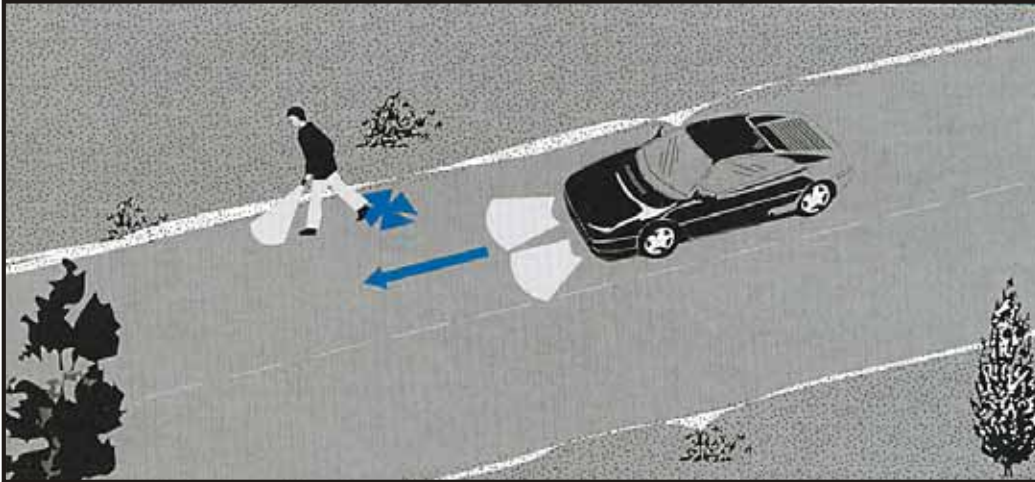

Frequency: 375 cases; 7.4% of all crashes

Severity: 37% resulted in serious or fatal injuries

Description: The pedestrian was struck while walking/running along a road without sidewalks. The pedestrian may have been: hitchhiking (15 cases), walking with traffic and struck from behind (257 cases) or from the front (5 cases), walking against traffic and struck from behind (76 cases) or from the front (7 cases), walking along a road, but the details are unknown (15 cases).

Figure 3-10. Illustration. Walking along roadway.

Source: Pedestrian Crash Types: A 1990's Informational Guide⁽⁵⁾

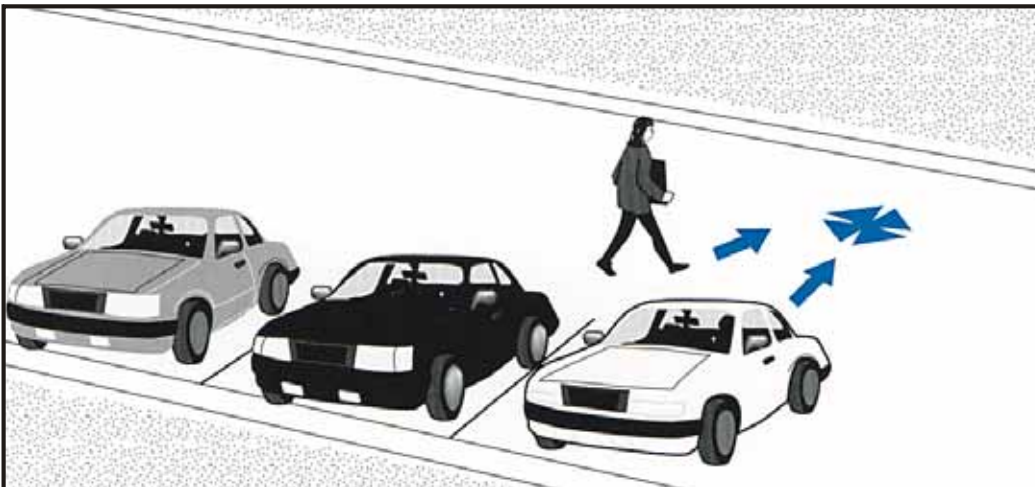

Frequency: 351 cases; 6.9% of all crashes

Severity: 23% resulted in serious or fatal injuries

Description: The pedestrian was struck by a vehicle that was backing.

Figure 3-11. Illustration. Backing vehicle.

Source: Pedestrian Crash Types: A 1990's Informational Guide⁽⁵⁾

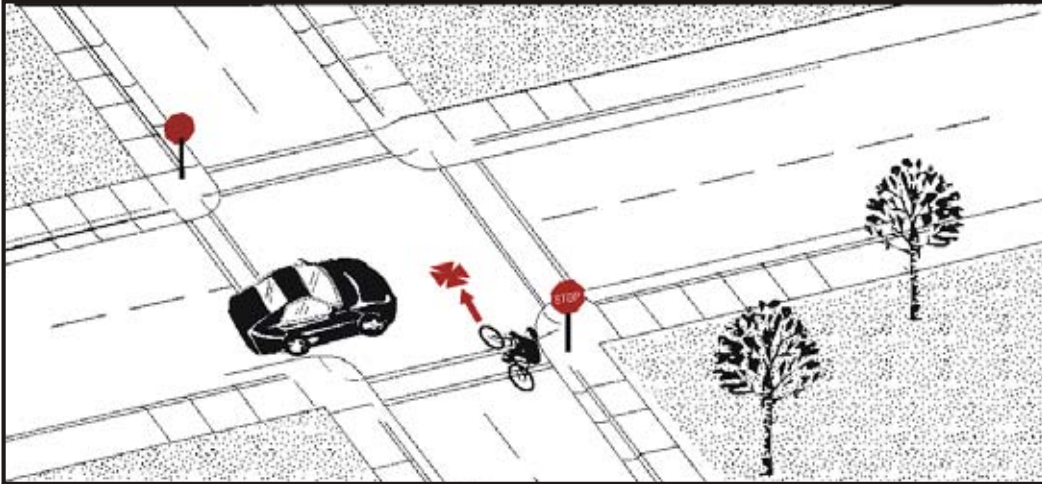

Frequency: 290 cases; 9.7% of all crashes
Severity: 23% resulted in serious or fatal injuries

Description: The crash occurred at an intersection at which the bicyclist was facing a stop sign or flashing red light.

Figure 3-12. Illustration. Ride out at stop sign.

Source: Bicycle Crash Types: A 1990's Informational Guide⁽⁶⁾

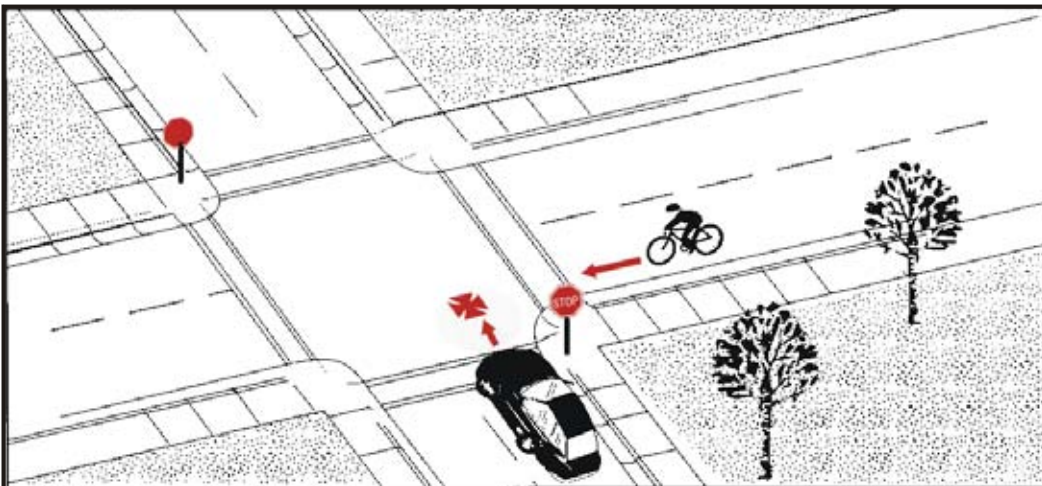

Frequency: 277 cases; 9.3% of all crashes
Severity: 10% resulted in serious or fatal injuries

Description: The crash occurred at an intersection at which the motorist was facing a stop sign.

Figure 3-13. Illustration. Drive out at stop sign.

Source: Bicycle Crash Types: A 1990's Informational Guide⁽⁶⁾

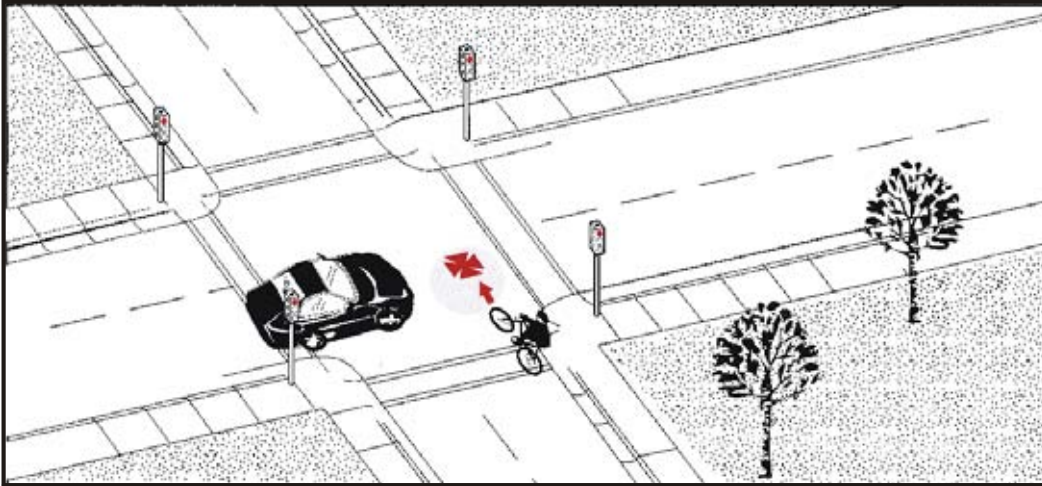

Frequency: 211 cases; 7.1% of all crashes
Severity: 16% resulted in serious or fatal injuries

Description: The crash occurred at an intersection (signalized or uncontrolled) at which the bicyclist failed to yield.

Figure 3-14. Illustration. Other ride out at intersection.

Source: Bicycle Crash Types: A 1990's Informational Guide⁽⁶⁾

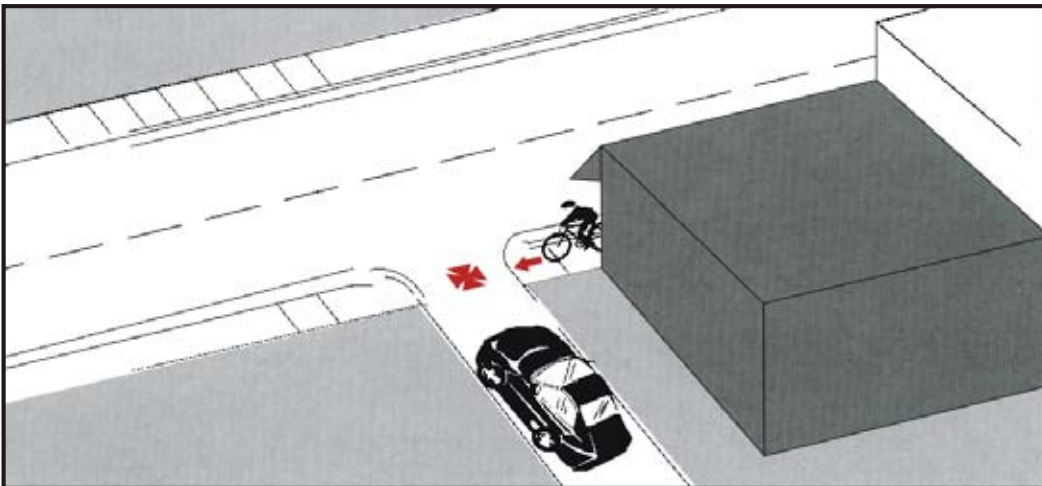

Frequency: 207 cases; 6.9% of all crashes
Severity: 7% resulted in serious or fatal injuries

Description: The motorist was entering the roadway from a driveway or alley.

Figure 3-15. Illustration. Drive out at midblock.

Source: Bicycle Crash Types: A 1990's Informational Guide⁽⁶⁾

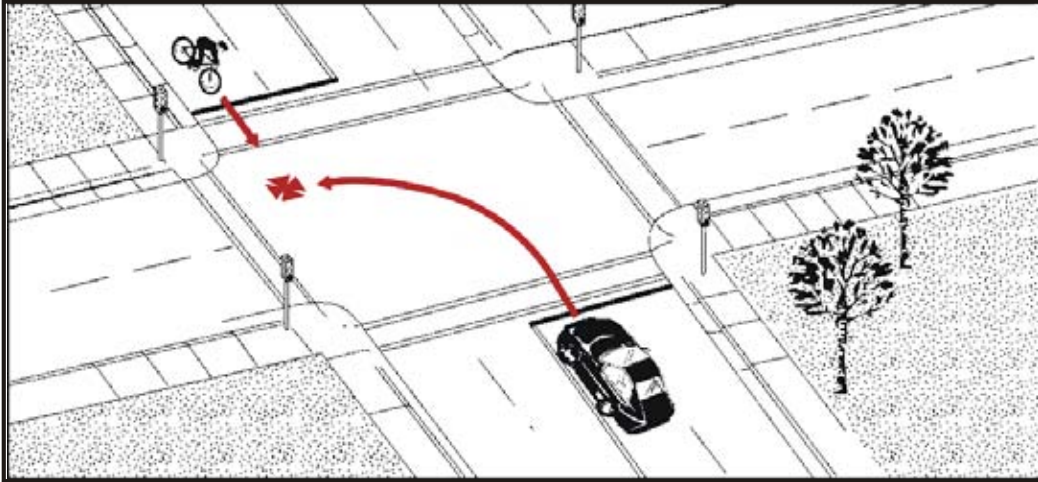

Frequency: 176 cases; 5.9% of all crashes
Severity: 24% resulted in serious or fatal injuries

Description: The motorist made a left turn while facing the approaching bicyclist.

Figure 3-16. Illustration. Motorist left turn, facing bicyclist.

Source: Bicycle Crash Types: A 1990's Informational Guide⁽⁶⁾

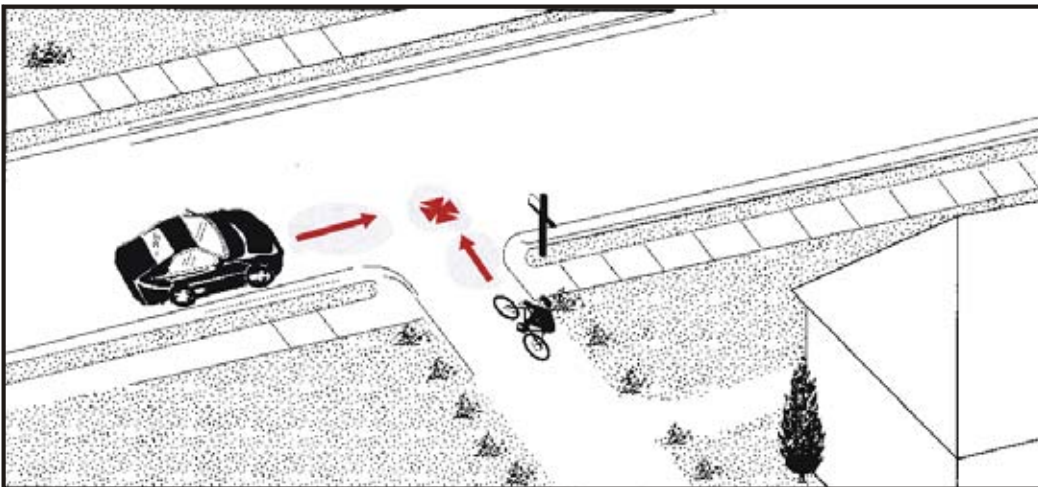

Frequency: 153 cases; 5.1% of all crashes
Severity: 24% resulted in serious or fatal injuries

Description: The bicyclist entered the roadway from a driveway or alley.

Figure 3-17. Illustration. Ride out at residential driveway.

Source: Bicycle Crash Types: A 1990's Informational Guide⁽⁶⁾

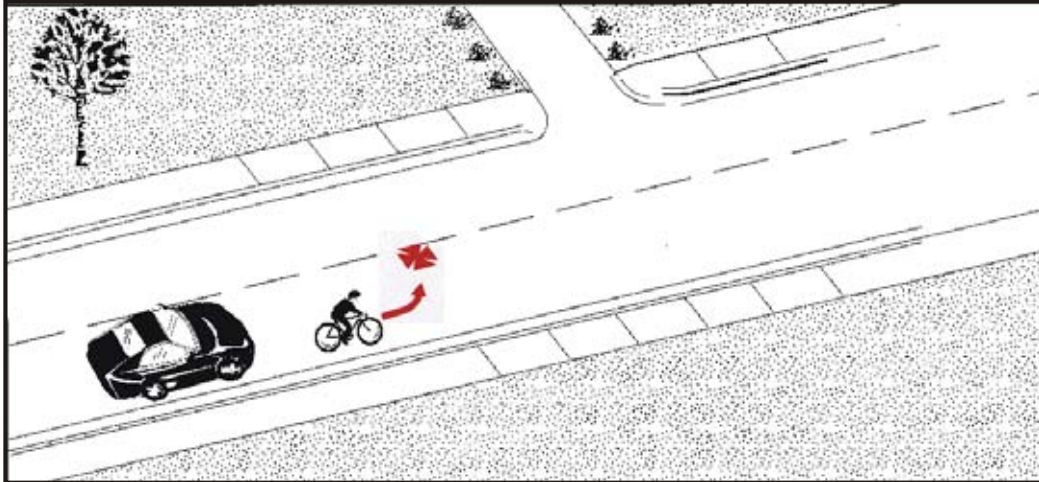

Frequency: 130 cases; 4.3% of all crashes
Severity: 28% resulted in serious or fatal injuries

Description: The bicyclist made a left turn in front of traffic traveling in the same direction.

Figure 3-18. Illustration. Bicyclist left turn in front of traffic.

Source: Bicycle Crash Types: A 1990's Informational Guide⁽⁶⁾

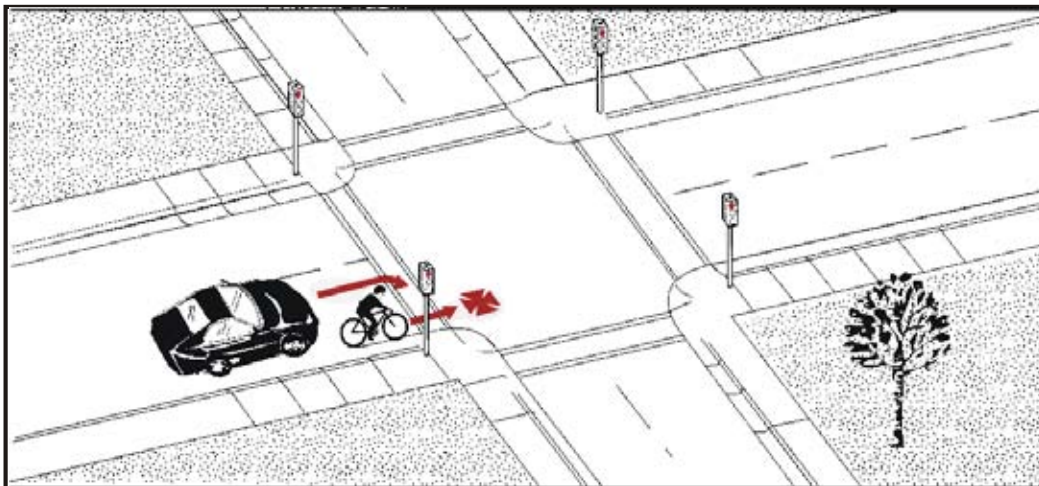

Frequency: 143 cases; 4.7% of all crashes
Severity: 11% resulted in serious or fatal injuries

Description: The motorist was making a right turn and the bicyclist was riding in either the same or opposing direction.

Figure 3-19. Illustration. Motorist right turn.

Source: Bicycle Crash Types: A 1990's Informational Guide⁽⁶⁾

3.7 Pedestrian and Bicycle Crash Analysis Tool (PBCAT)

FHWA, in cooperation with NHTSA, developed a Pedestrian and Bicycle Crash Analysis Tool (PBCAT) through the University of North Carolina HSRC. PBCAT is a user-friendly analysis tool that determines the crash type through a series of onscreen questions about the crash. It provides tabular and graphing functions of various factors (such as age, sex, light conditions, etc.) associated with the crash. The system also recommends countermeasures and related resources and reference information.

3.8 Bicycle and Pedestrian Countermeasures

Sections 3.6 and 3.7 discussed common crash types and how to determine these crash types by using PBCAT. This section provides a list of countermeasures that might be employed to offset a specific pedestrian crash type (see figure 3-20). Table 3-3 lists more than the general crash types previously provided and was adapted from the *Pedestrian Facilities Users Guide*.⁽⁷⁾ Bike countermeasures may overlap with some pedestrian countermeasures. An exhaustive list of bike countermeasures can be found in the FHWA Bicycle Safety Tools and Technology page located on the FHWA Safety Web site. There, roadway countermeasures are listed for numerous types of bicyclist and motorist errors; these are organized by the type of entity that could implement the change.



Figure 3-20. Photo. A crosswalk can increase the visibility of a pedestrian path.

Source: PBIC Image Library, <http://www.pedbikeimages.org>⁽⁸⁾

Table 3-3. Crash types and associated countermeasures.

Source: Pedestrian Facilities Users Guide⁽⁷⁾

Countermeasure	Midblock Dart/-Dash	Multiple Threat	Midblock Mailbox, etc.	Failure to Yield (Unsignalized)	Bus-Related	Turning Vehicle at an Intersection	Through Vehicle at Intersection	Walking Along Roadway	Working/Playing in Roadway	Not in Road	Backing Vehicle	Crossing Expressway
1. Sidewalk/Walkway					•			•	•	•	•	
2. Curb Ramp				•	•	•	•	•				
3. Crosswalk Enhancements	•	•		•	•	•	•					
4. Transit Stop Treatments	•	•		•	•	•	•					
5. Roadway Lighting	•	•	•	•	•	•	•	•	•	•	•	•
6. Overpass/Underpass	•	•		•		•	•					•
7. Street Furniture	•				•			•				
8. Bike Lane/Shoulder	•	•	•	•	•			•	•	•		
9. Road/Lane Narrowing	•	•	•	•				•	•			
10. Fewer Lanes		•		•	•			•				
11. Driveway Improvements										•	•	
12. Raised Median	•	•	•	•		•	•					
13. One-Way Street						•	•					
14. Smaller Curb Radius				•		•				•		
15. Right-Turn Slip Lane						•						
16. Modern Roundabout						•	•					
17. Modified T Intersection						•						
18. Intersection Median Barrier		•		•		•	•					
19. Curb Extension	•	•		•	•	•	•			•	•	
20. Choker	•			•								
21. Pedestrian Crossing Island	•	•		•	•	•	•					
22. Chicane	•		•	•					•			
23. Minicircle						•	•		•			
24. Speed Humps	•		•	•					•			
25. Speed Table	•	•	•	•					•			
26. Raised Intersection				•		•	•					
27. Raised Ped. Crossing	•	•		•	•	•	•				•	
28. Gateway	•		•	•					•			

Table 3-3. Crash types and associated countermeasures—Continued

Source: Pedestrian Facilities Users Guide⁽⁷⁾

Countermeasure	Midblock Dart/-Dash	Multiple Threat	Midblock Mailbox, etc.	Failure to Yield (Unsignalized)	Bus-Related	Turning Vehicle at an Intersection	Through Vehicle at Intersection	Walking Along Roadway	Working/Playing in Roadway	Not in Road	Backing Vehicle	Crossing Expressway
29. Landscape Options				•						•	•	
30. Paving Treatments				•		•	•					
31. Driveway Link/ Serpentine	•			•					•			
32. Woonerf	•								•			
33. Diverter	•					•	•		•			
34. Full Street Closure	•					•	•		•			
35. Partial Street Closure	•					•	•		•			
36. Pedestrian Street	•			•					•			
37. Traffic Signal	•	•		•	•	•	•					
38. Pedestrian Signal	•	•		•	•	•	•					
39. Pedestrian Signal Timing						•	•					
40. Signal Enhancement	•					•	•					
41. RTOR Restriction						•						
42. Advanced Stop Lines		•			•	•	•					
43. Sign Improvement	•	•	•	•	•	•	•	•	•	•		•
44. School Zone Improvement	•	•		•	•	•	•	•		•		
45. Identify Neighborhood	•		•	•				•	•			
46. Speed-Monitoring Trailer	•		•	•			•	•	•			
47. Park Enhancement	•		•	•	•	•	•			•	•	
48. Ped./Driver Education	•	•	•	•	•	•	•	•	•	•	•	•
49. Police Enforcement	•	•	•	•	•	•	•	•	•	•		•

3.9 Bicycle and Pedestrian Safety Goals

Based on the data from the FHWA study, the following safety goals and research recommendations were made in 1996.⁽³⁾

1. Much of what is reported in this study seems strongly connected to basic walking, riding, and driving patterns—in other words, related to exposure. Future studies of pedestrians and bicyclists and related facilities should be planned with this need in mind.
2. As a measure of accountability, it is recommended that local and State pedestrian-bicycle coordinators continually track crashes in their jurisdictions. A simplified crash typing procedure that coordinators can easily use should be prepared and disseminated.
3. With the current increased interest in both bicycling and walking, crash investigators on the State and local levels should be urged to report completely on any bicyclist and pedestrian crashes, particularly for roadway-related variables.
4. A systemwide approach will be necessary to make safety gains as well as reach the goals of the National Bicycling and Walking Study, namely: (1) to double the number of trips made by bicycling and walking, and (2) to reduce by 10 percent the number of bicyclists and pedestrians injured or killed in traffic collisions. Engineering, education, and enforcement approaches are vital to improved safety. There is a continuing need to establish the mindset that bicyclists and pedestrians are worthy and viable users of our transportation system.

3.10 Geographic Information System (GIS) Crash Frequency Analysis

Geographic information system (GIS) software turns statistical data (e.g., crashes) and geographic data (e.g., roads and crash locations) into meaningful information for spatial analysis and mapping. GIS is an invaluable tool being applied to many pedestrian and bicycle safety issues. It assists in mapping crashes to identify hot spots, planning the safest route to walk or bike based on roadway and traffic elements (sidewalk, curb lane width, crosswalk locations, traffic volume, etc.), and illustrating the relationships between land use, traffic patterns, and bicycle and pedestrian safety. This tool is valuable in helping visualize the data accumulated in crash and roadway databases.

3.11 Benefit-Cost Analysis

Once the crash types have been identified and the appropriate countermeasures selected, the resulting benefit-cost ratio can be calculated. A common formula used for this calculation is the Safety Improvement Index (SII), a formula developed by the Texas Department of Transportation (TxDOT) as part of the Federal Hazard Elimination and Safety (HES) Program to assess the attributes of a safety improvement project and convert it to an index ratio by which each project can be ranked or prioritized in order of importance.^(9,10) In its most basic form, SII is a formula that computes the ratio of the potential reduction in crash costs (the “benefit”) to the cost of implementing the countermeasure (the “cost”). This formulated value is weighted heavily on the percentage of the expected reduction in the number of crashes that occurred prior to the improvement. Reduction factors have been determined through previous studies, such as the TxDOT HES Program and a national survey of comparative crash reduction factors conducted by Texas Transportation Institute (TTI).^(9,11) SII greater than or equal to 1.0 is considered to be cost effective. However, the ratio is not designed to measure the effectiveness of individual projects. Rather, it is a method by which many projects can be compared using the same set of criteria. By way of this comparison, a prioritization list of improvement projects can be formed. With this prioritized list, the projects can be funded beginning with the most important project, and each subsequent safety improvement project is then funded individually and sequentially thereafter.

Some of the other factors included in this index are:

- Percentage reduction factor (the potential a countermeasure has to reduce a crash type).
- Number of fatal and/or incapacitating injury crashes (weighted average cost of these per crash is \$232,700).
- Number of nonincapacitating and/or possible injury crashes (weighted average cost of these per crash is \$16,900).
- Number of property damage only crashes (weighted average cost of these per crash is \$2,220).
- Number of years of crash data (usually 3 years is the minimum number required).
- Projected annual average daily traffic (AADT) at the end of the project service life (a 3–5 percent growth rate in traffic per year is to be expected).
- AADT during the year before the project is implemented.
- Project service life (the useful life of the improvement).

3.12 Student Exercise

The following ideas are suggested for student exercises.

Part 1

Design a program that specifically provides countermeasures aimed at reducing one (or more) common bicycle and/or pedestrian crash types. Countermeasures can include physical changes to the bicycle/pedestrian environment (engineered and constructed solutions), or education programs aimed at a particular audience that may be susceptible to certain crash types. Be specific about what the program would include, and how it would be implemented throughout a community. Include an explanation of how you would propose to evaluate the effectiveness of your program.

Part 2

Using the data provided for the case study location, Piedmont Park in Atlanta, GA, develop some conclusions regarding the crash data obtained through the Georgia Department of Transportation for 1995, 1996, and 1997 (see figures 3-21 through 3-23 and tables 3-4 through 3-7). Cross-tabulations of crashes by time of day, location, and causation factors are helpful in gaining insight into safety problems and possible countermeasures. Data available for such evaluations are often limited due to the low percentage of reported pedestrian and bicycle crashes. However, important information can be obtained by a thorough analysis of available data.

For some general background on the case study location, the following descriptive information is provided:

- Piedmont Park is a large public park located approximately 4.8 km (3 mi) north of the central business district in the midtown area of Atlanta.
- The park is surrounded on all sides by densely populated residential neighborhoods.
- Very little parking is available within the park, and most park users arrive by foot, in-line skates, skateboard, or bicycle.

- The park has extensive walking, running, and bicycling trails, and these are the primary uses of the park. In addition, there are numerous festivals and special events.
- Access to the park from surrounding neighborhoods is via surface streets, most of which have narrow 1.2- to 1.5-meters (m)-wide [4- to 5-feet (ft)-wide] sidewalks.
- The park is bound on all sides by heavily traveled arterial roadways that commonly experience significant peak-hour congestion.
- Two transit stations are located within walking distance near the park and pedestrian access to and from the park links with the stations. Typical sidewalk and crosswalk treatments are used along surface streets (10th St. and 14th St.) to connect with the transit stations. Bicycles are allowed on transit fixed-rail vehicles during all operational periods.

For conducting a case study evaluation of pedestrian and bicycle conditions at Piedmont Park, the data provided include the following:

- Bicycle crash locations (year and location denoted by text boxes in figure 3-21).
- Pedestrian crash locations (year and location denoted by text boxes in figure 3-22).
- Site location map (figure 3-23).
- Tabulation of pedestrian crash data (table 3-4).
- Tabulation of bicycle crash data (table 3-5).
- Usage data collected at major park entrances (table 3-6).
- Summary of major roadways (table 3-7).

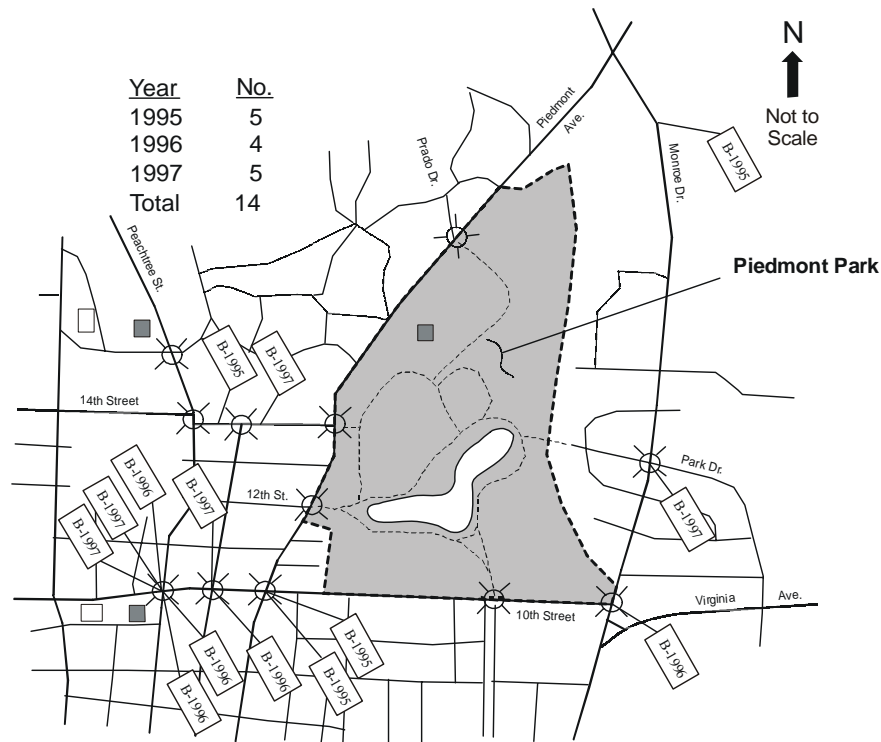

Figure 3-21. Illustration. Bicycle crash locations.

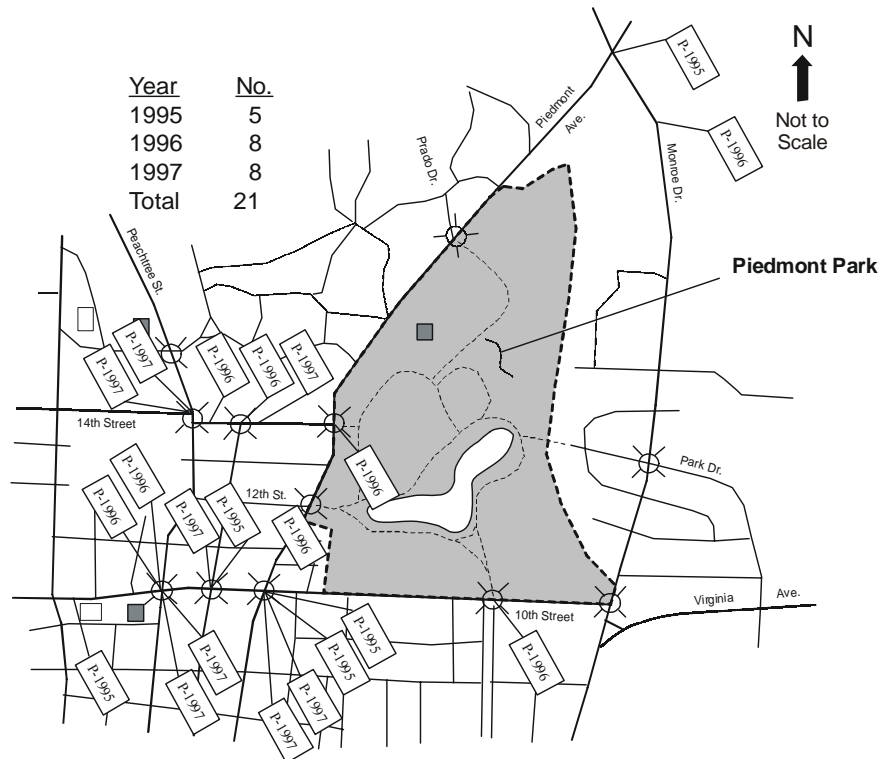

Figure 3-22. Illustration. Pedestrian crash locations.

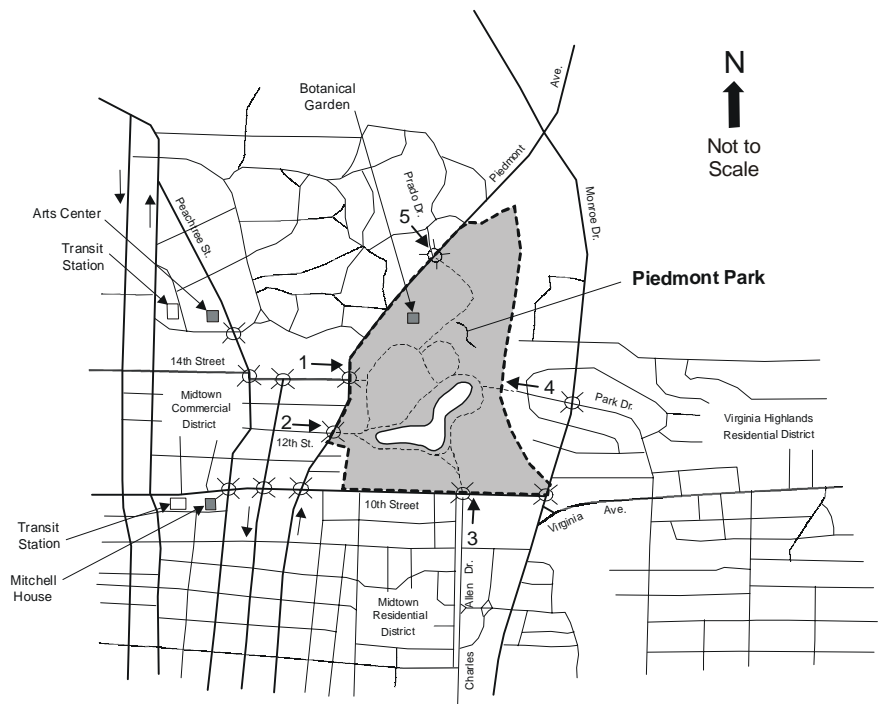

Figure 3-23. Illustration. Site location map.

Table 3-4. Tabulation of pedestrian crash data.

#	Route/- Road	Mile Post	Time	Month	Day	Year	Severity	Location	Type	Light Condition	Surface Condition
1	10th St	1.78	23:29	06	13	1997	Injury	Intersection	Pedestrian	Dk/Lighted	Dry
2	10th St	1.78	13:54	08	25	1997	Injury	Intersection	Pedestrian	Daylight	Dry
3	10th St	1.87	23:01	06	19	1997	Injury	Intersection	Pedestrian	Dk/Lighted	Dry
4	10th St	1.99	19:19	02	06	1997	Injury	Intersection	Pedestrian	Dk/Lighted	Dry
5	10th St	1.99	17:26	07	08	1997	Injury	Intersection	Pedestrian	Daylight	Dry
6	14th St	0.06	15:00	04	04	1997	Injury	Intersection	Pedestrian	Daylight	Dry
7	14th St	0.06	18:00	03	03	1997	Injury	Intersection	Pedestrian	Daylight	Dry
8	14th St	0.00	09:30	06	10	1997	Injury	Intersection	Pedestrian	Daylight	Dry
9	Monroe	5.71	16:12	09	21	1996	Injury	Road Segment	Pedestrian	Daylight	Dry
10	10th St	2.43	15:45	09	07	1996	Injury	Intersection	Pedestrian	Daylight	Dry
11	10th St	1.78	19:50	07	04	1996	Injury	Intersection	Pedestrian	Daylight	Dry
12	10th St	1.78	22:05	07	13	1996	Injury	Intersection	Pedestrian	Dk/Lighted	Dry
13	10th St	2.01	21:30	06	29	1996	Injury	Road Segment	Pedestrian	Dk/Lighted	Dry
14	14th St	0.00	17:10	08	05	1996	Injury	Intersection	Pedestrian	Daylight	Dry
15	14th St	0.06	13:00	03	13	1996	Injury	Intersection	Pedestrian	Daylight	Dry
16	Pied.	1.01	22:20	04	25	1995	Injury	Intersection	Pedestrian	Dk/Lighted	Dry
17	Monroe	5.97	23:06	02	10	1995	Injury	Intersection	Pedestrian	Dk/Lighted	Dry
18	10th St	1.64	18:20	01	11	1995	Injury	Road Segment	Pedestrian	Dusk	Dry
19	10th St	1.87	17:25	02	08	1995	Injury	Intersection	Pedestrian	Daylight	Dry
20	10th St	1.99	21:00	10	17	1995	Injury	Intersection	Pedestrian	Dk/Lighted	Dry
21	10th St	1.99	02:23	01	21	1995	Injury	Intersection	Pedestrian	Dk/Lighted	Dry

Table 3-5. Tabulation of bicycle crash data.

#	Route/- Road	Mile Post	Time	Month	Day	Year	Severity	Location	Type	Light Condition	Surface Condition
1	Monroe	5.14	19:00	09	17	1997	Injury	Intersection	Angle Intersecting	Daylight	Dry
2	10th St	1.78	12:20	03	14	1997	Injury	Intersection	Angle Intersecting	Daylight	Dry
3	10th St	1.78	17:32	08	29	1997	Injury	Intersection	Angle Intersecting	Daylight	Dry
4	10th St	1.87	17:43	03	11	1997	Injury	Intersection	Head On	Daylight	Dry
5	14th St	0.00	18:10	12	17	1997	Injury	Intersection	Angle Intersecting	Dk/Lighted	Dry
6	Monroe	4.85	01:15	05	05	1996	Injury	Intersection	Rear End	Dk/Lighted	Dry
7	10th St	1.78	15:33	12	18	1996	PDO	Intersection	Sideswipe Same Dir	Daylight	Dry
8	10th St	1.78	18:30	12	27	1996	PDO	Intersection	Angle Intersecting	Dk/Lighted	Dry
9	10th St	1.87	21:45	02	09	1996	PDO	Intersection	Angle Intersecting	Dk/Lighted	Dry
10	Monroe	5.81	17:15	09	02	1995	PDO	Road Segment	Angle Intersecting	Daylight	Dry
11	10th St	1.78	12:22	02	23	1995	Injury	Intersection	Angle Intersecting	Daylight	Dry
12	10th St	1.99	16:40	09	29	1995	Injury	Intersection	Angle Intersecting	Daylight	Dry
13	10th St	1.99	17:50	08	03	1995	Injury	Intersection	Angle Intersecting	Daylight	Dry
14	14th St	0.00	17:45	09	11	1995	Injury	Intersection	Rear End	Daylight	Dry

Note: PDO = property damage only crash

Table 3-6. Usage data collected at major park entrances.

No.	Entrance Location	Time of Day	Total for all interaction movements ⁽¹⁾			
			Bicyclists	In-line skaters ⁽²⁾	Pedestrians ⁽³⁾	Total HPT Activity
1 ⁽⁴⁾	Piedmont at 14th St	4:24–4:40 p.m.	3	2	22	27
1 ⁽⁴⁾	Piedmont at 14th St	5–5:15 p.m.	2	3	29	34
2	Piedmont at 12th St	4:40–4:55 p.m.	6	4	12	22
3	10th St at Charles Allen	5:20–5:35 p.m.	3	6	42	51
4	Park Avenue at Elmwood	5:40–5:55 p.m.	7	5	18	33

Notes:

- (1) Conditions were sunny and clear, temperature approximately 32 degrees Celsius (90 degrees Fahrenheit). Count duration was for a total of 15 minutes for each spot count location.
- (2) Count tabulations include occasional skateboarders.
- (3) Count tabulations include joggers and people with baby strollers.
- (4) Piedmont Avenue at 14th St was counted twice to evaluate peaking characteristics.

Table 3-7. Summary of major roadways.

No.	Roadway	Mileposts	No. of Lanes	Speed Limit km/h (mi/h)	1997 ADT	Total Length km (mi)
1	Piedmont Section 1	0.65–1.01	3 (one way) 4	56 (35)	11,700	2.1 (1.3)
	Section 2	1.01–1.93		56 (35)	26,400	
2	10th St	1.56–2.68	4	56 (35)	20,420	1.8 (1.1)
3	14th St Section 1	0.00–0.23	4	56 (35)	22,400	0.5 (0.3)
	Section 2	0.00–0.06	4	56 (35)	17,500	
4	Monroe	4.85–5.97	4	56 (35)	20,500	1.8 (1.1)

Part 3

Obtain pedestrian and bicycle crash data for an area of interest. You should obtain a minimum of three years of data to support your crash analysis. Although local city agencies sometimes maintain crash data, the State DOT is the most reliable source of available data. Most States maintain their crash data in a computerized database system and sorts of the data can be conducted on various field entries to list crashes associated with either pedestrians or bicycles. These types of crashes will only constitute a very small percentage of the total crashes occurring along a roadway and it may be useful to receive a full listing of all the crashes associated with your location of interest. DOTs may only maintain data along the more significant roadways and often do not include subdivision/residential streets.

Most DOT personnel are very helpful and willing to work to get you the data you need. You should clearly explain your intentions, location of interest, and type of data that you would like to obtain. Submitting a request in writing is typically required so that your data request can be efficiently processed through their system. In addition to the crash data, you may need other information that will allow you to decode the crash data and to physically link the crash to a location on the roadway network. A crash investigation manual is usually available that lists all of the coded entries used in creating aggregated crash tabulations. Also, a roadway features log is typically available to link milepost listings to physical map features such as intersections, bridges, and street names. In the initial phases of conducting an analysis of crashes, it is seldom necessary to access the actual crash reports. It is much more useful to utilize aggregated crash records that are available through the crash data system. Allow ample time for

DOT personnel to accommodate your request within their day-to-day workload. Generally, data can be received in two to three weeks after submitting a request.

3.13 References and Additional Resources

The references for this lesson are:

1. *Traffic Safety Facts 2003: Pedalcyclists*, Technical Summary, Publication No. DOT-HS-809-768, NHTSA, Washington, DC, 2004 (see <http://www.nhtsa.gov/> for most recent statistics available).
2. *Traffic Safety Facts 2003: Pedestrians*, Technical Summary, Publication No. DOT-HS-809-769, NHTSA, Washington, DC, 2004 (see <http://www.nhtsa.gov/> for most recent statistics available).
3. Hunter, W.W., J.C. Stutts, W.E. Pein, and C.L. Cox, *Pedestrian and Bicycle Crash Types of the Early 1990's* [sic], Technical Summary, Publication No. FHWA-RD-95-163, FHWA, Washington, DC, June 1996.
4. Stutts, J.C. and W.W. Hunter, *Injuries to Pedestrians and Bicyclists: An Analysis Based on Hospital Emergency Departmental Data*, Final Report, Publication No. FHWA-RD-99-078, FHWA, Washington, DC, November 1999. Available online at <http://www.tfhr.gov/safety/pedbike/research/99078/99-078.htm>.
5. Hunter, W.W., J.C. Stutts, and W.E. Pein, *Pedestrian Crash Types: A 1990's* [sic] *Informational Guide*, Publication No. FHWA-RD-96-163, FHWA, Washington, DC, April 1997.
6. Hunter, W.W., J.C. Stutts, and W.E. Pein, *Bicycle Crash Types: A 1990's* [sic] *Informational Guide*, Publication No. FHWA-RD-96-104, FHWA, Washington, DC, April 1997.
7. *Pedestrian Facilities Users Guide—Providing Safety and Mobility*, FHWA, Publication No. FHWA-RD-01-102, McLean, VA, March 2002, available online at <http://www.walkinginfo.org/pdf/peduserguide/peduserguide.pdf>, accessed August 12, 2005.
8. Image Library, PBIC, available online at <http://www.pedbikeimages.org>, accessed May 6, 2004.
9. TxDOT, “Chapter 2—Hazard Elimination Program—Safety Improvement Index,” *Traffic Operations Manual*, Austin, TX, 1999.
10. McFarland, William F. et al, “Benefit-Cost Analysis for Evaluating Safety Improvement Projects,” Texas Transportation Institute, Houston, TX, Unpublished Report No. 1484, 2001.
11. “Appendix I: Summary of Accident Reduction Factors Used in Other States,” *Houston East End Safety Study*, Final Report, Center for Transportation Safety, Texas Transportation Institute, Houston, TX, February 2004. Available online at <http://www.h-gac.com/HGAC/Departments/Transportation/Safety/Safety.htm>.

Additional resources for this lesson include:

- http://safety.fhwa.dot.gov/ped_bike/bike/bike_tools.htm. Has information on bicycle safety, PBCAT, and a bicycle safety resource guide and database of thousands of links to bicyclist information and safety countermeasures.

- **<http://www.bicyclinginfo.org/>**. Contains fact sheets, statistics, surveys, cost and ridership studies, and other bicyclist/ped links.
- **<http://www.dot.state.tx.us/business/avgd.htm>**. This is the Texas Statewide Average Low Bid Unit Price for construction and maintenance contracts Web page. It displays the average unit costs based on the previous year's competitive bid construction contracts. Bid items include everything from earth work to paint striping, traffic signals to landscaping. This information is useful in conducting SII benefit-cost calculations.
- **<http://www.transtats.bts.gov/>**. Click on the Bike/Pedestrian mode to explore databases like the Fatality Analysis Reporting System (FARS), or the Nationwide Personal Transportation Survey (NPTS) that provides data on the amount and nature of pedestrian travel.
- **<http://www.walkinginfo.org/>**. Offers a general overview of pedestrian safety, activities, design, etc.
- **<http://www.walkinginfo.org/pedsafe/crashstats.cfm#locationtype>**. Provides crash statistics, crash type analysis, and countermeasures.

LESSON 4:

BICYCLE AND PEDESTRIAN PLANNING

4.1 Introduction

The rising awareness of bicycle and pedestrian issues in transportation planning has brought with it a new era of planning for these modes. Planning strategies range from small scale (such as a study to improve bicycle and pedestrian access to a neighborhood bus stop) to large scale (such as a statewide master plan for bicycling and walking). Additionally, bicycle and pedestrian planning includes planning provisions to make streets accessible for all users, including those with disabilities. Increasing the accessibility for users with disabilities increases the accessibility for all users.

While there are some common elements (such as public participation) that nearly all bicycle and pedestrian planning projects should include, such projects otherwise can vary greatly, depending upon the particular situation. An effective, interconnected system of bicycle and pedestrian facilities requires planning at a variety of levels. This lesson provides an overview of bicycle and pedestrian planning issues, and it presents a variety of model master planning processes that can be used at various levels of government.

- 4.1 Introduction
- 4.2 Federal Requirements for Planning
- 4.3 Statewide and Regional Pedestrian and Bicycle Plans
- 4.4 Local Bicycle and Pedestrian Plans
- 4.5 Forecasting Bicycle and Pedestrian Travel Demand
- 4.6 Using Models to Evaluate Roadway Conditions for Bicycling and Walking
- 4.7 Mapping
- 4.8 Student Exercise
- 4.9 References and Additional Resources

4.2 Federal Requirements for Planning

As discussed in detail in lesson 1, section 5, government commitment and support has been critical to improving conditions for bicycling and walking throughout the United States. Efforts to plan for bicycle and pedestrian mobility were given a tremendous boost by ISTEA and subsequent transportation legislation that has had a continuing emphasis on multimodal transportation. As a result of Federal legislation, States and MPOs are required to address bicycle and pedestrian needs during the transportation planning process.

States and MPOs are required to incorporate appropriate provisions for bicycling and walking into the State transportation improvement program (STIP) and transportation improvement programs (TIPs). In addition, each State is required to establish a bicycle and pedestrian coordinator position in its State DOT. AASHTO maintains an online list of current State bicycle and pedestrian coordinators on the AASHTO website at <http://design.transportation.org/?siteid=59&pageid=852>.

The FHWA and Federal Transit Administration (FTA) have issued technical guidance for bicycle and pedestrian planning at the State and MPO levels in order to meet Federal requirements.

In brief, this guidance makes the following key points relevant to State and metropolitan area transportation planning for bicycles and pedestrians:

- Plan elements should include goals, policy statements, and specific programs and projects whenever possible.
- The plan should identify financial resources necessary for implementation.
- Bicycle and pedestrian projects may be onroad or off-road facilities. Off-road trails that serve valid transportation purposes as connections between origins and destinations are considered eligible projects consistent with the planning process.
- Any regionally significant bicycle or pedestrian project funded by or requiring an action by FHWA or FTA must be included in the metropolitan TIP.
- Bicycle and pedestrian elements of transportation plans should include:
 - Vision and goal statements and performance criteria.
 - Assessment of current conditions and needs.
 - Identification of activities required to meet the vision and goals.
 - Implementation of the bicycle and pedestrian elements in statewide and MPO transportation plans and TIPs.
 - Evaluation of progress using performance measures.
 - Public involvement as required by Federal transportation legislation and FHWA/FTA planning regulations.
 - Transportation conformity requirements for air quality, where necessary.

4.3 Statewide and Regional Pedestrian and Bicycle Plans

Statewide Bicycle and/or Pedestrian Plans

At the State level, bicycle and pedestrian plans establish policies, goals, and actions for State agencies (i.e., within a State DOT and transit agencies) to accommodate and improve conditions for biking and walking. These plans often include design standards/guidance for local and regional governments, and they typically address education and safety issues as well.

The primary objective of a statewide bicycle and pedestrian access plan is to guide future transportation projects in the State, and to establish programs that support and encourage bicycling and walking. The following types of activities may be included in a statewide bicycle and pedestrian planning process:

- Public outreach that spans all geographic and jurisdictional regions of the State, and jurisdictional outreach that ensures the involvement of local stakeholders.
- Assessment of existing facilities, planning activities, programs, and policies. This may include extensive analysis of the current transportation system to identify deficiencies as well as an analysis of travel patterns and opportunities.

- Identification of policies and legal barriers to implementing bicycle and pedestrian improvements (including zoning and subdivision regulations) and development of strategies to address these barriers.
- Prioritization of locations needing improvements (based on existing conditions analysis and a relative assessment of demand), prioritization of programs, and other actions needed in order to support pedestrian and bicycle transportation.
- A phased implementation plan that identifies specific recommended actions, identifies the jurisdictions and/or agencies responsible for each action, assigns an estimated cost to each action, and identifies a timeframe for implementing the plan.

Bicycle and pedestrian assessments and recommendations are often grouped together for planning projects but the needs of both groups are often quite different. For this reason, bicycle and pedestrian plans at the statewide level should include separate and distinct recommendations for each mode.

Regional Bicycle and/or Pedestrian Plans

At the regional level, bicycle and pedestrian planning is usually carried out by MPOs, county governments, or similar regional agencies. The main objectives of these planning projects are usually to coordinate between jurisdictions, develop planning and design guidance for local governments, establish regional priorities for funding, and build a unified regional approach to land use and transportation issues. Issues that typically arise during the regional planning process include:

- Ensuring that proposed trails and bikeways are continuous, despite jurisdictional boundaries within the region.
- Resolving conflicting standards and philosophies among regional entities—each county or town may have somewhat different ideas about bicycle and pedestrian transportation and a different set of facility and street standards.
- Reconciling potential conflicts between local and regional perspectives, particularly when funding priorities are being established.

4.4 Local Bicycle and Pedestrian Plans

Cities and towns with good bicycle and pedestrian plans can have a very positive impact on bicycling and walking conditions. Decisions at the local level often have a more direct and immediate impact on bicycling and walking because these two modes are affected to a great extent by localized opportunities and constraints.

In order to compete successfully for Federal funding, the local entity must demonstrate a commitment to providing matching funds, and it should come equipped with the specifics of projects, cost-estimates, and other information. The city that does its homework has the best chance of securing the funds.

It is important to recognize that there is no single, perfect formula for completing a local pedestrian and/or bicycle master plan. Successful planning processes are tailored to the needs and opportunities of a particular local area. A successful planning process for one city or town might be a failure somewhere else. Bicycle and pedestrian plans are inherently political and must respond to the opportunities and constraints of the government that develops them. Each planning process must begin with a strategic assessment of the critical path to success, and it should focus in on those activities, projects, and recommendations that are most likely to yield results.

For example, if the jurisdiction is preparing to embark on a comprehensive revision of local zoning and subdivision regulations, a strategic approach would be to focus the work of the bicycle and pedestrian plan on developing very specific recommended policies that can be incorporated into the revisions.

Despite the differences among bicycle and pedestrian plans, there are some features that many local bicycle and pedestrian plans have in common:

- Public involvement among a wide variety of stakeholders. This can include neighborhood walkability audits, public workshops, survey questionnaires, interactive websites about the project, and other measures.
- Use of geographic information systems (GIS) to document locations of existing facilities (including sidewalk coverage, trails and bikeways, locations of destinations) and to indicate the conditions for bicycling and walking on existing roadways.
- Comprehensive review of transportation and land use policies and procedures in order to identify longstanding practices that make bicycling and walking difficult and specific recommendations for policy changes.
- Establishment of key design procedures in order to systematically retrofit environments which create barriers to bicycling and walking. Examples include instituting FHWA crosswalk guidelines (see lesson 11), establishing standard curb ramp designs that meet FHWA guidelines, and establishing a process for assessing repaving schedules to determine if bike lanes can be incorporated during restriping.
- Identification and prioritization of specific locations where improvements are needed, initially focusing on areas where bicycle and pedestrian activity is already prevalent but conditions are poor. The list of improvements may include: widening intersection crossings, closing gaps in the sidewalk or bikeway network, making small area plans for neighborhoods or specific commercial areas, identifying streets that are excessively wide and are candidates for road diets (narrowing the roadway to provide more space for bicyclists and pedestrians), and locating areas that need traffic calming improvements, etc.

Setting Priorities

One approach in setting priorities for pedestrian and bicycle improvements is to identify what would encourage people to walk more often and then orient efforts toward improving conditions for pedestrians in this direction. During the development of the bicycle and pedestrian plan for Louisiana, citizens were asked what could be done to make it easier to get around by foot. The responses were ranked as follows:

1. More sidewalks	61.9 percent
2. More off-road trails	57.8 percent
3. Destinations close to home and work	33.9 percent
4. Education for motorists	30.3 percent
5. Enforcement of bicyclist/motor vehicle laws	28.4 percent
6. More benches, water fountains, etc.	28.4 percent
7. More crosswalks	27.1 percent
8. Slower traffic on local roads	21.6 percent
9. Better transit service	15.1 percent

Of course, some projects are expensive. For instance, if there is a need for a grade-separated pedestrian crossing of a freeway, such a project can easily cost upwards of \$300,000 to \$500,000. Planning for such an expenditure can take several years and may involve grant applications or implementation through the

TIP process and the use of any one of several categories of Federal funds. Meanwhile, many small but important changes can be made to improve conditions for bicycling and walking.

Many local programs have found that small initial successes build momentum, allowing more ambitious work to follow. In one western community, for instance, installation of several test traffic circles on residential streets—a project that took several days of work and less than \$5,000 to accomplish—helped build support for an ongoing program installing such circles all over town.

Developing a Bicycle Network Plan

The following discussion details a planning process for a bicycle network plan. Chapter 1 of the *AASHTO Guide for the Development of Bicycle Facilities* contains several suggestions for establishing a bicycle planning program. The following process is but one example. It consists of six steps:⁽¹⁾

1. Establish performance criteria for the bicycle network.
2. Inventory the existing bicycle facility and roadway system.
3. Identify desired bicycle travel lines and corridors.
4. Evaluate and select specific route alternatives.
5. Select appropriate design treatments.
6. Evaluate the finished plan against the established performance criteria.

Establish Performance Criteria for the Bicycle Network. Performance criteria define the important qualitative and quantitative variables to be considered in determining the desirability and effectiveness of a bicycle facility network. These can include:

- **Accessibility:** This is measured by the distance a bicycle facility is from a specified trip origin or destination, the ease by which this distance can be traveled by bicycle, and the extent to which all likely origins and destinations are served. Some communities (e.g., Arlington, VA) have adopted a criterion of having a bicycle facility within 1.61 km (1 mi) of every residence. More importantly, no residential area or high-priority destination (school, shopping center, business center, or park) should be denied reasonable access by bicycle.
- **Directness:** Studies have shown that most bicyclists will not use even the best bicycle facility if it greatly increases the travel distance or trip time over that provided by less desirable alternatives. Therefore, routes should still be reasonably direct. The ratio of directness to comfort/perceived safety involved in this trade-off will vary depending on the characteristics of the bicycle facility (how desirable is it?), its more direct alternatives (how unpleasant are they?), and the typical user's needs (in a hurry? is it a business or pleasure trip?).
- **Continuity:** The proposed network should have as few missing links as possible. If gaps exist, they should not include traffic environments that are unpleasant or threatening to group B/C (basic and child) riders, such as high-volume or high-speed motor vehicle traffic with narrow outside lanes.
- **Route attractiveness:** This can encompass such factors as separation from motor traffic, visual aesthetics, and the real or perceived threat to personal safety along the facility (see figure 4-1).
- **Low conflict:** The route should present few conflicts between bicyclists and motor vehicle operators.
- **Cost:** This would include the costs both to establish and to maintain the system.
- **Ease of implementation:** The ease or difficulty in implementing proposed changes depends on available space and existing traffic operations and patterns.



Figure 4-1. Photo. Group B (basic) bicyclists value designated bike facilities such as bike lanes.

Inventory Existing System. Both the existing roadway system and any existing bicycle facilities should be inventoried and evaluated. The condition, location, and level of use of existing bicycle facilities should be recorded to determine if they warrant incorporation into the proposed new network or if they should be removed. If existing bicycle facilities are to be used as the nucleus of a new or expanded network, the inventory should note which improvements to the existing portions of the network may be required to bring the entire new network up to uniform design and operations standards.

A simple inventory of the roadway system could be based on a map of the AADT counts on each road segment within a community or region. A more complex inventory could include factors such as the number of traffic lanes, the width of the outside lane, the posted speed limit or actual average operating speed, the pavement condition, and certain geometric and other factors (e.g., the frequency of commercial driveways, grades, and railroad crossings).

Identify Bicycle Travel Corridors. Predicting bicycle travel corridors for a community is not the same as identifying the routes that bicyclists currently use. Instead, travel corridors can be thought of as desire lines connecting neighborhoods that generate bicycling trips with other zones that attract a significant number of bicycling trips.

For motor vehicle traffic, most peak morning trips are made from residential neighborhoods to employment centers. In the evening peak hours, the reverse is true. Furthermore, in the evenings or on weekends, the patterns of trip generation are much more dispersed, as people travel to shopping centers, parks, and the homes of friends or relatives.

Estimating these trip flows for an entire city can be a complex, time-consuming effort requiring significant amounts of raw data and sophisticated computer models. Fortunately, transportation planning for bicycles is much simpler. Unlike traditional transportation planning that attempts to predict travel demands between future zones on as-yet unbuilt streets and highways, bicycle planning attempts to provide for bicycle use based on existing land uses, assuming that the present impediments to bicycle use

are removed. These desire lines are, in fact, well represented by the traffic flow on the existing system of streets and highways.

In all of this, the underlying assumption is that people on bikes want to go to the same places as do people in cars (within the constraints imposed by distance), and the existing system of streets and highways reflects the existing travel demands of the community. Furthermore, most adults have a mental map of their community based on their experience as motor vehicle operators. Thus, they tend to orient themselves by the location of major streets and highways.

Again, it is important to note that the resulting map may not be a representation of where bicyclists are now, but is instead a reflection of where bicyclists wish to go. The actual travel patterns of group B/C bicyclists are heavily influenced by their perception of the bicycling environment they face. Uncomfortable or threatening bicycling conditions will cause these bicyclists to alter route choice from their most preferred alignment, choose a different travel mode, or not make the trip at all. Thus, the task of the transportation planner for bicycling is to ask, “Where are the bicyclists now?” and “Where would they be if they could go where they preferred?”

Although this use of existing traffic flows is a useful overall predictor of bicyclists’ desire lines, a few special situations may require adjustments to the corridor map:

- Schools (especially colleges and universities) and military bases can generate a disproportionately large share of bicycle trips. This is especially true for campuses where motor vehicle parking is limited.
- Parks, beaches, libraries, greenways, rivers and lakesides, scenic roads, and other recreational facilities attract a proportionately higher percentage of bicycle trips.

Evaluate and Select Specific Route Alternatives. The corridor identification procedure identifies desire lines for bicycle travel between various locations. The next step is to select specific routes within these corridors that can be designed or adapted to accommodate group B/C bicyclists and provide access to and from these locations. The aim is to identify the routes that best meet the performance criteria established in the first step of this planning process.

Typically, this step and the selection of appropriate design treatments are highly interactive processes. The practicality of adapting a particular route to accommodate group B/C bicyclists may vary widely depending upon the type of design treatment selected. For example, a less direct route may become the best option if comparatively few inexpensive and easily implemented design improvements are required.

Therefore, steps 4 and 5 should be approached as an iterative loop in which both route selection and design treatment are considered together to achieve a network that is highly advantageous to the user, is affordable, has few negative impacts on neighbors and other nonusers, and can be readily implemented.

In summary, the selection of a specific route alternative is a function of several factors, including:

- The degree to which a specific route meets the needs of the anticipated users as opposed to other route options.
- The possible cost and extent of construction required to implement the proposed bicycle facility treatment.

- The comparative ease of implementing the proposed design treatment (see figure 4-2). For example, one option may entail the often unpopular decision to alter or eliminate on-street parking while another does not.
- The opportunity to implement the proposed design treatment in conjunction with a planned highway construction or reconstruction project.

A more inclusive list of factors to be considered in the selection of a specific route is presented in the *AASHTO Guide*.⁽¹⁾



(This picture shows bicyclists not wearing helmets. FHWA strongly recommends that all bicyclists wear helmets.)

Figure 4-2. Photo. Several factors will determine the final design treatment used; two of the foremost are cost and controversy.

Select Appropriate Design Treatments. Guidelines for selecting an appropriate design treatment are presented in lesson 13 of this course. In overview, the principal variables affecting the applicability of a design treatment are:

- The design bicyclist: Is the proposed route projected to be used primarily by group A (advanced) bicyclists, or is it intended to also serve as part of a network of routes for group B/C bicyclists?
- The type of roadway project involved with the selected route: Is the roadway scheduled for construction or reconstruction, or will the incorporation of design improvements be retrofitted into existing geometrics or right-of-way widths?

- Traffic operations factors: The most significant traffic operations factors for determining the appropriateness of various design treatments are:
 - Traffic volume.
 - Average motor vehicle operating speeds.
 - Traffic mix.
 - On-street parking.
 - Sight distance.
 - Number of intersections and entrances.

Evaluate the Finished Plan Against the Established Performance Criteria. Will the proposed network meet the criteria established at the start of the planning process? If it does not meet most of these criteria, or it inadequately meets a few critical goals, either the proposal will require further work, or the performance criteria must be modified. In the latter case, the planning process as a whole should be reviewed to determine if previously discarded routes should be reconsidered. There may now be more preferred options in light of the newly modified criteria.

This reality check is important. Many well-considered proposals fail when it is determined that the finished product no longer meets its established objectives.⁽²⁾

4.5 Forecasting Bicycle and Pedestrian Travel Demand

The bicycling and walking modes have experienced decades of neglect in mainstream travel demand forecasting. As cities and towns begin the work of redeveloping their transportation systems to support bicycling and walking, the list of needed improvements far outstrips available dollars. Planners have begun to look for ways to set priorities—one of which is predicting demand.

The question that planners have begun to ask is this: If we build this bikeway (or walkway, etc.), how many people can we expect to use it?

Finding the answer is the fundamental aspect of predicting demand. Transportation planners have been asking (and answering) this question for motor vehicular travel since the late 1960s, when the first travel demand models were developed. By contrast, bicycle and pedestrian researchers are only just beginning to scratch the surface on these topics.

For bicycles and pedestrians to have a seat around the transportation table, it is important to acknowledge that some level of analysis must be done for these modes. Transportation planners have a responsibility to ensure that public funds are being spent wisely—in locations where a larger number of people will benefit from new facilities. Finally, there is a growing trend to quantify the air quality benefits (and congestion relief) that can be expected as a result of congestion mitigation and air quality (CMAQ) projects. For bike and pedestrian facilities, this means coming up with some way to determine how many auto trips will be shifted to biking and walking trips.

While the science of predicting bicycle and pedestrian travel demand has not yet been developed to the same level as motor vehicle planning, there are a number of methods that planners have developed over the years to help quantify which locations have higher levels of demand. When planning bicycle and/or pedestrian facilities, it is important to remember that current volumes usually do not reflect demand for two reasons:

1. Existing conditions and gaps in the network result in fewer users—potential users are deterred by dangerous conditions.

2. Dispersed land uses create trip distances that are perceived as being too far to make on foot or by bicycle.

There are two methods of determining demand for pedestrian and bicycle facilities: the intuitive approach versus the use of demand forecasting models. The intuitive approach is less time consuming; however, it does not yield precise results. This type of planning analysis is also called a sketch plan. A sketch plan typically focuses on proximity between origins and destinations, since distance is a primary factor in the initial decision to take a walking or bicycling trip. According to the 1995 Nationwide Personal Transportation Survey (NPTS), the majority of pedestrian trips are 0.4 km (0.25 mi) or less, with 1.6 km (1 mi) generally being the limit that most people are willing to travel on foot. In other words, most people are willing to take a five to ten minute walk at a comfortable pace to reach a destination. The majority of bicycle trips are 4.8 km (3 mi) or less—or about a 15-minute bike ride.⁽³⁾

NHTS data also show that land use patterns and population density have a big impact on trip distance. Higher-density communities with mixed land use patterns will have higher levels of walking because destinations are more likely to be located within walking distance of homes and businesses.⁽⁴⁾

For an intuitive (i.e., sketch plan) approach, destinations throughout the study area that would attract bicyclists and pedestrians are shown on a base map. Routes are selected that serve higher concentrations of destination points or that serve destinations that typically yield high numbers of bicyclists and pedestrians, such as universities, downtown areas, shopping centers, major employment centers (hospitals, business parks, major industries, and corporations, etc.), schools, and parks. Route selection and prioritization can be done via graphical representation; the intent is to identify locations that serve multiple destinations and higher population densities (population densities can be obtained from census data). This methodology can be accomplished using GIS, or it can be done by hand.

Public involvement is important to the success of the intuitive method. It is particularly important to gain input from a wide variety of local citizens (representing different geographic areas) who represent all ages and abilities.

The other method of estimating latent bicycle and pedestrian travel demand is to adjust conventional motor vehicle travel demand theory so that it applies to bicycle and pedestrian travel. By using a gravity model to measure latent bicycle and pedestrian travel demand, the planner can achieve results that are more precise than the intuitive approach. Another advantage to this approach is that it complements the type of analysis that is typically done for motor vehicle and transit travel simulation. This can be particularly important in cases where bicycle improvements are competing for similar funding mechanisms as other modes, since most TIPs make funding decisions based upon quantifiable results.

Bicycle and pedestrian travel demand modeling can be done on a system-wide basis, or at the corridor level. Further information on more precise bicycle and pedestrian travel demand methods is provided in the FHWA *Guidebook on Methods to Estimate Non-Motorized [sic] Travel*.⁽⁵⁾

4.6 Using Models to Evaluate Roadway Conditions for Bicycling and Walking

Level of service (LOS) is a framework that transportation professionals use to describe existing conditions (or suitability) for a mode of travel in a transportation system. The traffic planning and engineering discipline has used LOS models for motor vehicles for several decades. Motor vehicle LOS is based on average speed and travel time for motorists traveling in a particular roadway corridor. In the 1990s, new thinking and research contributed to the development of methodologies for assessing levels of service for other travel modes, including bicycling, walking, and transit (see figure 4-3).



(This picture shows bicyclists not wearing helmets. FHWA strongly recommends that all bicyclists wear helmets.)

Figure 4-3. Photo. Streets and roadways can be analyzed to determine the relative LOS they provide to bicyclists and pedestrians.

Specific methodologies for bicycle LOS have been developed and used by a number of cities, counties, and States since the mid-1990s. There are two models that have been established and are widely used for evaluating bicycling conditions in the United States: one that was developed by FHWA and the other developed and tested by the Florida DOT.

When considering LOS in a multimodal context, it is important to note that LOS measures for motor vehicles and bicycles are based on different criteria and are calculated using different inputs. Motor vehicle LOS is primarily a measure of speed, travel time, and intersection delay. Bicycle LOS is a more complex calculation that represents the level of comfort a bicyclist experiences in relation to motor vehicle traffic.

Bicycle LOS

Bicycle LOS is an evaluation of bicyclists' perceived safety and comfort with respect to motor vehicle traffic while traveling in a roadway corridor. It identifies the quality of service for bicyclists or pedestrians that currently exists within the roadway environment.

In order to evaluate bicycle LOS, a statistically-calibrated mathematical equation is used to estimate bicycling conditions in a shared roadway environment. It uses the same measurable traffic and roadway factors that transportation planners and engineers use for other travel modes. With statistical precision, this modeling procedure clearly reflects the effect on bicycling suitability or compatibility of factors such

as roadway width, bike lane widths and striping combinations, traffic volume, pavement surface condition, motor vehicle speed and type, and on-street parking. The form of the bicycle LOS model is provided as shown below in figure 4-4.

$$\text{Bicycle LOS} = a_1 \ln(\text{Vol}_{15}/L_n) + a_2 \text{SP}_t(1+10.38\text{HV})^2 + a_3(1/\text{PR}_5)^2 + a_4(W_e)^2 + C$$

Figure 4-4. Equation. Bicycle LOS.

Vol_{15} = Volume of directional traffic in 15 minute time period

$$\text{Vol}_{15} = (\text{ADT} \times D \times K_d) / (4 \times \text{PHF})$$

where:

ADT = Average daily traffic on the segment or link

D = Directional factor (assumed = 0.565)

K_d = Peak-to-daily factor (assumed = 0.1)

PHF = Peak-hour factor (assumed = 1.0)

L_n = Total number of directional *through* lanes

SP_t = Effective speed limit

$$\text{SP}_t = 1.1199 \ln(\text{SP}_p - 20) + 0.8103$$

where:

SP_p = Posted speed limit (a surrogate for average running speed)

HV = Percentage of heavy vehicles (as defined in the 1994 *Highway Capacity Manual*)

PR_5 = FHWA five-point pavement surface condition rating

W_e = Average effective width of outside through lane:

where:

$$W_e = W_v - (10 \text{ ft} \times \% \text{ OSPA}) \quad \text{and } W_1 = 0$$

$$W_e = W_v + W_1(1 - 2 \times \% \text{ OSPA}) \quad \text{and } W_1 > 0 \ \& \ W_{ps} = 0$$

$$W_e = W_v + W_1 - 2(10 \times \% \text{ OSPA}) \quad \text{and } W_1 > 0 \ \& \ W_{ps} > 0 \ \text{and a bike lane exists}$$

where:

W_t = Total width of outside lane (and shoulder) pavement

OSPA = Percentage of segment with occupied on-street parking

W_1 = Width of paving between the outside lane stripe and the edge of pavement

W_{ps} = Width of pavement striped for on-street parking

W_v = Effective width as a function of traffic volume

where:

$$W_v = W_t \quad \text{if } \text{ADT} > 4,000 \text{veh/day}$$

$$W_v = W_t(2 - 0.00025 \times \text{ADT}) \quad \text{if } \text{ADT} \leq 4,000 \text{veh/day, and if the street/road is undivided and unstriped}$$

$$a_1: 0.507 \quad a_2: 0.199 \quad a_3: 7.066 \quad a_4: -0.005 \quad C: 0.760$$

where:

(a1–a4) = coefficients established by the multivariate regression analysis.

The bicycle LOS score resulting from the equation is prestratified into service categories A, B, C, D, E, and F (A being the best and F, the worst), according to the ranges shown in table 4-1 that reflect users' perceptions of the road segments' LOS for bicycle travel. This stratification is conducted in accordance with the linear scale established during the research project that identified bicycle participants' aggregate responses to roadway and traffic stimuli.

Table 4-1. Bicycle level LOS categories.
 Source: Bicycle LOS Software User's Manual⁽⁶⁾

LOS	Bicycle LOS Score
A	≤ 1.5
B	> 5.5
C	> 4.5 and ≤ 5.5
D	> 3.5 and ≤ 4.5
E	> 2.5 and ≤ 3.5
F	> 1.5 and ≤ 2.5

The model is particularly responsive to the factors that are statistically significant. An example of its sensitivity to various roadway and traffic conditions is shown in figure 4-5.

Because the model represents the comfort level of a hypothetical typical bicyclist, some bicyclists may feel more comfortable and others may feel less comfortable than the bicycle LOS calculated for a roadway. A poor bicycle LOS grade does not mean that bicycles should be prohibited from using a roadway.

Application

The bicycle LOS model is used by planners, engineers, and designers throughout the United States and Canada in a variety of planning and design applications. Applications include:

- Conducting a benefits comparison among proposed bikeway/roadway cross-sections.
- Identifying roadway restriping or reconfiguration opportunities to improve bicycling conditions.
- Prioritizing and programming roadway corridors for bicycle improvements.
- Creating bicycle suitability maps.
- Documenting improvements in corridor or system-wide bicycling conditions over time.

Bicycle LOS = $a_1 \ln(\text{Vol}_{15}/\text{Ln}) + a_2 \text{SP}_t(1+10.38\text{HV})^2 + a_3(1/\text{PR}_5)^2 + a_4(W_e)^2 + C$					
where:	a_1 : 0.507	a_2 : 0.199	a_3 : 7.066	a_4 : -0.005	C: 0.760
T-statistics:	(5.689)	(3.844)	(4.902)	(-9.844)	
Baseline inputs:					
ADT =	12,000 vpd	% HV =	1	L =	2 lanes
SP _p =	40 mph	W _e =	12 ft	PR ₅ =	4 (good pavement)
				<u>BLOS</u>	<u>% Change</u>
Baseline BLOS Score (Bicycle LOS)				3.98	N/A
Lane Width and Lane striping changes					
W _t =	10 ft		4.20		6% increase
W _t =	11 ft		4.09		3% increase
W _t =	12 ft	-- (baseline average) -----	3.98	----	no change
W _t =	13 ft		3.85		3% reduction
W _t =	14 ft		3.72		7% reduction
W _t =	15 ft (W ₁ = 3 ft)		3.57 (3.08)		10%(23%) reduction
W _t =	16 ft (W ₁ = 4 ft)		3.42 (2.70)		14%(32%) reduction
W _t =	17 ft (W ₁ = 5 ft)		3.25 (2.28)		18%(43%) reduction
Traffic Volume (ADT) variations					
ADT =	1,000 Very Low		2.75		31% decrease
ADT =	5,000 Low		3.54		11% decrease
ADT =	12,000 Average - (baseline average) --		3.98	-----	no change
ADT =	15,000 High		4.09		3% increase
ADT =	25,000 Very High		4.35		9% increase
Pavement Surface conditions					
PR ₅ =	2 Poor		5.30		33% increase
PR ₅ =	3 Fair		4.32		9% reduction
PR ₅ =	4 -- Good - (baseline average) - - -		3.98	----	no change
PR ₅ =	5 Very Good		3.82		4% reduction
Heavy Vehicles in percentages					
HV =	0 No Volume		3.80		5% decrease
HV =	1 --- Very Low - (baseline average) --		3.98	-----	no change
HV =	2 Low		4.18		5% increase
HV =	5 Moderate		4.88		23% increase _a
HV =	10 High		6.42		61% increase _a
HV =	15 Very High		8.39		111% increase _a

Figure 4-5. Equation. Bicycle LOS sensitivity analysis.

Source: *Bicycle LOS Software User's Manual*⁽⁶⁾

4.7 Mapping

There are four basic types of bicycle maps:

- Urban bicycle facility maps.
- County, State, or regional bicycling guides.
- Bicycling tour guides.
- City or county planning maps.

The first three are used mainly by bicycle riders; the fourth, by a wide variety of interested parties.

Urban Bicycle Map

Used primarily by local utilitarian bicyclists, newcomers, and visitors, this type of map is intended to help cyclists choose routes they feel comfortable riding and to encourage first-time riders to make trips by bicycle (see figure 4-6). All streets should be shown. A simple color code indicates the presence and types of bicycle facilities. It also warns bicyclists of roads they should use with caution. The accompanying text should provide information on traffic laws, safety tips, and the proper use of bikeways.

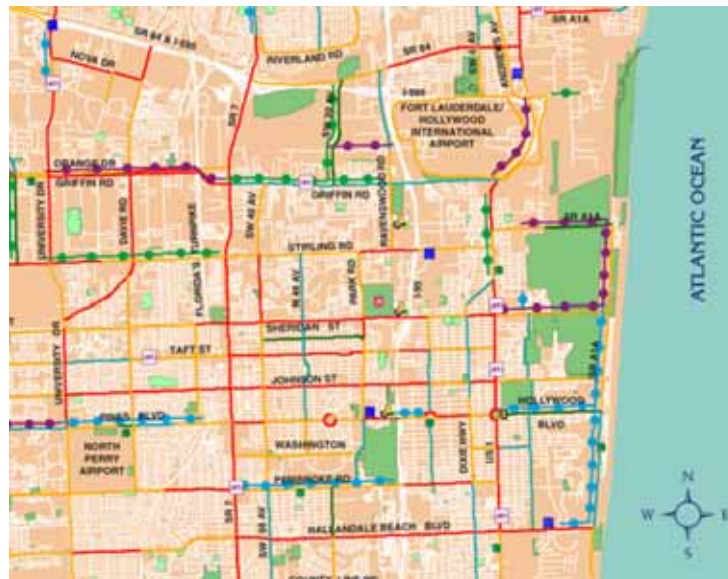

Figure 4-6. Illustration. A bicycle route map provides bicyclists with information about street characteristics by using different color codes.

Source: Broward County Bicycle Suitability Map

Other useful information includes enlargements of difficult intersections, steep hills, weather data, parking facilities, bike shops, important destinations, and landmarks, etc. However, too much detail creates a cluttered effect; simplicity makes it easier to find needed information.

Bicycle Guide

The intended audience is recreational and touring riders interested in medium- to long-distance trips. The major concerns when choosing a route are traffic volume and roadway conditions. Color coding indicates bicycle LOS; a solid line indicates the presence of shoulders wide enough for bicycle travel.

The map should include State highways and county roads. The level of detail is less than that on an urban map. Other information to be included are distances, grades, weather data (especially prevailing wind directions), and camping facilities. Text should be used for information on local history, landmarks, viewpoints, etc.

Description of loop tours is useful to riders planning day trips. Local bicyclists should ride the loops in order to assess conditions. A written description of the route that lists landmarks and turns is helpful. Since bicycle trips often cross jurisdictional boundaries, counties are encouraged to coordinate when creating regional maps that cover natural geographical areas within easy reach of multiple population centers.

Other Useful Tips

Good maps are clear and simple—too many symbols and details create confusion. Only needed information should be included:

- For urban maps, all city streets should be shown, as well as schools, public agencies, and other common destinations. But not every street needs to be labeled for bicycling purposes. Most residential streets and minor collectors function well as shared roadways and can be shown but not labeled on the map.
- For bicycling guides, too much topographical detail obscures useful information.
- For tour guides, inclusion of all roadways in the vicinity creates a confusing, web-like effect. Only the roads on the tour need to be included, along with roads that connect the route to other localities (for riders who wish to join or leave the route at intermediate points). Insets of urban areas are useful.

It is usually better to create a new map. If available graphics capabilities don't allow this, existing maps can be used by adding and deleting information.

Other important considerations include the following:

- Symbols and text should orient in the direction the map will be held (if possible, north at the top).
- Descriptive text should be placed as close as possible to the relevant map segment (especially important for tour guides).

4.8 Student Exercise

Find bicycle and/or pedestrian planning guidelines for your city, county, or State. Also find plans from another region with comparable characteristics. What are the major elements of your local plan? From the plans, what can you determine is important to the area? Compare the two sets of plans and evaluate your plan's strengths and weaknesses.

4.9 References and Additional Resources

The references for this lesson are:

1. *Guide for the Development of Bicycle Facilities*, AASHTO, Washington, DC, 1999.

2. Burden, D. and B. Drake, *Pedestrian and Bicyclist Safety and Accommodation (Participant Workbook)*, FHWA-HI-96-028, National Highway Institute, Arlington, VA, 1996.
3. 1995 Nationwide Personal Transportation Survey, available online at <http://npts.ornl.gov/npts/1995/doc/index.shtml>, accessed August 12, 2005.
4. NHTS, available online at http://www.bts.gov/programs/national_household_travel_survey/, accessed August 12, 2005.
5. *Guidebook on Methods to Estimate Non-Motorized [sic] Travel: Overview of Methods*, FHWA, Publication No. FHWA-RD-98-166, Washington, DC, 1999.
6. *Bicycle LOS Software User's Manual*, Sprinkle Consulting, Inc., Lutz, FL, no date.

Additional resources for this lesson include:

- Landis, Bruce W. et al., “Real-Time Human Perceptions: Toward a Bicycle Level of Service” *Transportation Research Record 1578*, TRB, Washington, DC, 1997.
- *Oregon Bicycle and Pedestrian Plan*, Oregon Department of Transportation, June 1995.
- Pinsof, S. and T. Musser, *Bicycle Facility Planning*, PAS 459, American Planning Association, Chicago, IL, 1995.
- “Policy and Planning Page,” PBIC, Available online at <http://www.bicyclinginfo.org>, accessed April 20, 2004.
- Toole, J., and B. Zimny, “Chapter 16—Bicycle and Pedestrian Facilities,” *Transportation Planning Handbook*, ITE, Washington, DC, 1999.

LESSON 5:

LAND USE REGULATIONS TO ENCOURAGE NONMOTORIZED TRAVEL

5.1 Introduction

Land use and transportation have an extremely complex interrelationship. Often, problems with the transportation system are blamed on faulty land use policies, and problems with sprawling land use are blamed on transportation policies. In fact, the problems typically do not have simple cause-and-effect solutions. This lesson takes a look at ways in which land use regulations can be improved to support an intermodal transportation system that encourages access by walking, bicycling, and transit.

Most communities in the United States have land use regulations that primarily support automobile access to local destinations. Substantial changes to zoning laws and subdivision regulations will be necessary in many communities in order to accomplish fundamental improvements to the transportation system. In addition to ordinances that require bicycle parking and sidewalks, even more basic changes are needed for automobile parking requirements, street design standards, allowable land use densities, and transit-oriented developments.

Revising regulations that have been in place for many years can be a daunting task—either for planners who are trying to remodel a development ordinance or for engineers who are trying to change street design standards to accommodate bicycle and pedestrian travel. This lesson provides some examples of the types of provisions that are included in new policies at the State and local levels in order to accommodate and encourage bicycle and pedestrian travel. The major sections of this lesson are as follows:

- 5.1 Introduction
- 5.2 Pedestrian-Oriented Land Use
- 5.3 Commercial Development Design Guidance
- 5.4 Performance Based Code as a Development (or Redevelopment) Tool
- 5.5 Guidance on Designing Residential Communities That Encourage Walking
- 5.6 Student Exercise
- 5.7 References and Additional Resources

5.2 Pedestrian-Oriented Land Use

One of the most important factors in a person's decision to walk or bike is the proximity of goods and services to homes and workplaces. The most conducive land use for pedestrian activity is one with a higher density mix of housing, offices, and retail (see figure 5-1). Studies have also shown that more people walk in areas that are able to achieve higher densities of either housing or employment, despite lower densities of other uses such as retail. One study of the Puget Sound Region in Washington State defines high density as 50 to 75 employees per acre or 9 to 18 residents per acre.

Zoning and Subdivision Regulations

Pedestrian and bicycle travel is often an afterthought in the development process. The results are impassable barriers to pedestrian travel, both within and between developments. The examples below show how local zoning ordinances can be amended to require more attention to the needs of pedestrians and bicyclists.

Subdivision Layout. A residential subdivision layout (including planned unit developments) should provide safe, convenient, and direct bicycle and pedestrian access to nearby [within 0.4 km (0.25 mi) for walking and 3.2 km (2 mi) for bicycling] and adjacent residential areas, bus stops, and neighborhood activity centers such as schools, parks, commercial and industrial areas, and office parks.



Figure 5-1. Photo. Low-density, single-use zoning creates trip distances that are too great to make walking a viable transportation option.

Cul-de-Sacs. Cul-de-sacs have proven to be effective in restricting automobile through traffic; however, they can also have the effect of restricting bicycle and pedestrian mobility unless public accessways are provided to connect the cul-de-sac with adjacent streets (see figures 5-2 and 5-3). Trail connections between cul-de-sacs and adjacent streets should be provided wherever possible to improve access for bicycles and pedestrians.

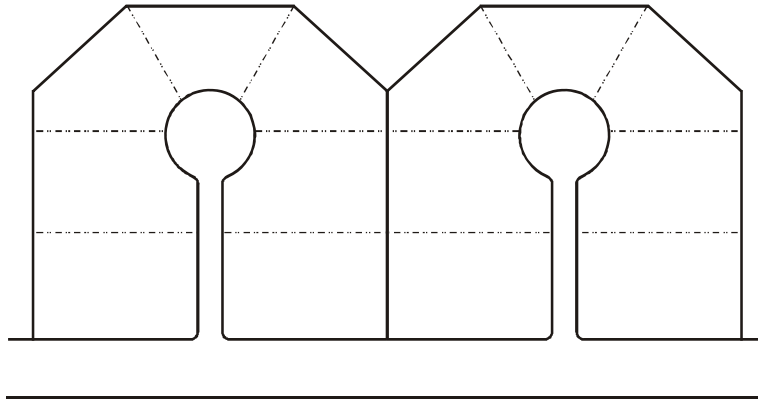

Figure 5-2. Illustration. Cul-de-sacs can restrict pedestrian and bicycle access.

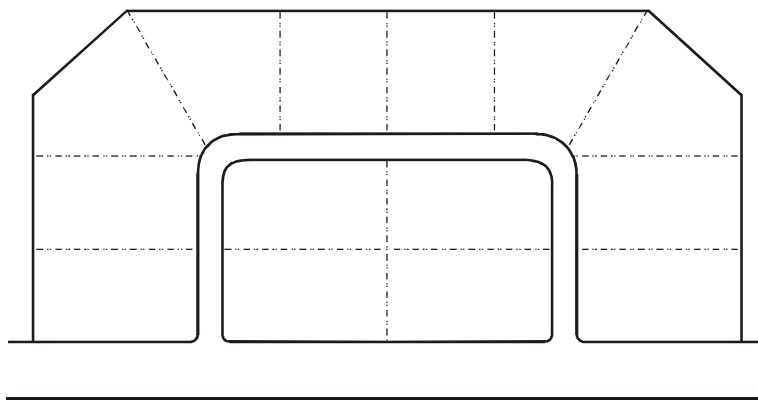

Figure 5-3. Illustration. Loops are preferred to cul-de-sacs.

Future Extension of Streets. During subdivisions of properties, streets, bicycle paths, and sidewalks should be designed to connect to adjacent properties that are also likely to be subdivided in the future, so that a secondary system of roads and sidewalks develops over time. When subdivisions are built with only one outlet to a main thoroughfare, the result is heavy traffic congestion and difficult intersections for both motorists and pedestrians.

Inclusion of Bicycle and Pedestrian Facilities in Piecemeal Development. This is intended to ensure that pedestrian and bicycle facilities are included in projects that occur in a piecemeal fashion. For projects in which only part of the land owned by the applicant is proposed for development, a sketch plan showing the tentative locations of streets, bicycle facilities, and public accessways should be submitted for the entirety of the land owned. Stub-outs (open connections for future development) should be constructed for bicycle and pedestrian facilities onsite, and the next construction phase should be designed to connect to this network.

Internal Bicycle/Pedestrian Circulation for Commercial and Business Developments. Adequate provisions should be made for bicycle and pedestrian circulation between buildings and related uses on development sites. The Americans with Disabilities Act (ADA) also contains regulations for onsite circulation.

Lot Coverage. Zoning codes should be amended to raise the allowable lot coverage along bus routes to encourage intensified and more efficient uses of land in these areas.

Parking in High-Density Residential Developments. In some high-density residential areas, existing regulations require off-street parking and, at the same time, a reduced lot frontage. This results in home fronts that primarily consist of garage doors. Ordinances should be modified to allow for rear-lot access (alleyways) or other innovative solutions in these areas (see figure 5-4).

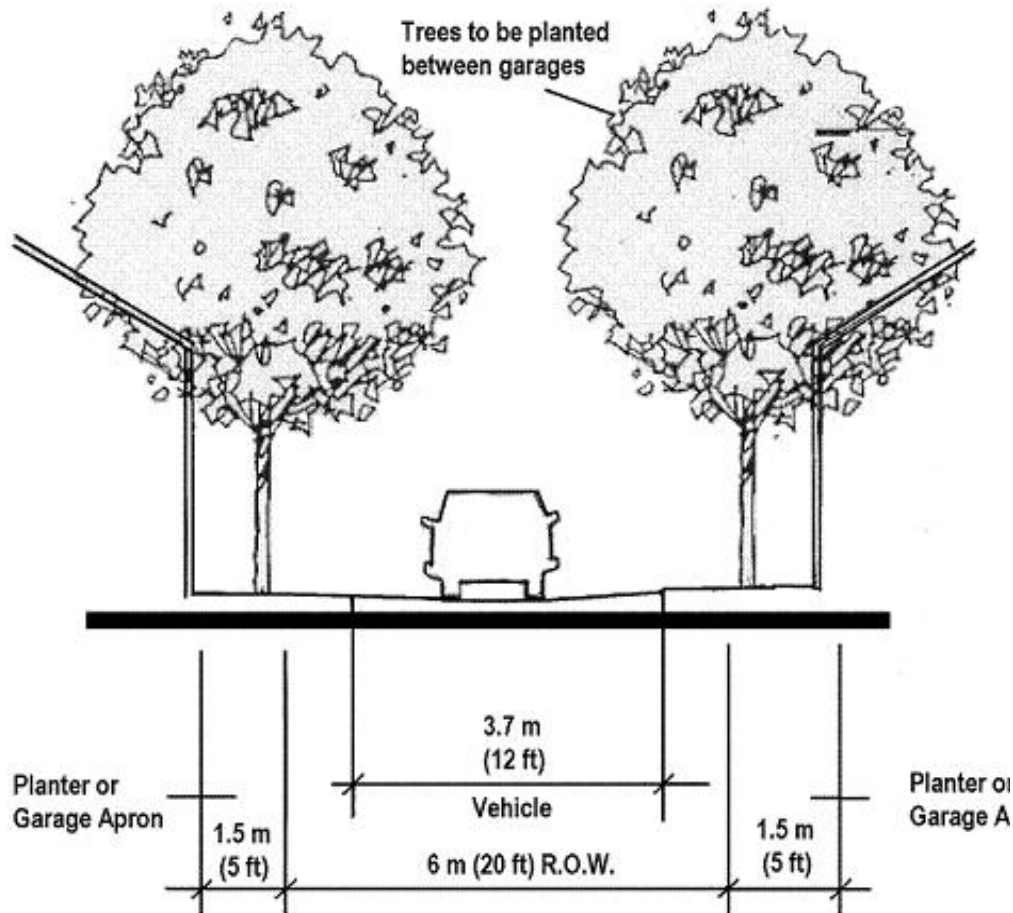

Figure 5-4. Illustration. Typical alley: ordinances should be modified to allow for rear-lot access.

Parking Reductions. Parking codes should be modified to allow a reduced parking option for developments that are located on bus routes and provide facilities that encourage bicycling and walking. In general, shopping center parking lots should not be designed to handle volumes that occur only once or twice per year, but rather more typical volumes.

Compliance with Design Standards. Bicycle and pedestrian facilities should be designed to meet local and statewide design standards.

Community Visioning

Many communities throughout the country are conducting extensive revisions to their zoning and subdivision regulations in light of new planning techniques that improve transportation and community design.

New rules that would allow parking reductions and higher density developments are likely to be controversial. Public education for citizens and elected officials is essential to gain popular support for these new regulations.

The city of Portland, OR, recently conducted an extensive revision of local zoning and subdivision regulations by using a successful technique that encouraged involvement from citizens and local elected officials. The city conducted a well-publicized Visual Preference Survey™ that allowed local citizens to establish a vision of their ideal community environment by comparing photographs of different styles of urban, suburban, and rural development. When shown side-by-side, photographs of suburban strip development were rated far lower than those showing more compact, mixed-use districts.⁽¹⁾

Development Review Process

Land developers should be asked to submit a pedestrian and bicycle mobility plan early during the site plan review process. This plan should provide an inventory of all existing and proposed land uses adjacent to the site, and illustrate a logical circulation plan for pedestrians and bicycles within the development and between adjacent land uses. The questions in table 5-1 below can help design professionals create site plans that are sensitive to the needs of pedestrians.

Table 5-1. Site plan checklist.

<p>Overall System</p> <ul style="list-style-type: none">• Does the plan meet ADA standards?• Are utilitarian paths direct? Do they provide connections to pedestrian magnets nearby? Can pedestrians take advantage of shortcut paths that encourage walking instead of driving?• Does the pedestrian system consider the type and probable location of future development on adjacent or nearby parcels of land? Is there flexibility to provide direct connections to adjacent parcels, should that connection be desired in the future?• Are building entrance areas convenient to the pedestrian? Are they clearly evident through design features, topography, signing, or marking?• Are walkways along the street buffered from traffic as much as possible?
<p>Safety and Security</p> <ul style="list-style-type: none">• Are crossings of wide expanses of parking lots held to a minimum?• Are pathways generally visible from nearby buildings and free from dark, narrow passageways?• Is adequate pedestrian-scale lighting provided for nighttime security?• Are sight lines at intersections adequate for pedestrian visibility? Are pedestrians able to see oncoming traffic, given typical speeds?• Do pathways lead to road crossing points with the least conflict?• In general, are pedestrian/vehicle conflict points kept to a minimum?• Are pedestrians given adequate time to cross the road at intersections?

5.3 Commercial Development Design Guidance

The physical layout of a development can often make the difference in a person's choice to walk between stores or to adjacent developments. Careful attention should be given to the location of buildings as well as the configuration of parking lots. Several provisions can ensure a better walking environment in commercial and office developments.

Building Setbacks. Buildings should not automatically be separated from the street by parking lots—this discourages pedestrian access and primarily serves those who arrive by automobile. A maximum setback requirement of 4.6 to 7.6 m (15 to 25 ft) can help to encourage pedestrian activity. Parking, driving, and maneuvering areas should not be located between the main building entrance and the street. Parking lots should be located on the side and rear yards of the property whenever possible.

For developments with multiple buildings, direct pedestrian access to public transit should be provided by clustering buildings near bus stops.

Building Orientation and Facades. Main building entrances should be oriented to face the street designated as a bus route. Entrances and paved walkways should lead directly to a bus stop. Visual stimulation is very important to pedestrians—long, blank walls with no openings onto the street discourage walking. Building facades should maintain continuity of design elements such as windows, entries, storefronts, roof lines, materials, pedestrian spaces and amenities, and landscaping. Parking garages on streets with bus service should have ground-floor street frontage developed for office, retail, or other pedestrian-oriented uses.

Onsite Walkways. For developments with multiple buildings and/or outparcels, all building entrances on the site should be connected by walkways to encourage walking between buildings and to provide a safe means of travel for pedestrians. Sidewalks between the building edge and parking lots should allow pedestrians safe and convenient access to building entrances without having to walk within driving aisles of parking lots.

Pedestrian Access Between Adjacent Developments. To encourage walking instead of driving between uses on the development site, sidewalks should connect those uses to adjacent activity centers. Barriers such as fences or vegetation should not be placed so as to hinder access between developments.

Lighting. Pedestrian-scale lighting should be designed to light the walkway, thereby increasing pedestrian safety. Pedestrian lighting should be used in addition to lighting provided for motorists' safety. *Time-Saver Standards for Landscape Architecture* includes an excellent chapter on desirable lighting levels for pedestrian facilities, and table 5-2 specifies the following levels of illumination for sidewalks:⁽²⁾

Table 5-2. Levels of illumination for sidewalks.

Location of Lighting	Lux (lx)	Footcandles (fc)
Sidewalks along roadsides:		
Commercial areas	10	0.9
Intermediate areas	6	0.6
Residential areas	2	0.2
Sidewalks distant from roadsides	5	0.5
Pedestrian tunnels	40	4.0

Improvements Between the Building and the Street. Design elements in the area between the building and the street are critical to successful pedestrian spaces. The streetscape should provide visual interest for the pedestrian. The area should be landscaped if project budgets allow.

Parking Lot Design. Parking lots with 50 or more spaces should be divided into separate areas with walkways and landscaped areas in between that are at least 3.0 m (10 ft) in width. Pedestrian paths should be designed with minimal direct contact with traffic. Where pedestrian paths cross the traffic stream, raised speed tables that slow cars while providing an elevated pedestrian walkway should be provided. Additional recommendations for pedestrian-oriented parking lots include:

1. **Location.** Keep parking on one or two sides of the shopping center, away from the side that will generate the most pedestrian access. This pedestrian access point could be an office park, outparcel shopping or restaurant, or a residential area.
2. **Direct Pedestrian Paths.** Provide a direct pedestrian path from parking lots and parking decks to the buildings they serve (see figure 5-5). Clearly delineate this path by striping, using different paving materials, or situating the path through the center of a series of strategically placed parking islands.

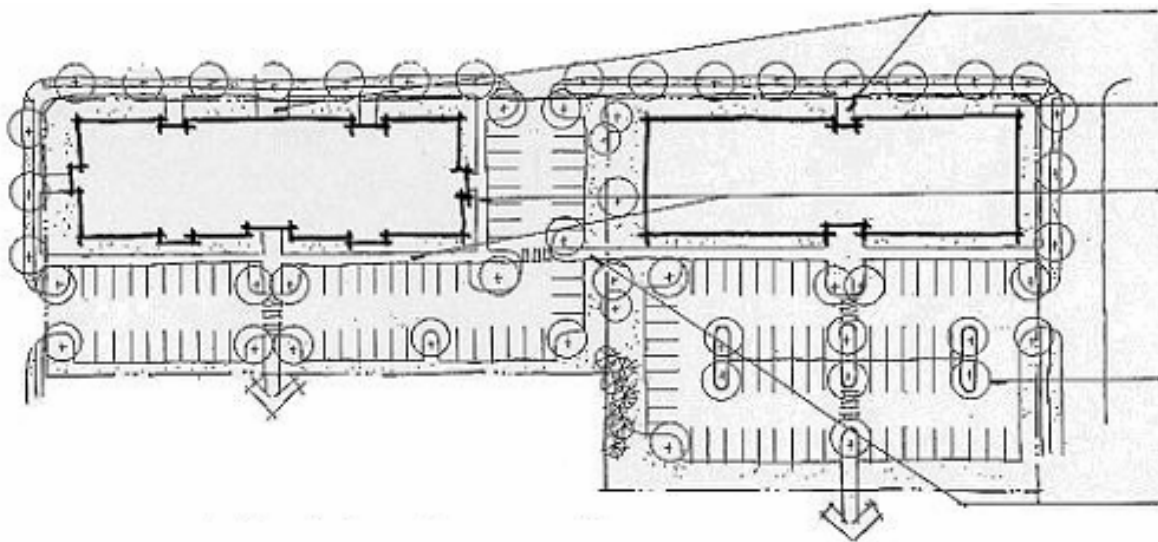

Figure 5-5. Illustration. Provide pedestrian connections between parcels.

3. **Use of Landscaping.** Landscaping can be used to channel and organize the traffic flow in parking lots as well as to provide pedestrian refuge areas. Avoid open parking lots that allow cars to move in any direction.

Bicycle Parking. Provision of bicycle parking at destinations is crucial—without it, bicycling becomes far less convenient. Bicycle parking ordinances can help to improve the situation (see lesson 22 for a full description).

5.4 Performance-Based Code as a Development (or Redevelopment) Tool

Performance or form-based code is a planning technique used to establish desired aesthetics and design standards for a specific location—such as a street corridor that is undergoing redevelopment—to achieve a balanced, pedestrian-friendly environment. In Arlington, VA, form-based code has been used to establish design parameters for Columbia Pike, a five-lane urban arterial that is currently dominated by

motor vehicle traffic and lies within a rapidly redeveloping area. *The Columbia Pike Special Revitalization District Form Based* [sic] *Code* has the following purpose:⁽³⁾

The Form Based Code is a legal document that regulates land development, setting careful and clear controls on building form, with broad parameters on building use, to shape clear public space (good streets, neighborhoods, and parks) with a healthy mix of uses. With proper urban form, a greater integration of building uses is natural and comfortable. The Form Based Code uses simple and clear graphic prescriptions and parameters for: height, siting, and building elements to address the basic necessities for forming good public space.

The *Form Based Code* contains the following elements:

1. **The Regulating Plan.** The regulating plan is the coding key for *The Columbia Pike Special Revitalization District Form Based Code* that provides specific information on permitted development for each building site. The regulating plan also shows how each lot relates to public spaces (streets, civic greens, pedestrian pathways, etc.) and the surrounding neighborhood. There may be additional regulations for lots in special locations/situations identified in the regulating plan.
2. **The Building Envelope Standards.** The building envelope standards establish basic parameters governing building form, including the envelope for building placement (in three dimensions) and certain permitted/required building elements such as balconies and street walls. The building envelope standards establish the boundaries within which things may be done and specific things that must be done. The applicable standard for a building is determined by its street frontage contained in the regulating plan. This produces a coherent street and allows the building greater latitude behind its street facade. The intent of the building envelope standards is to shape a vital public space (Columbia Pike and its adjoining streets) through placement and envelope controls on private buildings. These standards aim for the minimum level of control necessary to meet that goal.
3. **The Architectural and Streetscape Standards.** The goal of the architectural standards is a coherent and pleasing architectural character that complements the best local traditions. The architectural standards govern a building's architectural elements regardless of its building envelope standard and set the parameters for allowable materials, configurations, and construction techniques. Equivalent products or better (as determined by the administrative review team) than those specified are always encouraged and may be submitted for approval to the county.

The purpose of the streetscape standards is to ensure coherent streets and to assist builders and owners with understanding the relationship between the public space of the pike and their own building. These standards set the parameters for planting trees and other amenities on or near each building site.

For more information on performance-based codes, refer to the resources at the end of this lesson.

5.5 Guidance on Designing Residential Communities That Encourage Walking

Suburban neighborhood design can be modified to encourage bicycling and walking. It is not necessarily more expensive to build such communities; however, they require more careful design on the part of the

developer. These types of pedestrian-friendly neighborhoods are worth the effort. Recent studies suggest that homes sell quickly in these communities. (See lesson 6 for a more complete description of traditional neighborhood development.)

A pedestrian-oriented neighborhood should include the following aspects (the list below is taken from the *ITE Journal* article titled “Neo-Traditional Neighborhood Design and Its Implications for Traffic Engineering”):⁽⁴⁾

1. Streets that are laid out in well-connected patterns on a pedestrian scale so that there are alternative automobile and pedestrian routes to every destination. A cul-de-sac pattern generally limits connectivity and is therefore discouraged.
2. A well-designed street environment that encourages intermodal transportation. These streets should include pedestrian-scale lighting, trees, sidewalks, and buildings that are within close walking distance to the sidewalk.
3. Residential and internal commercial streets should be relatively narrow in order to discourage high-speed automobile traffic.
4. On-street parallel parking is recommended where it can be used as a buffer between pedestrians and motor traffic. Parked cars also serve to slow down the passing traffic, helping to balance the overall use of the street.
5. Bicycles are considered an integral part of the transportation mode mix, and the design of the streets includes appropriate facilities for them.
6. The buildings are generally limited in size, and building uses are often interspersed—that is, small houses, large houses, outbuildings, small apartment buildings, corner stores, restaurants, and offices are compatible in size and are placed in close proximity.
7. In addition to streets, there are public open spaces, around which are larger shops and offices, as well as apartments.
8. Larger communities should provide a neighborhood center (providing small-scale commercial and office uses) within a 5-minute walking distance (roughly a 0.40 m (0.25 mi) radius) for the majority of residents in the neighborhood.

5.6 Student Exercise

Zoning and subdivision regulations often pose a significant barrier to implementing the design features discussed in this lesson. While some land development regulations have been revised to encourage the construction of multimodal neighborhoods and commercial areas, unforeseen complications often get in the way of achieving the livable community that was envisioned. The purpose of this lesson is to learn more about the development process and the reasons behind final outcomes in the built environment.

- a) Select a development in your community that was built in the last 2 years. Using the principles described in this lesson, prepare a critique that describes how well the development supports walking and bicycling, as well as automobile travel. Are densities and mixes of uses sufficient to encourage walking trips? Are streets and pathways designed to accommodate and encourage walking and bicycling? Are commercial areas oriented to people arriving in automobiles, or to people arriving on foot?

- b) Review the land development regulations that were in place when this development was built. Interview a local planner to find out the circumstances that led to any deficiencies in the design—often local county planners are well aware of better designs, but are unable to require developers to implement them. How did elected officials influence the process?

Prepare a paper (five pages or less) that summarizes your research and provides conclusions that explain the reasons why desirable—and undesirable—features of the development occurred.

A few tips: Avoid selecting a development that is not yet completed, since some pedestrian and bicycle features are sometimes built later in the development process (such as shared-use path networks). When calling the local planning department of the jurisdiction responsible for the project, ask to speak with one of the planners who was responsible for working with the developer.

For extra credit, speak with the developer of the property, and ask his/her perspective about aspects of the development that were successful and unsuccessful in his/her opinion, particularly in accommodating pedestrians and bicyclists.

5.7 References and Additional Resources

The references for this lesson are:

1. *Picture This. . . The Results of Visual Preference Survey*, A. Nelessen & Associates, Princeton, NJ, and Seattle, WA, 1993.
2. Harris, C.W., and N.T. Dines, *Time-Saver Standards for Landscape Architecture*, McGraw-Hill, New York, NY, 1988.
3. *The Columbia Pike Special Revitalization District Form Based Code*, Arlington County, VA, 2003. Available online at <http://www.arlingtonva.us/Departments/CPHD/forums/columbia/current/CPHDForumsColumbiaCurrentCurrentStatus.aspx>.
4. “Neo-Traditional Neighborhood Design and its Implications for Traffic Engineering,” *ITE Journal*, vol. 62, no. 1, January 1992, pp. 17–18.

Additional resources for this lesson include:

- Models and Guidelines for Managing Maryland’s Growth—Modeling Future Development on the Design Characteristics of Maryland’s Traditional Settlements, Maryland Office of Planning, 1994.
- Oregon Transportation Planning Rule, American Planning Association, Washington, DC, 1993.
- Urban Planning Tools for Quality Growth—First Edition and 2002 Supplement, Envision Utah, 2002. Available online at <http://envisionutah.org/Introduction.pdf>.
- U.S. Department of Energy's Smart Communities Network, <http://www.sustainable.doe.gov/welcome.shtml>, accessed March 21, 2005.

LESSON 6:

TRADITIONAL NEIGHBORHOOD DESIGN

6.1 Introduction

Traditional neighborhood design (TND) (also called new urbanism or neotraditional design) is a town planning principle that is gaining acceptance in recent years as part of the solution to a variety of problems in suburban communities throughout the country. Traditional neighborhoods are more compact communities designed to encourage bicycling and walking for short trips by providing destinations close to home and work, and by providing sidewalks and a pleasant environment for walking and biking. These neighborhoods are reminiscent of 18th and 19th century American and European towns, along with modern considerations for the automobile.

The major sections of this lesson are as follows:

- 6.1 Introduction
- 6.2 The New Urbanism Debate
- 6.3 “Putting the Brakes on Suburban Sprawl”
- 6.4 Street Design for Traditional Neighborhoods
- 6.5 Student Exercise
- 6.6 References and Additional Resources

This lesson has been primarily derived from two sources: a 1994 article in *Engineering News-Record* on traditional neighborhood design, and the *Neo-Traditional Street Design Handbook* from ITE. Additional sources of information are listed at the end of the lesson.

6.2 The New Urbanism Debate

While new urbanism has been a positive influence on the field of planning and engineering, it has also been a source of considerable debate. Hundreds of new urbanist developments have been built throughout the country. Yet many have not achieved some of the more lofty goals of their founders, who hoped that families living in new urbanist communities would own fewer cars and make most of their daily trips on foot.

New urbanist neighborhoods are often built as an alternative to the sprawling style of suburban development. While traditional neighborhoods offer a better alternative to the single use, monocultural suburban neighborhood that was ubiquitous in the past, they are sometimes built on open land on the urban fringes many miles from the urban center and surrounded by high-volume arterial roadways. Another criticism has been that housing in these new traditional neighborhoods is often beyond the price range of lower- to middle-income families. These neighborhoods become enclaves of good design; however, they do not solve transportation problems because their residents still drive to most destinations.

New urbanism has been one of the hottest new planning theories among the modern generation of planners. It is appealing to start with a clean slate in a new development and build well the first time. However, a great deal of work lies ahead to redesign standard suburban standard suburban neighborhoods and streets in the United States to be more conducive for nonmotorized use. The task of retrofitting

existing suburban and urban communities to accommodate and encourage walking and bicycling is a daunting challenge.

For other perspectives in the debate on new urbanist design principles and goals, see the references at the end of this lesson.

The planning profession continues to strive towards development principles that result in fewer automobile trips and more walking trips, and the failures of the new urbanist movement are as instructive as the successes. This lesson strives to address both topics, and begins with a article that appeared in the May 1994 edition of *Engineering News-Record*.⁽¹⁾ It is written from an engineering perspective, and provides a historical backdrop of the issues that were debated during the mid 1990s, at the initial outset of a movement that has now reached nearly every corner of the U.S.

6.3 “Putting Brakes on Suburban Sprawl”

The following article, “Putting Brakes on Suburban Sprawl,” is reprinted with permission from *Engineering News Record (ENR)*, May 1994. Readers should note that the terms used in this article—new urbanism, neotraditional design, traditional neighborhood design—are considered interchangeable, as they are in the rest of this lesson and this entire course.

New urbanists are zealots. They proselytize their antidote to alienation—new old-style towns—with a missionary’s fervor. And after a frustrating first decade bucking an automobile-driven society unfriendly to their peripatetic ways, they are beginning to make great strides.

With several neotraditional neighborhoods built, public planners are taking notice. Some are even adjusting general plans and zoning for compact walkable mixed-use towns. Suburban traffic engineers and public works officials are no longer simply recoiling at the prospect of pedestrian-friendly street patterns with narrower, gridded, and tree-lined streets. And market surveys are convincing skeptics that suburban residents are content living in a town that by design nurtures both community consciousness and the individual spirit.

“Contemporary suburbanism isolates and separates [see figure 6-1],” says Paul Murrain, an urban planner based in Oxford, U.K. Consumers are recognizing “in their hearts” the better quality of life offered by new urbanism, he adds.

Though new urbanism is also intended for cities cut to pieces by highways, it is more the planner’s answer to suburban sprawl and the breakdown of community caused by a post-World War II obsession with the automobile. Apart from nearly total dependence on the car, the typical suburb, with its looping or dendritic street pattern and dead-end cul-de-sacs, “is laid out so that it can’t grow,” says Andres Duany, partner in Andres Duany & Elizabeth Plater-Zyberk Architects and Planners (DPZ), Miami. “It chokes on itself in very short order.”

“Suburban sprawl is riddled with flaws,” Duany continues. Unfortunately, “all of the professions [involved in development] have sprawl as their model.”



Figure 6-1. Illustration. New urbanism allows travel from one destination to another without using collector roads.

Source: Illustration and caption by *ENR*, May 9, 1994⁽¹⁾

Even those who do not subscribe to new urbanism see a need for change. “We are finally recognizing we should plan communities, not structures,” says Carolyn Dekle, executive director of the South Florida Regional Planning Council, Hollywood.

“New urbanism is a return to romantic ideas of the past and does not respond to current lifestyles,” says Barry Berkus, principal of two California firms, B3 Architects, Santa Barbara, and EBG Architects, Irvine. “But it is part of a knee-jerk, but needed, reaction to irresponsible planning that produced monolithic neighborhoods without character.”

Duany, both charismatic and outspoken, and his cerebral wife Plater-Zyberk are in new urbanism’s high priesthood. To focus attention on their goals, DPZ and several others created the Congress for the New Urbanism last year. The second meeting is set for May 20 to 23 in Los Angeles. “We need all the converts we can get,” says Duany, because, “inadvertently, one thing after another prevents it.” Among these are fear of change and criticism that the new urbanism model is too rigid—robbing the individual residents of choice.

Regardless of criticism, converts are beginning to spill out of the woodwork. “Before my conversion, I was a schlock developer,” confesses John A. Clark, of the Washington, DC, company that bears his name. “Most of my stuff was so bad it makes your teeth ache.”

Then in 1988, after reading about neotraditional development, the movement's original name, "the light bulb went off," says Clark. He called Duany and soon enlisted DPZ in the campaign for Virginia's Haymount.

There are other tales of conversion. "We were Duanied," says Karen Gavrilovic, principal planner in the Loudoun County Planning Dept., Leesburg, VA. Last year, the county adopted a comprehensive general plan based on new urbanism, which just won an American Planning Association award.

Until new urbanism becomes mainstream, the approvals process for each community tends to be tortuous and therefore expensive. "The thing that must change is the cost of establishing new communities," says Daniel L. Slone, a lawyer with Haymount's counsel, McGuire Woods Battle & Boothe, Richmond. "It will take the cooperation and leadership of planners, politicians, and environmental and social activists."

Approvals are complicated. The approach "raises hundreds of land-use questions" that must be answered, says Michael A. Finchum, who as Caroline County's director of planning and community development, Bowling Green, VA, is involved with Haymount.

"Anything new is of concern," especially to lenders and marketers, agrees Douglas J. Gardner, project manager for developer McGuire Thomas Partners' Playa Vista, a new urbanism infill plan sited at an old airstrip in Los Angeles (*ENR*, 10/04/93, p. 21). But Gardner sees planning obstacles as surmountable and blames Playa Vista's 5-year approval time on a trend toward a "more rigorous regulatory framework" for all types of developments.

Fabric

New urbanism combines aspects of 18th and 19th century American and European towns with modern considerations, including the car. As in Loudoun County, the model can be applied on any scale—to a city, a village, or even a hamlet. In West Palm Beach, FL, which is drafting a new urbanist downtown plan, it is superimposed on an existing urban fabric. Though most of the architecture so far has been traditional, any vernacular is possible.

Like a bubble diagram, neighborhoods should overlap at their edges to form larger developed areas, interconnected by streets, public transit, and bicycle and footpaths. Regional mass transit and superhighways enable workers to commute to remote job centers.

To make new urbanism work on a wider scale, San Francisco-based Calthorpe Associates promotes urban growth boundaries and future development around regional transit. But localities are afraid they will lose control, so most States have not authorized regional governance, says Peter A. Calthorpe. The result is "fractured development, no regional transit, and no attention to broader environmental and economic issues," he says.

There are many proposed new urbanism projects, but less than a dozen are built. Most, not yet 5 years old, have yet to reach build-out. The more well known are DPZ's Kentlands in Gaithersburg, MD; architect-planner Calthorpe's Laguna West in Sacramento; architect Looney [R]icks Kiss' Harbor Town in Memphis; and DPZ's Seaside, a northern Florida vacation-home town.

Retrofits are possible, but more difficult [see figure 6-2]. Subdivisions, with multiple landowners and streets that are nearly impossible to link, are the most troublesome. Office park and shopping center makeovers, such as Mashpee Commons on Cape Cod, are easier because the cost of a parking garage to free up surface lot space for development can often be financially justified, says Duany.

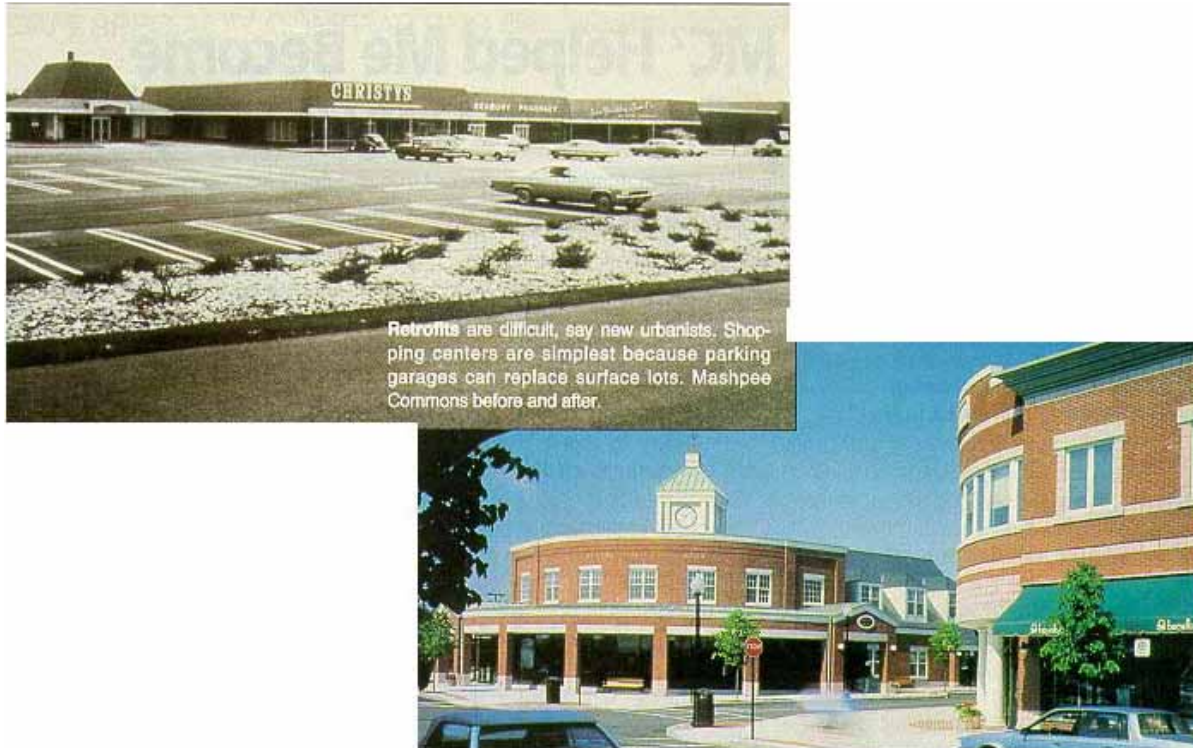

Figure 6-2. Photos. Mashpee Commons before and after retrofitting.

Source: Photos and caption by *ENR*, May 9, 1994⁽¹⁾

The optimal new urbanism unit is 160 acres. Typically, the developer provides the infrastructure. The town architect establishes and oversees the plan and designs some structures. But other architects are also involved. Public buildings and space, including a community green, are located near the center, as are many commercial buildings.

Mix

Under new urbanism, there is often no minimum building setback. Lot widths are typically multiples of 4.9 m (16 ft), and are 30.5 m (100 ft) deep. There are a variety of residential buildings—apartment buildings, row houses, and detached houses—usually mixed with businesses. Finally, there are alleys lined by garages and secondary buildings, such as carriage houses and studios.

All elements are planned around “the distance the average person will walk before thinking about getting in the car,” says Michael D. Watkins, Kentlands’ town architect in DPZ’s Gaithersburg [MD] office. That is a maximum 5-minute walk—a quarter mile or 1,350 ft [0.4 km or 411 m]—from a town center to its edges.

New urbanists maintain that a family will need fewer cars. Duany likes to point out that it costs an average of \$5,500 per year to support each car, the equivalent of the annual payment on a \$55,000 mortgage.

Sidewalks are usually 1.5 m (5 ft) wide instead of 1.2 m (4 ft). Streets, designed to entice, not intimidate, walkers, are typically laid out in a hierarchical, modified grid pattern. The broadest are 11.0 m (36 ft) wide; the narrowest, 6.1 m (20 ft). On-street parking is encouraged and counted toward minimum requirements [see table 6-1]. Vehicle speed is 24.1 to 32.2 kilometers per hour (km/h) [15 to 20 miles per hour (mi/h)], not 40.2 to 48.3 km/h (25 to 30 mi/h). Curb return radii are minimized so that a pedestrian crossing is not daunting. Superhighways are relegated to the far outskirts of town.

In a grid, traffic is designed to move more slowly, but it is also more evenly distributed so there are fewer and shorter duration jams, says Duany. In the typical suburb, broad commercial streets, called collectors, have become wall-to-wall traffic, while loop and cul-de-sac asphalt typically remains underused.

Table 6-1. Comparison of new urbanism versus standard street design practices.

Source: *ENR*, May 9, 1994⁽¹⁾

Street Design	Standard	New Urbanism
Basic layout	Dendritic	Interconnected grid
Alleys	Often discouraged	Encouraged
Design speed	Typically 40–48 km/h (25–30mi/h)	Typically 32 km/h (20 mi/h)
Street width	Generally wider	Generally narrower
Curb radii	Selected to ensure in-lane turning	Selected for pedestrian crossing times and vehicle types
Intersection geometry	Designed for efficiency, safety, vehicular speed	Designed to discourage through traffic, for safety
Trees, landscaping	Strictly controlled	Encouraged
Street lights	Fewer, tall, efficient luminaries	More, shorter, closely spaced lamps
Sidewalks	1.2 m (4 ft) minimum width, outside right-of-way to undulate	1.5 m (5 ft) minimum, with right-of-way and parallel to street
Building setbacks	4.5 m (15 ft) or more	No minimum
Parking	Off-street preferred	On-street encouraged
Trip generation	Developed from a sum of the users	Developed from a reduced need for vehicular trips

Berkus objects to the grid, except to organize the town center. The “edges should be organic” for those who perceive “enclaves” as safer and more secure places to live, he says.

Bernardo Fort-Brescia, principal of the Miami-based Arquitectonica, also thinks the undulating street and cul-de-sac should be offered. “There are no absolutes,” he says.

The firm’s plan for Meerhoven, a new town proposed for Holland, reflects many new urbanist concepts in a modern vernacular. “Nothing is faked to appear old,” says Fort-Brescia. Every element has a function based on modern lifestyles. For example, the town lake is sized for triathlon swimming and perimeter marathon runs. But pedestrians and bikers are encouraged. And mass transit will whisk commuters to jobs elsewhere.

Arquitectonica is fortunate—there are no intractable standards in the way of its plan. But in the United States, new urbanists say their biggest roadblocks are existing street design standards geared to traffic volume and efficient movement, and zoning that prohibits small lots and mixing building types. For example, firefighters and sanitation officials want to have a street wide enough for trucks to turn corners without crossing the centerline.

“Public works will view your proposal with suspicion” because in new urbanism, traffic is no longer the driving force behind street design, says Frank Spielberg, president of traffic engineer SG Associates Inc., Annandale, VA.

Spielberg, sympathetic to new urbanism, but cautious about traffic issues, says there are still questions: Lower expected traffic volume justifies narrow streets, but is actual traffic volume lower? How long would it take to convince residents they need fewer cars? Will traffic be retained within the project, which would relieve the developer of adjacent road upgrades?

Traffic engineers have been working for 40 years to accommodate the proposals of architects and planners, maintains Spielberg, chairman of the Washington-based ITE’s 5-year-old committee on traffic engineering for neotraditional development. Now that the approach is changing, “traffic engineers will respond,” he says.

Reform

“Surprisingly, traffic engineers, the most recalcitrant of all, are the first to reform,” agrees Duany. ITE plans to publish neotraditional street design guidelines late this year or early in 1995.

In addition to ITE’s manual, which already contains residential street guidelines, there are AASHTO standards. They support compact projects, “but only if you already know where to look,” says C.E. Chellman, CEO of White Mountain Survey Co., a land surveyor-engineer in Ossipee, NH, and editor of ITE’s draft guidelines.

Chellman says transportation officials often forget that ITE and AASHTO standards are not binding codes. Officials are reluctant to use judgment, he says.

Some engineers simply take issue with the specifics driving new urbanism. Skokie, IL-based traffic engineer Paul C. Box, who wrote the existing ITE residential street guidelines, claims lowering the speed limit is against human nature. He says on-street parking is dangerous because children get hit running out between parked cars. He is against narrower through streets and the bicycle as transportation unless separate bike paths or lanes are constructed, which he says is too costly. He also thinks undulating sidewalks are safer than those along the street.

Until there is a body of research to support it, mainstream lenders and commercial interests will continue to shy away from new urbanism, says James Constantine, principal of Community Planning Research Inc., Princeton, NJ. In February, Constantine released data from a survey of “active” home-buyers [sic] attending the Home Builders Association of Memphis show at Harbor Town last September. Of 123, “a whopping two-thirds” said they’d “like” to live in a neotraditional neighborhood, he says. The only market resistance was to small lots and minimal setbacks, he adds.

John H. Schleimer, president of Market Perspectives, [Roseville], CA, says even home buyers surveyed recently who bought elsewhere “like” the idea of community and the option of walking places. But many said they paid the same price for bigger homes on larger lots.

Haymount’s Clark isn’t rattled: “Someone who wants to live on a mansion-size lot and ‘commit cul-de-side’ has to go elsewhere. That’s why there is vanilla and chocolate.”

By Nadine M. Post

6.4 Street Design for Traditional Neighborhoods

Traditional neighborhoods have begun to appeal to both community designers and home buyers alike. It is important, however, to consider that traditional street design fundamentally differs from standard suburban street design. In recent years, many developers have claimed that their projects are new urbanist, but are in fact missing critical features. This section provides more specific details on traditional street design, and explains how it is different from standard suburban street design.

Basic Street Layout

Standard suburban street design is characterized by a hierarchical, tree-like pattern that proceeds from cul-de-sacs and local streets to collectors to wide arterials. The organization of the network collects and channels trips to higher capacity facilities. The use of streets in residential areas for intercommunity and through traffic is minimized by limiting access by constructing few perimeter intersections, reducing interconnections between streets, and by using curving streets and cul-de-sacs in the development. Where this layout is successfully designed and constructed, automobiles are the most convenient choice for short, as well as long, trips. The street layout forces longer, less direct auto travel when street connections are missing.

The hierarchical street layout reflects the guiding principle that streets on which residences front should serve the least traffic possible. At best, only vehicles traveling to or from the homes on a given street would ever appear on that street. There would be little or no through traffic, hence the prevalence of cul-de-sacs (see figure 6-3). Traffic from residential streets is quickly channeled through the street hierarchy to collectors and then to arterials. Only arterials, fronted primarily by stores, offices, or apartments, provide direct connectivity between land uses and other neighborhoods.

By contrast, TND calls for an interconnected network of streets and sidewalks to disperse vehicular trips and to make human-powered modes of travel (such as walking and biking) practical, safe, and attractive for short trips. Motorists, pedestrians, and public officials will find the regular pattern more understandable.

A TND street pattern can also have a hierarchy, with some roadways designed to carry greater traffic volumes. A basic assumption of new urbanist planning, however, is that neighborhood streets that serve local residential trips can also safely serve other neighborhood trips and some through traffic. For example, a street with 40 homes would need to carry about 20 vehicle trips during the peak hour. The effective capacity of this street could easily be 200 vehicles per hour without a significant effect on safety or environmental quality. By limiting the access to the street as in standard suburban design, 90 percent of its effective capacity is wasted. Nearby arterials must make up the difference.



Figure 6-3. Photo. Typical suburban neighborhoods offer few route choices for trips.

By eliminating dead ends and designing all streets to be interconnected, neotraditional neighborhoods provide multiple route choices for trips. By using narrow streets and by constructing more of them, more, yet smaller, intersections are created. In concept, therefore, overall network capacity is increased, traffic is dispersed, and congestion is reduced in neotraditional communities. While this rationale seems intuitively correct, it must be carefully applied. Land use and density are not constant across a neotraditional community. Larger traffic generators will attract larger numbers of vehicles that may require multilane streets and intersections.

Use of Alleys

Planners discourage alleys in standard suburban residential areas. In a typical suburban development, an alley behind homes serves no function because garages and their driveways are accessed from the street.

However, in TND, alleys give neighborhood planners design flexibility by permitting narrow lots with fewer driveways on local streets. Fewer driveways also mean more affordable, smaller home sites and more space for on-street parking, especially if the home-owners use the alleys for their own vehicular access, parking, and utilitarian activities. Alleys provide space for underground or unattractive overhead utilities while freeing streets for trees and other plantings. Alleys also can be used for trash storage and collection and emergency vehicle access. TND projects do not have alleys everywhere, but where they do, traffic safety may improve. Alleys eliminate residential driveways and the need for backing up onto the street, which would otherwise occur and is inherently unsafe.

Street Design Speed

Design speeds for standard suburban neighborhood streets range from a minimum of 40.2 or 48.3 km/h (25 or 30 mi/h) to 72.4 km/h (45 mi/h). The design speed recognizes the type of facility (local, collector, or arterial), and it allows for a standard 8.0 or 16.1 km/h (5 or 10 mi/h) margin of safety above the 85th

percentile speed, which is usually the posted speed. Often, the signing of wide streets for 40.2 to 56.3 km/h (25 to 35 mi/h) simply results in more speed violations. It is not unusual for neighbors to complain of speeding traffic on neighborhood streets and to request actions to slow the traffic. Stop signs, speed bumps, “Children at Play” signs, and the like might have to be used to slow vehicles from the original design speed of the street.

New urbanism projects attempt to control vehicle speeds through careful design of streets and the streetscape. Minimum TND street design speeds are 24.1 to 32.2 km/h (15 to 20 mi/h). On-street parking, narrow street widths, and special design treatments help induce drivers to stay within the speed limits. T-intersections, interesting routes with lots of pedestrian activity, variable cross section designs, rotaries, landscaped medians, curb extensions, and other treatments may be used.

At slower speeds, the frequency of vehicular crashes may decline, and those that do occur may be less severe. What is not clear is whether or not the frequency of pedestrian-vehicle crashes also decreases with speed. Pedestrian crash types are often associated with darting out from between parked cars, walking along roadways, crossing multilane intersections, crossing turn lanes, dashing across intersections, backing vehicles, ice cream vending trucks, and bus stops.

For new urbanism projects, the goal is to create more active streetscapes involving more of the factors that slow drivers. These include parked cars; narrow street width; and eye contact between pedestrians, bicyclists, and drivers. The overall impact of these elements of design is enhancement of the mutual awareness of drivers and pedestrians. Thus, many professionals believe that in a traditional neighborhood, drivers are more likely to expect pedestrians and avoid them in emergency situations.

Street Width

In standard suburban neighborhoods, street type, width, and design speed are based on projected vehicle volumes and types. The larger the vehicle permitted on the street according to local regulations, the wider the street. The focus is on motorized vehicles, often to the exclusion of pedestrians, other transportation modes such as bicycles, and other considerations of the community environment.

Ideal suburban lane widths per direction are 3.7 m (12 ft), while exclusive turn lanes may be 3.0 m (10 ft) or less. Depending on whether or not parking is permitted, two-lane local street widths vary from 6.7 to 11.0 m (22 to 36 ft), while two-lane collector streets vary from 11.0 to 12.2 m (36 to 40 ft). In many suburban jurisdictions, the minimum street width must accommodate cars parked on both sides, an emergency vehicle with its outriggers, and one open travel lane. These possible uses instead of reasonably expected uses lead to a worst-case design scenario, an excessively wide street, and probable higher travel speeds.

In contrast to standard street design, the width of TND streets is determined by the projected volumes and types of all the users of the street, including pedestrians. The actual users of the street and their frequency of use help determine street width. In addition, TND-type standards come into play. The basic residential TND street has two lanes, one for each direction, and space for parking on at least one side. The resulting minimum width may be as narrow as 8.5 to 9.1 m (28 to 30 ft). Design considerations, however, may preclude parking in some areas, perhaps to provide space for bicyclists.

If traditional communities encourage narrower streets with parking, then vehicles will naturally slow and stop for parking maneuvers and for larger approaching or turning vehicles that may encroach on the other lane. The TND concept is that drivers must be more watchful (as they usually are in central business districts) and, once more watchful, drivers expect to and do stop more frequently.

To alert drivers to the relative change in importance between vehicles and pedestrians, they must be warned at entrances to the TND street pattern. This warning must be more than signs. Narrower streets, buildings closer to the street, parked cars, smaller signs, and the generally smaller, much greater visual detail of a pedestrian-scale streetscape all serve as good notice to the visitor.

Curb Radii

Curb radii in suburban neighborhoods match expected vehicle type, turning radius, and speed to help ensure in-lane turning movements if possible. In order to accommodate the right-hand turning movements of a tractor trailer and larger vehicles, no matter what their frequency of street use, suburban streets typically have minimum intersection curb radii of 7.6 to 10.7 m (25 to 35 ft). Some jurisdictions require 15.2 m (50 ft) or more. What such large curb radii do for smaller, more predominant vehicles is to encourage rolling stops and higher turning speeds. These conditions increase the hazards for crossing pedestrians. The large curb radii effectively increase the width of the street, the pedestrian crossing time, and the exposure of pedestrians to vehicles.

TND curb radii are usually in the range of 3.0 to 4.9 m (10 to 15 ft). They depend on the types of vehicles that most often use the street, not the largest expected vehicle. The impacts on pedestrians, parking spaces, and turning space for larger vehicles are also considered. The smaller the curb radii, the less exposure a crossing pedestrian has. Furthermore, an additional parking space or two may extend toward the intersection with small curb radii, or if parking is prohibited, additional room for turning vehicles is created.

Intersection Geometry

Many manuals detail standard intersection design and analysis for suburban developments.⁽²⁾ Such intersections are designed for an environment in which the automobile is dominant. Hence, traffic engineers attempt to maximize intersection capacity, vehicle speed, and safety. They also aim to minimize vehicle delay and construction cost. As a result of the hierarchical approach to street system design, which carries traffic from narrow local streets to larger collectors and arterials, intersection size and complexity grow with the streets they serve. Drivers of these streets expect an ordered structure, and any anomalous designs present safety problems.

In TND, the concept of connected patterns of narrow, well-designed streets is intended to improve community access in spite of low design speeds. The numerous streets provide more route choices to destinations and tend to disperse traffic. In concept, the more numerous, smaller streets also mean smaller, more numerous, less congested intersections. Again, due to slower vehicular speeds, greater driver awareness, and the desire for vista terminations, some TND intersection designs are typically different from standard suburban designs.

Street Trees and Landscaping

Subdivision standards and roadway design practice strictly control the size and location of street trees and other plantings. Some local regulations may even prohibit trees and other plantings near the street. These guidelines originated with the precedent of the forgiving roadway that arose through tort actions. They generally place trees far from the edge of high-speed roads to reduce the chance of serious crashes if vehicles swerve off the road. For suburban streets with lower design speeds and space for parked cars, trees can be closer to the street.

Trees and landscaping form an essential element of the streetscape in TND projects (see figure 6-4). The relationship of vertical height to horizontal width of the street is an important part of creating a properly

configured space or outdoor room. On some streets that feature single family housing, the design may call for setting the houses back somewhat from the street. In neighborhoods and along streets such as this, the trees form an important part of that street. While providing shade and lowering street and sidewalk temperatures, they create a sense of closure in a vertical plane. Along streets that contain townhouses and stores with apartments above them, actual full-sized trees become less important, while smaller trees and landscaping remain essential elements.



Figure 6-4. Photo. Neotraditional neighborhoods have narrower, tree-lined streets.

Street Lighting

Typical suburban neighborhood design calls for large, efficient luminaires on high poles spaced at relatively large distances. Their purpose is not only to illuminate the nighttime street for safer vehicle operation, but also to improve pedestrian and neighborhood security.

Street lighting in traditional neighborhoods serves the same purposes as that in standard suburban neighborhoods. However, the intensity and location of the lights are on a more pedestrian scale. Smaller, less intense luminaires are often less obtrusive to adjacent properties and allow the nighttime sky to be seen. They only illuminate the streetscape as intended.

Sidewalk Width and Location

Sidewalks in suburban neighborhoods typically have a minimum width of 1.2 m (4 ft). While they may lie parallel to the street, they may also meander within the right-of-way or lie entirely outside of it.

TND designers try to keep walking as convenient as possible, and this results in shorter distances when sidewalks remain parallel to the street. The focus is on a safe and pleasant walking experience. The typical minimum sidewalk width is 1.5 m (5 ft) because this distance allows two pedestrians to comfortably walk side-by-side. Walking distances should be kept as short as possible, and in traditional

neighborhoods, horizontally meandering or vertically undulating designs are avoided even though these features may add interest. Neither should a pedestrian route be perceived as longer than the same driving route, nor should it create undue mobility problems for visually impaired pedestrians or people who use wheelchairs.

Building Setbacks

Standard suburban developments feature front setbacks of 4.6 m (15 ft) or more for several reasons. Setbacks allow road widening without having to take a building and compensate its owner. They help sunlight reach buildings and air to circulate. In addition, side and rear setbacks afford access by public safety officials.

Traditional designs have no minimum setback and, indeed, maximums may be specified by some policymakers. The goal is to integrate residential activity and street activity and, for example, to allow the opportunity for passers-by to greet neighbors on their front porches. Furthermore, the walls of nearby buildings help to vertically frame the street, an important aesthetic dimension.

TND projects are intensely planned and closely regulated as to types and ranges of use and location. Such planning affords the otherwise unusual opportunity to have a good degree of understanding about the future traffic demands for a street and to design for those needs. Furthermore, to minimize the need for future widening, TND streets have adequate rights-of-way, typically not too dissimilar to standard requirements, and the buildings do not encroach on the right-of-way. Within the right-of-way, the typical TND street will have a planting strip of 1.8 m (6 ft) or so on each side, and parking lanes on both sides of the street (sometimes striped, sometimes not), both of which provide opportunities for some widening without a great deal of effort if in the future a wider street is needed.

Parking

The importance of parking for suburban projects cannot be overemphasized because nearly all trips are by car. Off-street parking is preferred; indeed, large parking lots immediately adjacent to the street give a certain status to retail and commercial establishments (see figure 6-5). Sometimes, suburban parking is allowed on the street in front of smaller stores. Because of the importance of vehicle access in suburban development, city ordinances typically establish minimum parking criteria.



Figure 6-5. Photo. Typically, suburban parking lots in retail developments are vast—and rarely full.

Traditional design encourages on-street parking by counting the spaces toward maximum parking space requirements. The parking is usually no more than one layer deep. If the adjacent development contains residential and other uses, parallel parking is recommended. In commercial areas, 90-degree head-in and diagonal parking are permitted. Parking lots are usually built behind stores. As a result, the street front is not interrupted by a broad parking area.

On-street parking is a concern for some traffic engineers. The concern is that dart-out crashes (where pedestrians, especially children, dart out from between parked vehicles into the traffic stream) will increase if on-street parking is encouraged. The proponents of TND projects argue that a row of parked vehicles enhances pedestrian activity by creating a buffer between pedestrians and moving traffic, that the overall street design slows moving traffic so that any crashes that do occur are less severe, and that the active streetscape makes drivers more alert to pedestrians. There is also some evidence that children in standard neighborhoods are susceptible to driveway backing crashes. On-street parking, therefore, must be limited to streets where the design fosters low speeds (32 km/h (20 mi/h) or less) for moving traffic.

6.5 Student Exercise

If a completed traditional neighborhood or transit-oriented development is located nearby, conduct a thorough critique of it. Does the development adhere to the guidelines in this chapter or to others published on this topic (see reference list below)? Does the development include a mix of land uses? What types of destinations can residents walk to? Describe the successful elements of the neighborhood, as well as the unsuccessful elements.

6.6 References and Additional Resources

The references for this lesson are:

1. Post, Nadine M., “Putting Brakes on Suburban Sprawl,” *Engineering News-Record*, May 9, 1994, pp. 32–39.
2. *A Policy on Geometric Design of Highway and Streets*, 5th ed., AASHTO, Washington, DC, 2004.

Additional resources for this lesson include:

- Bressi, T., Ed., *The Seaside Debates: A Critique of New Urbanism*, Rizzoli Publications, New York, NY, June 2002.
- *Congress for the New Urbanism*, available online at <http://www.cnu.org>, accessed March 21, 2004.
- Gordon, P., and H.W. Richardson, “A Critique of New Urbanism,” presented at the meeting of the American Collegiate Schools of Planning, Pasadena, CA, November 1998.
- “*Neighborhood Street Design Guidelines: An ITE Proposed Recommended Practice*,” ITE Journal, *ITE*, 2004.
- *Portland Pedestrian Design Guidelines*, Office of Transportation Engineering and Development, Portland, OR, 1998.
- *Traditional Neighborhood Development Street Design Guidelines: Recommended Practice*, ITE, Washington, DC, 1999.

LESSON 7:

ADAPTING SUBURBAN COMMUNITIES FOR BICYCLE AND PEDESTRIAN TRAVEL

7.1 Introduction

Typically, suburban areas in the United States are exclusively oriented to automobile travel. Most suburbs do not accommodate bicyclists and pedestrians, and they rarely provide good access to transit (with a few exceptions). With all this in mind, however, it is necessary to expand walking and bicycling travel opportunities in the suburbs without eliminating the car. Suburbs were organized around automobile travel and, in many instances, will not function well without it.

This session explores methods of redesigning suburban communities to better accommodate nonmotorized transportation. It discusses how the suburbs developed, the hierarchy of the street system, and appropriate modifications that can accommodate and encourage bicycling and walking. It includes a discussion of Safe Routes to Schools programs, and how they can be utilized to focus attention on pedestrian conditions within suburban neighborhoods. This session is mostly oriented toward suburban planning considerations—with references to other sections that focus on design issues such as traffic calming and walkway/bikeway design.

The major sections of this lesson are as follows:

- 7.1 Introduction
- 7.2 History of Suburban Development
- 7.3 Costs of Sprawl
- 7.4 Present Suburban Land Uses
- 7.5 Planning with the Car in Mind
- 7.6 Strategies for Retrofitting Suburban Arterial Roadways
- 7.7 Safe Routes to School Planning
- 7.8 Existing Retail/Office Developments
- 7.9 Student Exercise
- 7.10 References and Additional Resources

7.2 History of Suburban Development

Before the automobile became a part of most American households, city dwellers relied on walking for their transportation close to home and on streetcars, trolleys, or trains for longer trips. The streetcar and railroad lines generally ran from cities to outlying neighborhoods where houses and businesses clustered near major stops. People usually walked from their homes to public transportation, much as they walked from home to the business district to do their shopping.

As more and more people were able to afford their own cars, dependence on streetcars, trolleys, and trains diminished as did the need to live near them. Since land farther away from the city was less expensive, people from city neighborhoods began to see the fulfillment of a dream to own a detached home with land around it. When developers of these homes learned that people would be willing to drive a little farther to

buy even less expensive land, leapfrogging began. Leapfrogging is the practice of developing less expensive land farther from the city while leaving vacant more expensive land closer to the city. Developers of schools, businesses, and parks also sought the least expensive land. Thus, the result was scattered facilities and communities with no central focus. Because suburban building became so scattered, streetcar and rail transit were less cost-effective, ending usually at the city's edge, and the car became the main means of transportation for suburban residents.

That suburban activities require the use of a car and generate a large amount of traffic is well known. In suburban commercial areas, heavy traffic starts early in the morning and lasts for the entire day until beyond the end of evening rush hour. Traffic is heavy because of the many trips from store to store made by shoppers who find driving between stores easier than walking or bicycling, even though distances may be short enough for these activities. Because of the active, internally generated traffic, walking, and bicycling are not safe, pleasurable, or convenient. Consequently, before viable pedestrian improvements can be made, all-day peak traffic must be corrected.

The land use changes needed to remedy these conditions include increasing density and mixing land use, two actions residents of suburbs often believe are inappropriate for suburban lifestyles. Many communities have already begun to alter land regulations to prevent suburban sprawl. Apartments and commercial developments are now being built along arterials and on land bypassed by leapfrogging. The pattern of development in many suburbs is infilling. This present pattern of infill development is providing more opportunities for design to accommodate pedestrians and bicyclists and to promote bus transportation.

In some regions where approaches to land use are not consistent between neighboring cities or counties, development may be concentrated in those jurisdictions with the least strict land use control. This development leads to megaleapfrogging, a good reason to promote land use controls on a regional basis.

Here, three typical pedestrian problems—safety, function, and comfort—should be addressed. Safety problems are real or perceived conflicts as people cross streets or walk where there are no sidewalks. Since suburban drivers cover longer distances and drive faster, the dangers to pedestrians become magnified. The absence of pedestrians on suburban streets dulls drivers' awareness and further aggravates the problem of safety. Functional pedestrian problems are found wherever there is little or no walking space, a lack of sidewalks, parked cars along the road's edge, wide driveways, few benches, and barriers (see figures 7-1 and 7-2). Beyond this, another functional problem is the lack of destinations within reasonable walking distance. Finally, problems that create uncomfortable environments for pedestrians and bicyclists are: walking next to noisy, fast moving cars; poor vistas; few rest stops; streetscapes with little interest to someone who is not driving; and vacant lots or large parking lots that are visually dull and potentially unsafe.



Figure 7-1. Photo. Inadequate maintenance of sidewalks makes a short walk difficult to maneuver.



Figure 7-2. Photo. Parked cars and a lack of sidewalks along the road's edge create unsafe conditions for bicyclists and pedestrians.

Abandoning the Street

The long driving distances necessary to serve low-density areas increase the speed and volume of suburban traffic, making streets dangerous and uncomfortable places (see figure 7-3). To counter this discomfort, an inside-out development pattern—the opposite of the prevalent urban development patterns—has evolved. While most urban communities focus on and utilize the street, suburban communities turn their backs to the street, and focus human activities on internal gardens, courtyards, and other private or internal, if open, spaces. Typically, car parking distances front doors from the sidewalk, and makes using the car seem most natural. Unfortunately, the internal spaces are seldom interconnected, so walking or bicycling for long distances through or between them is not often possible.



Figure 7-3. Photo. Sidewalks with a landscape strip should be installed to minimize exposure to vehicular traffic.

A shift has occurred from the urban grid pattern to a suburban road hierarchy. The grid typical of many cities allows free choice of routes but does not necessarily distinguish between high or low volumes of traffic or between streets that may or may not be good locations for raising families. With its system of roads, from arterials carrying high traffic volumes to cul-de-sacs with virtually no vehicular traffic, the suburban hierarchy changed all that. The secret of the hierarchy lay in not interconnecting streets, which positively directed through traffic to arterials. This made cul-de-sacs the preferred residential streets.

Grid patterns developed when travel by foot was important. As the grid was infinitely divisible, it created a fine-grained network that benefited foot traffic. The hierarchy developed to accommodate the automobile by recognizing that cars can easily travel extra distances—as traffic disperses, certain roads should carry more or less traffic than others. Pedestrians, unfortunately, cannot easily travel longer distances, and are the losers.

In its conceptual form, the hierarchy includes a separate and internal pedestrian system that purportedly ensures pedestrian access to different parts of the community. Unfortunately, these internal systems were not provided in most cases, and where they were, they did not lead to places people wanted to reach because those were located on the roads. Internal circulation spaces were often unsafe because they

lacked foot traffic and the varied ownership made access dependent on private property rights. Remedying these conditions requires a strategy of: linking internal spaces where possible and making the street usable for pedestrians and bicyclists will enhance suburban living for many people.

7.3 Costs of Sprawl

Several groups have argued that the costs of suburban sprawl are much higher than alternative development forms, particularly when considering all of its externalities. In recent years, planners and researchers have begun to quantify the costs of sprawl to the environment and health of communities. In the first comprehensive study on the health effects of sprawl, a team of researchers found a close relationship between the type of community they live in, and their level of activity, weight, and health. One study, titled *Relationship Between Urban Sprawl and Physical Activity, Obesity, and Morbidity*, found that “people living in counties marked by sprawling development are likely to walk less and weigh more than people who live in less sprawling counties. In addition, people in more sprawling counties are more likely to suffer from hypertension (high blood pressure). These results hold true after controlling for factors such as age, education, gender, and race and ethnicity.”⁽¹⁾

For more information on the costs of sprawl, please see the references at the end of this lesson.

7.4 Present Suburban Land Uses

Suburban land uses affecting pedestrians can be divided into three categories. First, there are individual tract subdivisions, planned as units, with a sense of order derived from the in-road systems. Access is limited to one or two points. Most are single-family residential, though some warehousing, shopping, and medical developments exhibit the same characteristics. The distinguishing characteristics are that each subdivision is a recognizable unit, planned as a whole, that can be replanned to better serve the pedestrian.

The second type of land use is the linear arterial. While the roadway portion of arterials most likely was engineered, land use planning may never have occurred or may have been haphazard. However, arterials with these activities form the backbone of most suburban communities, serving both long-distance driving and local business transactions. Arterial strips often convey a sense of the community’s image or identity. While at present this image is seldom distinguishing or pleasant, it could be improved with pedestrian/bicycle-related amenities.

Arterials are obvious locations for bicycle and pedestrian improvements since these roads pass most community facilities and are the only direct and relatively long through roads in the suburban community. However, most arterials have pedestrian safety and environmental problems that must be overcome. If these problems are too great, it may be possible to improve a route parallel to the arterial but one block removed.

The third general type of suburban land use is bypassed land, forgotten during initial development as entrepreneurs leapfrogged out to find cheaper land. These lands infill more slowly and more haphazardly than planned subdivisions and are likely to have many owners and a variety of land uses, although perhaps not as many as along arterials. Bypassed lands may be the easiest to adapt to pedestrian- and bicycle-related improvements, as they typically have the highest densities, have mixed land uses, and are close to a variety of services.

The most dangerous places for pedestrians are along suburban roads without sidewalks and intersection treatment. These roads are usually arterials located near schools, commercial areas, or businesses. Intersections of residential streets and other arterials that have no sidewalks or signals also contribute to

risk. Moreover, bus stops are often located where there are no sidewalks, contributing further to pedestrian hazards.

7.5 Planning With the Car in Mind

While suburbs were designed around the automobile (see figure 7-4), the car need not always be dominant and uncontrolled. Increased car use has constrained its own flexibility because roads have become more crowded and fuel costs have risen. Extending pedestrian and bicycle access within a community may eliminate some need for the car, allowing increased flexibility for those who have to drive. Walkways should be planned for physical and psychological safety from the auto, yet allow direct and easy access to all types of activities. Most walkways should be planned in conjunction with roads, so pedestrians can reach all developments that are located along the road.



Figure 7-4. Unless required by local ordinance, many developments focus on vehicle access without regard to pedestrian access.

7.6 Strategies for Retrofitting Suburban Arterial Roadways

Suburban areas typically consist of many small residential developments, each abutting a major road. These major roads lead to services such as shopping, schools, and parks. Pedestrian and bicycle safety problems may be less of an issue inside individual suburban developments (unless they are large), but they increase on collectors and arterials both within and adjacent to neighborhoods.

A variety of techniques are available to retrofit busy roadways to better accommodate bicycling and walking. Urban planners and design engineers have begun to apply very creative methods so that heavy volumes of traffic can coexist with pedestrian and bicycle activity. Examples are given in lessons 3 and 4 of this course. The following is an overview of techniques provided:

1. **Independent retrofit projects.** Many suburban and urban arterials in the United States could benefit greatly from certain basic safety provisions for bicyclists and pedestrians. Examples include eliminating gaps in the sidewalk (providing sidewalks on both sides of the road), improving accessibility at intersections and driveways, using better signal technologies (such as pedestrian countdown signals, leading pedestrian intervals, and others), providing shorter crossing distances at intersections and median refuges wherever possible, improving midblock crossings, adding bike lanes and shared-use paths, and other types of improvements.
2. **Reevaluating the need to widen the road.** As a long-term cost-saving measure, roadways are often widened to meet the anticipated traffic volumes two decades hence. These traffic projections are based on many assumptions that may not be realized and often result in very wide roadways built to handle far more traffic than they carry today. Communities must carefully consider the impact of extremely wide roads on other modes of transportation during the intervening years. The costs in reduced mobility may not be worth it.
3. **Road diets.** Some roads have more travel lanes than necessary and are difficult to cross because of their width. Reducing the number of lanes on a multilane roadway can reduce crossing distances for pedestrians and may slow vehicle speeds. A traffic analysis should be done to determine whether the number of lanes on a roadway (many of which were built without such an analysis) is appropriate. Level-of-service analysis for intersections should not dictate the design for the entire length of roadway. For example, a four-lane undivided road can be converted to one through lane in each direction, with a center left-turn lane or raised median, and turn bays and bicycle lanes on both sides of the roadway. Turn bays may be needed only at specific locations.

Depending on conditions, it may also be possible to add on-street parking while allowing for bicycle lanes on both sides of the street instead of a center turn lane. If no sidewalks exist along the roadway, these should be added. If sidewalks exist, and there is adequate room, a landscaped buffer is desirable to separate pedestrians from the travel lane.

4. **Form-based codes.** As described in lesson 5, retrofitting busy roads to accommodate pedestrians and bicyclists does not stop with the roadway and sidewalks. The planner must also be concerned with the development that lies alongside the roadway. By establishing new codes that require new and redeveloped properties to be pedestrian-oriented, the street can begin to function for more than just automobile traffic. Form-based codes are one tool to accomplish this. For more information, see lesson 5.

7.7 Safe Routes to School Planning

A Safe Routes to School program is a way to improve the safety of children who walk or bicycle to school and to promote these types of transportation. During a Safe Routes to School program, parents and school administrators work with other community groups and agencies to build new sidewalks, improve pedestrian crossings, teach children safer bicycling and walking skills, and promote healthier, more active lifestyles.

The America Bikes campaign described the Safe Routes to School movement in the following way:

Safe Routes to School began as a grassroots movement to make it safe, convenient, and fun for children to bicycle and walk to school. ...

A recent national survey found that while 70 percent of parents walked or bicycled to school as children, only 18 percent of their children walk or bike to school today. The

parents listed distance, heavy traffic, fear of crime, inconvenience, as among the reasons their children do not walk. Many communities are no longer set up for the walk to school: subdivisions lack sidewalks, or are separated from school by a busy multilane arterial road.

A lifestyle geared to the automobile means parents and children spend more time than ever in the car—more than an hour a day now for the average child in the United States. Millions of parents now drop the kids at school on the way to work, creating traffic jams in school parking lots. Meanwhile, many children are struggling with being overweight, and 15 percent of children are now considered obese, putting them at risk of a number of chronic diseases.

Parents, public health officials, school administrators, and others who recognize the benefits of children walking to school have begun programs to make it safe and fun for children to get to school under their own power. They see walking to school as an easy way for kids to get essential physical activity, slowing the obesity epidemic among children. And they believe this simple activity can help ease the traffic jams and air pollution that are degrading quality of life for children and adults alike.⁽²⁾

There are three distinct phases in each Safe Routes to School program. In the first phase, participants generate interest and enthusiasm about the project, and identify and assemble a core group of people who will help with the project. Often, this effort includes participation in Walk to School Day (held each October), or other promotional efforts. For the second phase, a group works together and conducts outreach to identify the types of improvements and safety programs that are needed. The third phase is implementation—that is, getting projects built, putting education and encouragement programs in place, and any other activities identified to make the journey to school safer.

7.8 Existing Retail/Office Developments

Entrances to many commercial and retail centers are oriented toward automobile travel. Bicycle and pedestrian access to storefronts is not only difficult and awkward, but often unsafe. For the purpose of this discussion, a shopping center serves as an example of how to retrofit existing developments to accommodate pedestrians. The same principles apply to other types of developments such as office complexes and multifamily housing.

A typical shopping center or strip mall is separated from the roadway by a wide parking lot that averages between 90 and 150 m (300 and 500 ft) in depth. Often, no pathways link store entrances to the sidewalks along the street, and sometimes there are no sidewalks on the street to be linked. Parking lots with multiple entryways allow traffic to circulate in different directions, creating hazards and confusion for walkers and cyclists. Drive-throughs at banks and fast-food restaurants in out-parcel developments add to pedestrian safety problems and encourage people to drive between different destinations on the site.

Storefronts do little to encourage walking. They are often barren and devoid of windows and are therefore visually unappealing to a pedestrian (see figure 7-5). If they exist, walkways between stores are often narrow and uncovered, and pedestrian amenities such as benches are rare. Pedestrian connections between developments are not provided, encouraging shoppers to get back in their automobiles to access adjacent developments.



Figure 7-5. Photo. Building entrances and storefronts should be oriented to face the street.

Although the problems with shopping centers are numerous, they can be redeveloped to better serve pedestrians. As older shopping centers undergo renovations, they should be redesigned to serve customers who arrive via transit, automobile, bicycle, and on foot. Specific methods include:

- Maximize pedestrian and transit access to the site from adjacent land uses:
 - Provide comfortable transit stops and shelters with pedestrian connections to the main buildings; transit stops and pedestrian drop-offs should be located reasonably near to building entrances—preferably no more than 225 m (750 ft), and ideally much closer than that.
 - Provide attractive pedestrian walkways between the stores and the adjacent sites.
 - Ensure that fencing and landscaping does not create barriers to pedestrian mobility.
- Improve the layout of buildings and parking lots:
 - Increase the density of existing sites by adding new retail buildings in the existing parking lots, with offices or multifamily housing around the perimeter of the site.
 - Locate parking lots on the sides and to the rear of buildings, with major retail situated closer to the street.
 - Rework entrances and orient buildings toward pedestrian and transit facilities instead of parking lots.
 - Arrange buildings onsite to reduce walking distance between each building and between the nearest transit facility.
 - Provide covered walkways around and between buildings if possible.

- Improve onsite pedestrian circulation and safety measures:
 - Connect all buildings onsite to each other via attractive pedestrian walkways, with landscaping and pedestrian-scale lighting. Provide covered walkways where possible.
 - Minimize pedestrian/auto conflicts by consolidating auto entrances into parking lots.
 - Separate roads and parking lots from pedestrian pathways through the use of grade changes.
 - Implement safety measures at pedestrian crossings, warning signage, tight corner radii, and other measures (see figure 7-6 and see lesson 20 on traffic calming).



Figure 7-6. Photo. Medians and crosswalks should be placed at destination locations such as this shopping center.

7.9 Student Exercise

Describe 10 to 15 ways in which you would propose to retrofit a nearby residential development (or one that you grew up in) to make bicycling and walking viable forms of transportation. Elaborate on each idea, explaining how it would work and why it would improve the livability of the community.

7.10 References and Additional Resources

The references for this lesson are:

1. Ewing, R., Schmid, T., Killingsworth, R., Zlot, A., and Raudenbush, S., “Relationship Between Urban Sprawl and Physical Activity, Obesity and Morbidity,” *American Journal of Health Promotion*, September 2003.
2. America Bikes Campaign (publication pending), <http://www.americabikes.org/saferoutestoschool.asp>.

Additional resources for this lesson include:

- *Design and Safety of Pedestrian Facilities—A Recommended Practice of the ITE*, ITE, Washington, DC, 1998, available online at http://safety.fhwa.dot.gov/ped_bike/docs/designsafety.pdf.
- *Maryland Safe Routes to Schools Guidebook*, Maryland Department of Transportation, 2004, Hanover, MD, available online at http://fha.state.md.us/fha/cphs/chn/pdf/SR2S_Guidebook_1.pdf.
- *Oregon Transportation Rule: Recommendations for Pedestrian, Bicycle and Transit-Friendly Ordinances*, Oregon Chapter of the American Planning Association, West Linn, OR, 1993,.
- PBIC, Engineering Treatments page, available online at <http://www.walkinginfo.org>, accessed May 2004.
- Untermann, Richard K., *Accommodating the Pedestrian*, Van Nostrand Reinhold Company, Inc., New York, NY, 1984.

LESSON 8:

PEDESTRIAN CHARACTERISTICS

8.1 Introduction

A roadway that is designed to accommodate pedestrian use must take into account the wide range of needs and physical capabilities of different pedestrian groups. An agile, able-bodied person can frequently overcome design deficiencies. However, when age or functional disabilities reduce a person's mobility, sight, or hearing, a good design becomes very important.

This section provides an overview of basic pedestrian characteristics that most often come into effect when designing pedestrian facilities in the public right-of-way. It discusses the walking speeds and space requirements of these various groups and the roadway design elements required to accommodate them. The major sections of this lesson are as follows:

- 8.1 Introduction
- 8.2 Characteristics of Different Age Groups
- 8.3 Other Pedestrian Types and Characteristics
- 8.4 Walking Speeds
- 8.5 Space Requirements
- 8.6 Design Requirements
- 8.7 Student Exercise
- 8.8 References and Additional Resources

Pedestrian design currently features at least two schools of thought: traditional engineering design and the design of accessible rights-of-way. Traditional engineering employs designs based on minimum cost and maximum efficiency. This premise is decades old and consists of designing roadways for the most likely common user, a specific design vehicle, design hourly volume, etc. For example, a curb radius on a residential street is not large enough to accommodate all vehicles. Large trucks will swing wide into the opposing lane and use both directions on the receiving roadway. Likewise, roadways are built to accommodate a certain design hour traffic that is less than the greatest traffic volume, which often results in congestion during part of the day. The cost to accommodate all vehicles on all facilities is deemed to be cost-prohibitive.

Designing accessible rights-of-way is based on the concept that no one should be discriminated or denied access to public facilities or services. The United States Access Board has developed minimum accessibility standards for certain road design features such as curb ramps and detectable warnings. These design elements are to be provided as a matter of law. However, there are other right-of-way design features for which no enforceable accessibility standards currently exist, such as pedestrian signal timing or roundabouts. Where no enforceable accessibility design standards exist, engineers must make decisions about roadway design that directly affect the users. Advocates for the disabled recommend that roads be designed for all users with disabilities—increasing the accessibility for users with disabilities increases the accessibility for all users. Until enforceable accessibility standards are developed, however, some public agencies will continue traditional design practices that best serve the majority of users to the exclusion of others.

Even with limited resources (right-of-way, environmental, time, etc.), new designs and methods will emerge that attempt to accommodate all users in a safe and efficient manner. This lesson will present both methods so that the reader can decide what is most appropriate at the time. Some of these methods will be addressed by law and some will be addressed by policy.

Regardless of what finally emerges from this debate, currently, new and altered facilities must be designed and constructed to be accessible to and usable by individuals with disabilities; existing facilities and programs must achieve program accessibility. Examples of alterations in rights-of-way construction include roadway realignment or widening, or the addition of a sidewalk along an existing right-of-way. Where additional right-of-way is acquired for a roadway project, it is important to consider accessible sidewalk construction; improved access to adjacent sites and existing facilities should also be considered.

8.2 Characteristics of Different Age Groups

Table 8-1 lists some common characteristics of pedestrians in different age groups. The table was adapted from the *Florida Pedestrian Planning and Design Handbook* and chapter 2 of the *County of Sacramento Pedestrian Design Guidelines*.^(1,2)

Young Pedestrians

Child pedestrians have important characteristics that separate them from the adult pedestrian population and make them a particular concern for roadway designers. Until the age of about 10 years, children have a limited concept of rules and why they are needed. They often have problems with risk perception, attention, and impulsivity that make them more vulnerable pedestrians. In addition to adult supervision and effective education programs, careful design of the places children walk most, such as school zones and school walking routes, neighborhood streets, and parks, can significantly help to improve their safety.

Children's comprehension of safety is poorly formulated, and their understanding of critical behaviors, such as crossing the street, are not well developed. This is one among many reasons for the relatively high crash rate among young pedestrians. The following factors also appear to contribute to the child pedestrian problem:⁽³⁾

- Their small stature makes it difficult for them to see and evaluate the entire traffic situation correctly.
- They have limited information processing in peripheral vision and poorer visual acuity until about the age of 10 years.
- They have difficulty distributing their attention and are therefore easily preoccupied or distracted.
- They have difficulty discriminating between right and left.
- They have difficulty in correctly perceiving the direction of sound and the speed of vehicles.
- They have a poor understanding of the use of traffic control devices and crosswalks.
- They have difficulty in judging distances of cars and when a safe gap occurs between vehicles.
- They tend to believe that adults will always be kind to them, so drivers will be able to stop instantly if they are in danger.

Table 8-1. Walking characteristics and abilities of different pedestrian age groups.

Source: *Florida Pedestrian Planning and Design Handbook* and the
County of Sacramento Pedestrian Design Guidelines^(1,2)

<p>Infants and Toddlers (ages 0 to 4)</p> <p>At this age, walking skills are just being developed and the children require constant parental supervision. Infants and toddlers are very limited in ability and are:</p> <ul style="list-style-type: none">• Learning to walk.• Developing peripheral vision and depth perception.• Impulsive and unpredictable.
<p>Young Children (ages 5 to 12)</p> <p>At a young age, children have unique abilities and needs. Since children this age vary greatly in ability, it is important for parents to supervise and make decisions on when their child is ready for a new independent activity. Children in this age range tend to be:</p> <ul style="list-style-type: none">• Impulsive and unpredictable.• Limited in their peripheral vision (a sound source is not easily located).• Limited in training/lacking in experience.• Thrilled or excited by close calls.• Short and hard to see by drivers.• Susceptible to darting or dashing out into the intersection.• Likely to copy the behavior of older people.
<p>Preteens (ages 13 to 14)</p> <p>By middle school years, children have many of their physical abilities but still lack experience and training. Now there is greater desire to take risk. Preteens generally:</p> <ul style="list-style-type: none">• Lack experience.• Walk and bicycle more and at different times (have a higher crash exposure).• Ride more frequently under risky conditions (in high traffic).• Lack positive role models.• Walk across more risky roadways (collectors and above).• Get involved in more intersection dash collisions.• Have a sense of invulnerability that makes them more willing to take chances.
<p>High School Aged (ages 15 to 18)</p> <p>By high school and college age, exposure changes and new risks are assumed. Many walk and bicycle under low light conditions. Other characteristics of this age group are that they:</p> <ul style="list-style-type: none">• Are very active, can go long distances, and visit new places.• Feel invincible.• Still lack experience and training.• Are capable of traveling at higher speeds.• Will overestimate their abilities on hills, curves, etc.• Attempt to use bicycles, in-line skates, etc., based on practices carried over from youth.• Are willing to experiment with alcohol and drugs.

Table 8-1. Walking characteristics and abilities of different pedestrian age groups—Continued

<p>Adults (19 to 40)</p> <p>These adults are highly competent in traffic and capable of perceiving and dealing with risk in most circumstances. Some use bicycles for commuting and utilitarian trips, while others use bicycles primarily for recreation. This group generally:</p> <ul style="list-style-type: none">• Is active and fully aware of the traffic environment.• Comprises only 1–4 percent of bicycling population in most communities.• Tends to be very vocal and interested in improving conditions.• Has members interested in serving as instructors or task force leaders.
<p>Middle-Aged Adults (41 to 65)</p> <p>During this stage of life, many pedestrians experience a slowing of the reflexes necessary to observe, assess, and respond to traffic conditions.</p>
<p>Senior Adults (65+)</p> <p>Senior adults, ages 65 and up, begin a gradual decline in physical and physiological performance, with a rapid decline after age 75. Many are incapable of surviving serious injuries. These changes affect their performance. Seniors:</p> <ul style="list-style-type: none">• Walk more in older years, especially for exercise/independence.• May have reduced income and therefore no car.• All experience some reduction in vision, agility, balance, speed, and strength.• May have further problems with hearing, extreme visual problems, and concentration.• Have the tendency to focus on only one object at a time.• Have difficulty hearing vehicles approaching from behind.• All have greatly reduced abilities under low light/night conditions.• May overestimate their abilities.• Have a higher fatality rate than other pedestrians involved in collisions with motor vehicles.

Older Pedestrians

The experiences of older pedestrians are different from that of the young person. In general, they do not behave as irrationally as do many children and young adults. However, older pedestrians often have physical conditions that limit their abilities to accurately assess the traffic situation. Older people also tend to walk more than others because they have more free time, it is good exercise, and it is an inexpensive mode of travel for short trips. The elderly are more law abiding than the general population, and they may in fact be too trusting of traffic signals and of drivers when it comes to crossing the streets. They are more likely than younger pedestrians to be involved in crashes due to problems in information processing, judgment, and physical constraints. Following is a list of other characteristics of older pedestrians:

- Vision is affected in older people by decreased acuity and visual field, loss of contrast sensitivity, and slower horizontal eye movement.
- They often have difficulty with balance and postural stability, resulting in slower walking speeds and increased chances for tripping.
- Selective attention mechanisms and multitasking skills become less effective with age, so older people may have difficulty locating task-relevant information in a complex environment.

- They have difficulty in selecting safe crossing situations in continuously changing complex traffic situations, likely due to deficits in perception and cognitive abilities, as well as ineffectual visual scanning, limitations in time-sharing, and an inability to ignore irrelevant stimuli.⁽³⁾
- They have difficulty in assessing the speed of approaching vehicles, thus misjudging when it is safe to cross the road.
- They have slower reaction times and decisionmaking skills.
- Those with arthritis may have restricted head and neck mobility as well as difficulty walking.
- There is reduced agility for those who use canes or crutches for assistance.

8.3 Other Pedestrian Types and Characteristics

Table 8-2 lists some other types of pedestrians that can be grouped by their walking characteristics.

Table 8-2. Characteristics of other pedestrian groups.
Source: Adapted from *Florida Pedestrian Planning and Design Handbook*⁽¹⁾

<p>Impaired</p> <p>For those of us fortunate to live to an older age, 85 percent will have a permanent disability that limits our range of mobility. Disabilities are common through all ages, and the permanently disabled constitute at least 15 percent of our population. Those with permanent physical disabilities, often kept away from society in the past, are now walking and bicycling on a regular basis. Many others have temporary conditions, including pregnancy, and broken or sprained limbs that may restrict their mobility. The disabled group includes:</p> <ul style="list-style-type: none"> • Those who are visually impaired, hearing impaired, mobility impaired, mentally/emotionally impaired, or other. • Many older adults who have reduced abilities. • People who were previously institutionalized and are not trained to walk the streets. • Those dependent on alcohol or drugs who may be hard to recognize.
<p>Inexperienced</p> <p>Adults who have not walked and bicycled regularly as children, and who have not received training are not prepared to take on the challenges of an unfriendly urban environment. This group presents a particular challenge because:</p> <ul style="list-style-type: none"> • Ninety-five percent of adults are novice bicyclists. • Many are unskilled in urban walking. • Drinking can influence their abilities. • Many assume they have higher skills and abilities than they actually have. • Most carry over sloppy habits from childhood. • Many new immigrants are unprepared for urban auto traffic.
<p>Ethnic/Cultural Diversity/Tourism</p> <p>America is rapidly becoming a nation with no clear majority population. All groups need access and mobility in order to fully participate in society. Transportation officials must pay close attention to communication, the creation of ethnic villages, and subcultural needs and practices. Most of these people depend heavily on walking and transit to get around. Some newly arriving groups lack urban experience, and many are used to different motorist behavior.</p>
<p>Transportation Disadvantaged</p> <p>In most States, 30 to 40 percent of the population does not own a car because they are not able to drive, they choose not to drive, or they cannot afford to purchase or operate a car. Even though this group typically does not have special needs, these men, women, and children are highly dependent on walking, transit, and bicycling for their basic freedom, access, and mobility.</p>

Mobility-Impaired Pedestrians

Mobility-impaired pedestrians include those with wheelchairs, crutches, canes, walkers, guide dogs, prosthetic limbs, orthotics, or other assistive devices. Some may not require these devices but still have a disability that limits their range or speed of motion. Table 8-3 contains a list of design features that help accommodate mobility-impaired pedestrians.⁽²⁾

Table 8-3. Design needs of mobility-impaired pedestrians.

Source: Adapted from *County of Sacramento Pedestrian Design Guidelines*⁽²⁾

Wheelchair Users <ul style="list-style-type: none">• Wider path and larger maneuvering space.• Surfaces with low cross slopes, low grades, smooth surfaces, and level terrains.• Firm, stable surfaces and structures such as ramps or beveled edges to negotiate changes in level.• Gradual rate of change of cross slope in such places as driveways and aprons.
Walking-Aid Users <ul style="list-style-type: none">• No grates and cracks which could catch or hinder the walking-aid.• Longer pedestrian signal cycles at intersections and the presence of passing spaces to allow others to travel around them.• No rapid change in cross slope that could cause people with walkers to stumble.
Prosthesis Users <ul style="list-style-type: none">• Extended signal timing at wide intersections.• Low grades and cross slopes.
People with Visual Impairments <ul style="list-style-type: none">• Detectable warnings (surfaces that can be detected underfoot and by a person using a cane through texture, color, and resilience).• Wayfinding information that provides orientation information to the user.• Visual cues, tactile surfaces, or audible pedestrian signals that can make information about traffic flow and street crossings more accessible.
People with Hearing Impairments <ul style="list-style-type: none">• Areas with long sight distances relatively free of visual obstructions such as landscaping.
People with Cognitive Impairments <ul style="list-style-type: none">• Signs that use pictures, universal symbols, and colors rather than words to convey meaning to a broad range of people.

8.4 Walking Speeds

Pedestrians have a wide range of needs and abilities. The *Manual on Uniform Traffic Control Devices for Streets and Highways* (MUTCD) recommends a speed of 1.2 meter/second (m/s) [4.0 feet/second (ft/s)] for calculating pedestrian clearance intervals for traffic signals.⁽⁴⁾ It also includes a comment that where pedestrians who walk slower than normal, or pedestrians who use wheelchairs, routinely use the crosswalk, a walking speed of less than 1.2 m/s (4.0 ft/s) should be considered in determining the pedestrian clearance times. Other studies have identified pedestrian walking speeds ranging from 0.6 to 1.3 m/s (2.0 to 4.3 ft/s). The ITE publication, *Design and Safety of Pedestrian Facilities*, even cited walking speeds up to 2.4 m/s (8 ft/s).⁽⁵⁾

By definition, about half of all pedestrians travel at a slower pace than the average walking speed. These slower walking pedestrians include older pedestrians, people with disabilities, and people pushing a baby

stroller and/or paying attention to younger children walking alongside (see figure 8-1). Therefore, the slower walking speeds of these groups should be considered when designing pedestrian facilities such as crossing times at intersections.



Figure 8-1. Photo. People with children often walk at slower speeds.

Older Pedestrians

Guidelines and Recommendations to Accommodate Older Drivers and Pedestrians recommends an assumed walking speed of 0.9 m/s (2.8 ft/s) for less capable older pedestrians because of their shorter stride, slower gait, difficulty negotiating curbs, difficulty judging speeds of oncoming vehicles, and exaggerated startup time before leaving the curb (see figure 8-2).⁽⁶⁾ Mean startup time (from the start of the Walk signal to the moment the pedestrian steps off the curb and starts to cross) was 2.5 seconds for older pedestrians, compared to 1.9 seconds for younger ones.⁽³⁾ A study in Sweden found that pedestrians aged 70 or older, when asked to cross an intersection very fast, fast, or at normal speed, considered fast to be less than 1.3 m/s (4.3 ft/s).⁽⁷⁾ The comfortable speed for 15 percent of the group was 0.7 m/s (2.2 ft/s), well below the standard often used.



Figure 8-2. Photo. Older pedestrians often have difficulty negotiating curbs.

Pedestrians with Disabilities

According to a study done in the United Kingdom in the 1980s, about 14 percent of adults over 15 years of age had physical, sensory, or mental disabilities.⁽⁸⁾ This population has become much more mobile in recent decades, and increasing efforts have been made to meet their transportation needs. As expected, the walking speeds for pedestrians with disabilities are lower than the average walking speed assumed for the design of pedestrian facilities.⁽³⁾ Table 8-4 shows some average walking speeds for various disabilities and assistive devices.

Table 8-4. Mean walking speeds for disabled pedestrians and users of various assistive devices.

Source: *Human Factors in Traffic Safety*⁽³⁾

Disability or Assistive Device	Mean Walking Speed, m/s (ft/s)
Cane or crutch	0.8 (2.62)
Walker	0.6 (2.07)
Wheelchair	1.1 (3.55)
Immobilized knee	1.1 (3.50)
Below-knee amputee	0.7 (2.46)
Above-knee amputee	0.6 (1.97)
Hip arthritis	0.7 to 1.1 (2.24 to 3.66)
Rheumatoid arthritis (knee)	0.7 (2.46)

8.5 Space Requirements

A recent study of pedestrian characteristics recommends for standing area design a simplified body ellipse of 50 centimeters (cm) by 59.9 cm [19.7 inches (in) by 23.6 in] for standing areas, with a total area of 0.3 square meters (m²) (3.2 square feet (ft²)), or roughly 108 percent of the ellipse suggested by Fruin's 1971 study (see figure 8-3).^(9,10) This study also recommends a body buffer zone of 0.8 m² (8.6 ft²) for walking.

Georgia's *Pedestrian Facilities Guidebook* states that two people walking side by side or passing each other while traveling in opposite directions take up an average space of 1.4 m (4.7 ft) with adequate buffer

areas on either side (see figure 8-4).⁽¹¹⁾ The minimum width that best serves two pedestrians walking together or passing each other is 1.8 m (6 ft). More space may be required, such as 2.7–3.9 m (8.7–12.7 ft), to accommodate situations where three or more people are walking abreast.

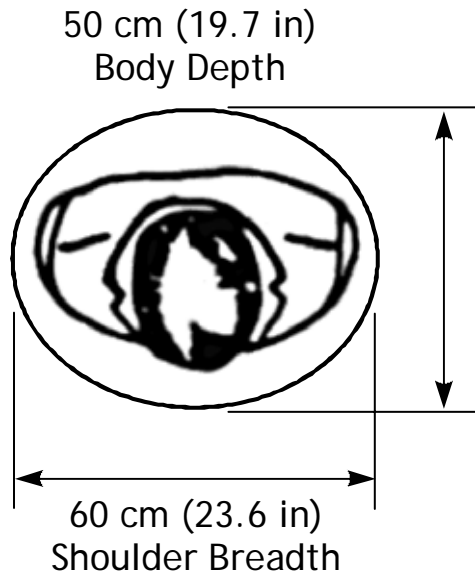

Figure 8-3. Illustration. Recommended pedestrian body ellipse dimensions for standing areas.

Source: Literature review for the *Highway Capacity Manual*⁽⁹⁾

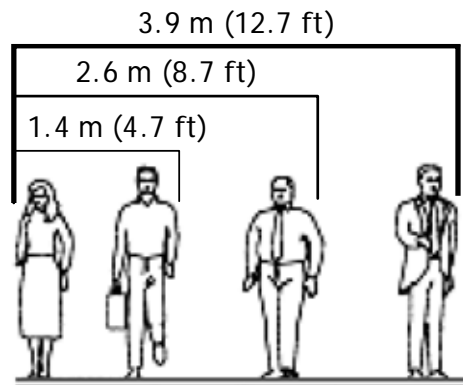

Figure 8-4. Illustration. Spatial dimensions for pedestrians.

Source: *Pedestrian Facilities Guidebook*⁽¹¹⁾

Spatial Bubbles

A spatial bubble is the preferred distance of unobstructed forward vision one experiences while walking under various circumstances.⁽¹¹⁾ Figure 8-5 illustrates the spatial bubbles that are comfortable for the average pedestrian while attending a public event, shopping, walking under normal conditions, and walking for pleasure.

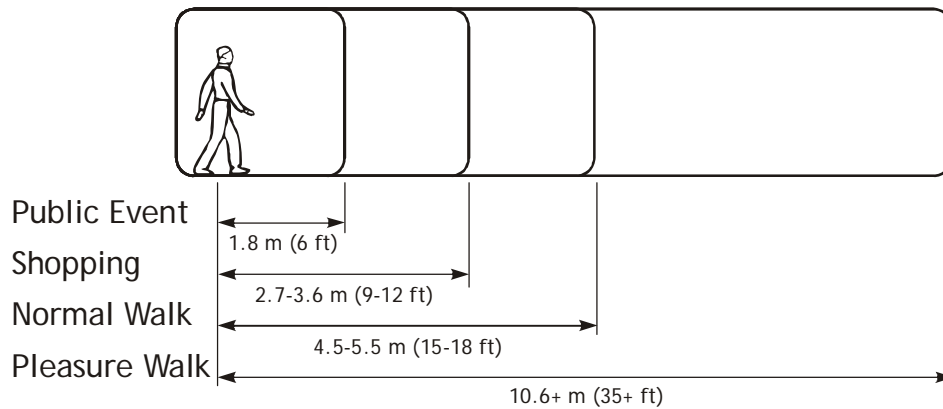
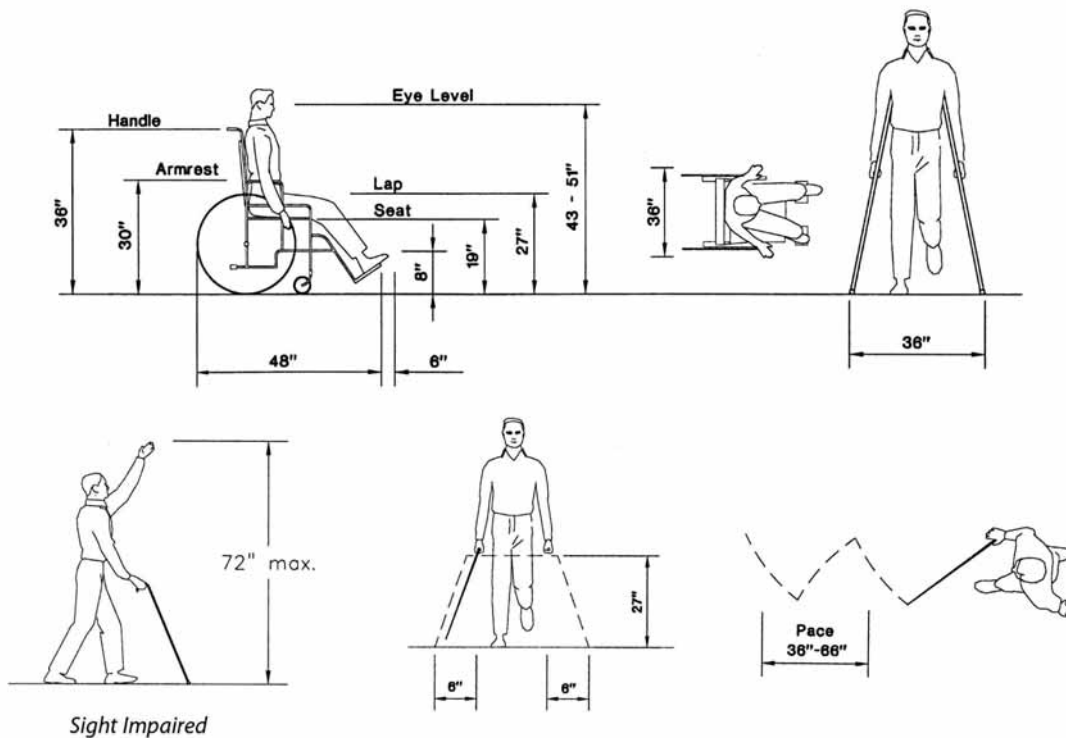

Figure 8-5. Illustration. Forward clear space needed by pedestrians.

Source: *Pedestrian Facilities Guidebook*⁽¹¹⁾

Pedestrians with Disabilities

Space requirements for pedestrians with disabilities vary considerably depending on the assistive device used. Spaces designed to accommodate wheelchair users are generally considered to be functional and advantageous for most people. Figure 8-6 illustrates the spatial dimensions needed for a wheelchair user, a person on crutches, and a sight-impaired person using the cane technique.



1 in = 2.54 cm

Figure 8-6. Illustration. Spatial dimensions for people who use mobility devices.

Source: *Pedestrian Facilities Guidebook*⁽¹¹⁾

8.6 Design Requirements

Roadways, sidewalks, and intersections that are designed to meet the needs of disabled pedestrians generally benefit all pedestrian movement. Below are some criteria for designing pedestrian facilities to accommodate all types of users.

Sidewalks

Two people walking side-by-side or passing one another generally require almost 1.5 m (5 ft) of space, while wheelchair and scooter users need more space in order to pass one another.⁽²⁾ However, the ADA states that 1.2 m (4 ft) is the “minimum width needed for an ambulatory person to pass a nonambulatory person.”⁽¹²⁾ A clear width of *at least* 1.5 m (5 ft) is preferred, especially if the area has a high volume of pedestrians with disabilities (see figures 8-7 and 8-8). If the width of the sidewalk is less than 1.5 m (5 ft), two wheelchair users will not be able to pass each other and will have to find a wider place for passing. Passing spaces must be located at reasonable intervals not to exceed 61 m (200 ft). ADA requirements “specify a minimum space of 1.5 m (5 ft) in diameter or a 1.5 m (5 ft) by 1.5 m (5 ft) T-shaped space for a pivoting 180-degree turn of a wheelchair.”⁽¹²⁾ A T-intersection of two corridors or walks is an acceptable passing place.

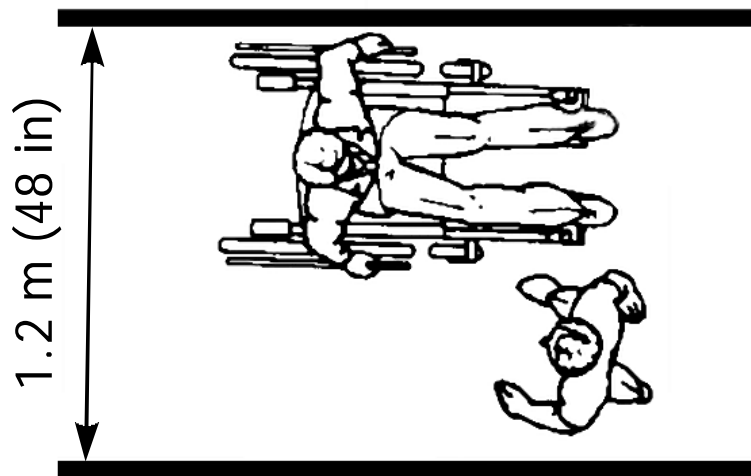

Figure 8-7. Illustration. Minimum passage width for one wheelchair and one ambulatory person.

Source: ADAAG,
<http://www.access-board.gov/adaag/html/adaag.htm>⁽¹²⁾

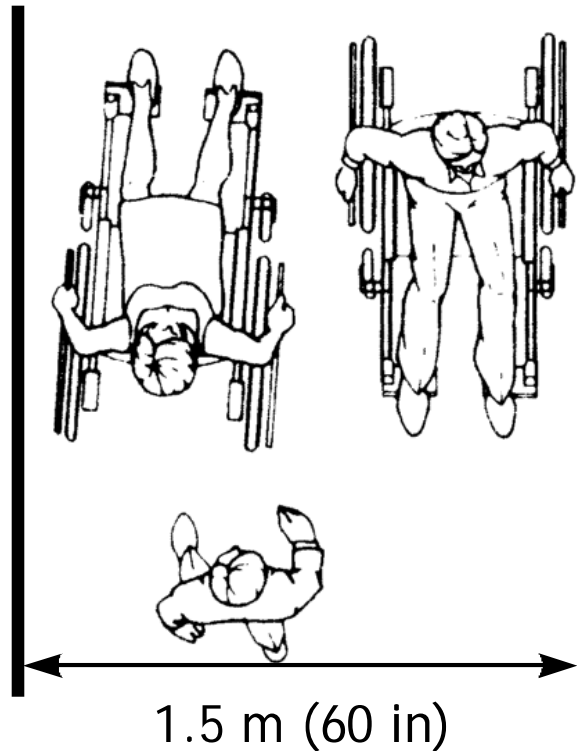

Figure 8-8. Illustration. Minimum passage width for two wheelchairs.

Source: ADAAG, <http://www.access-board.gov/adaag/html/adaag.htm>⁽¹²⁾

Sidewalks should be built and maintained in urban areas along all major arterial streets, in commercial areas where the public is invited, and at all transit stops and public areas. They should be paved with a smooth, durable material. It is desirable to have paved sidewalks on both sides of all streets in urban and suburban areas to provide mobility for disabled (as well as nondisabled) pedestrians. A planting strip, which serves as a buffer between on-street vehicles and pedestrians on the sidewalk, can be especially beneficial to visually impaired pedestrians on the sidewalk and to wheelchair users. Sidewalks should be kept in good condition, free from debris, cracks, and rough surfaces.

There should be enough sidewalk cross slope to allow for adequate drainage. The maximum cross slope should be no more than 2 percent (1:50) to comply with ADA requirements. A person using crutches or a wheelchair has to exert significantly more effort to maintain a straight course on a sloped surface than on a level surface. Driveway slopes should not encroach into the sidewalk. A 1.8 m (6 ft) setback will generally prevent this encroachment (see figure 8-9).

Several driveway design options are available to maintain the desired cross slope. Placing the sidewalk behind the driveway ramp or using curb ramps and aprons are two methods typically used. A minimum sidewalk width of four feet needs to be maintained regardless of right-of-way constraints. Ramp slopes also need to be adhered to when accommodating driveway crossings.



Figure 8-9. Photo. Driveway slopes should not encroach into the sidewalk.

Where the sidewalk is located adjacent to the street, it should be rerouted sufficiently away from the street (to the back of the right-of-way or on an easement, if necessary), out of the driveway slope.

Grades

Longitudinal grades on sidewalks should be limited to 5 percent. If a sidewalk is adjacent to a roadway with a grade exceeding 5 percent, the sidewalk grade must be less than or equal to the grade of the roadway. A pedestrian facility that is not along a roadway should have less than 5 percent grade but may be a maximum of 1:12 (8.3 percent), if hand rails and landings are provided.⁽¹³⁾ Long, steep grades should have level areas at intermittent distances (every 9.1 m (30 ft)), since traversing a steep slope with crutches, artificial limbs, or in a wheelchair is difficult and level areas are needed for the pedestrian to stop and rest. If there are areas where it is impossible to avoid steep grades, an alternative route (such as an elevator in a nearby building) should be provided. However, ADA does not require accommodations in all locations where natural terrain prevents treatment.

Where grades exceed 5 percent, special textures and handrails may be required. Handrails are used by persons in wheelchairs to help pull themselves up and are used by other persons for support. Informational signs, indicating alternative routes or facilities, can be placed at the base of the grade or in a guidebook for the area. Arrangements may be made with the local transit authorities to transport persons with disabilities at a reduced (or no) fare where steep grades or other obstacles prohibit or severely impede access.

Street Furniture

Street furniture, such as benches and bus shelters, should be out of the normal travel path to the extent possible. For greater conspicuity, high-contrast colors, such as red, yellow, and black, are preferable. The following guidelines should be considered in the positioning of street furniture:

- Street furniture (such as awnings, hanging plants, hanging signs, or tree branches) should not hang lower than 2.0 m (6.7 ft) over a walking area.
- No freestanding object or object mounted on a wall or post should have a clear open area under it higher than 0.7 m (2.3 ft) off the ground in order to allow full detection of obstacles by visually impaired cane users.
- No object higher than 0.7 m (2.3 ft) attached to a wall should protrude from that wall more than 0.3 m (1 ft.).
- No protruding object should reduce the clear width of a sidewalk or walkway path to less than 0.9 m (3 ft).

Another common problem for wheelchair users is the placement of street furniture next to on-street parking, which can make exiting a car or lift-equipped vehicle difficult. One remedy is to relocate the street furniture toward the end of the parking space instead of the center, or at the back of the sidewalk furthest from the curb. At least 1.5 m (5 ft) of clear space width along the sidewalk is needed to allow for exiting a vehicle. Other objects, such as streetlight poles, may be more difficult to move, so consideration may be given to relocating the accessible parking space or reserving extra accessible parking spaces.

Pedestrian Pushbuttons

Some individuals may have difficulty operating pedestrian pushbuttons. In some instances, there may be a need to install a larger pushbutton or to change the placement of the pushbutton. Pedestrian pushbuttons should always be easily accessible to individuals in wheelchairs and should be no more than 1.2 m (4 ft) above the sidewalk (see figures 8-10 and 8-11) to be within the reach limits of wheelchair users. The force required to activate the pushbutton should be no greater than 2.3 kilograms (kg) (5 pounds (lb)).

Pedestrian pushbuttons should be located next to the sidewalk landing, the top of the ramp, and adjacent to the appropriate crosswalk ramp. If there are two pushbuttons at a corner (one for each crosswalk), the pushbuttons should, ideally, be located on separate poles and adjacent to their respective ramps to avoid user confusion.

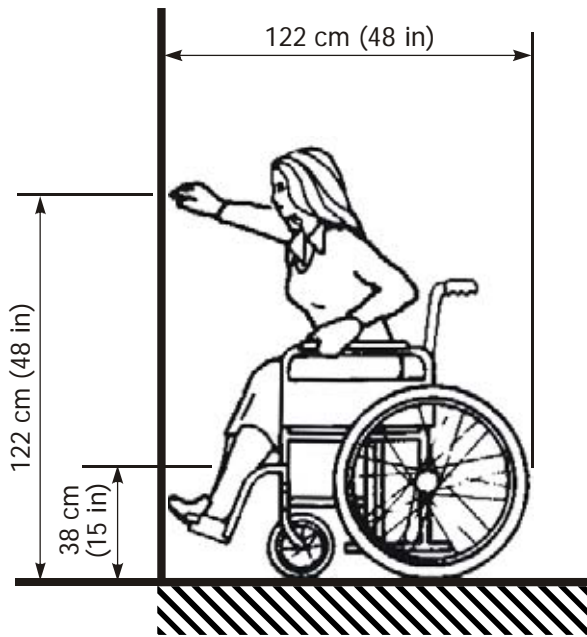

Figure 8-10. Illustration.
High and low forward reach limits.

Source: ADAAG,
<http://www.access-board.gov/adaag/html/adaag.htm>⁽¹²⁾

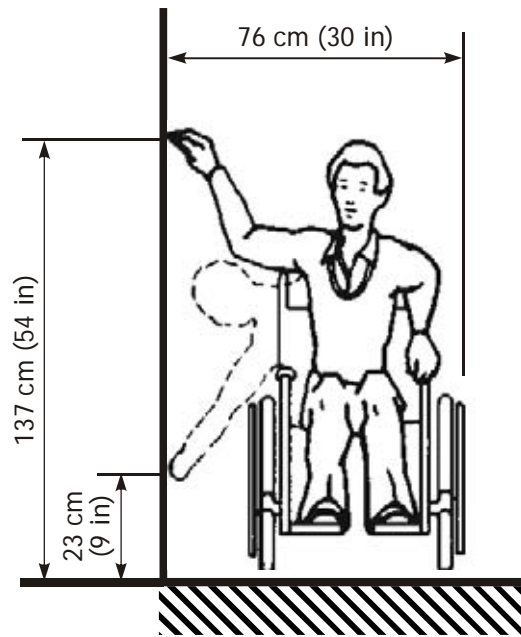

Figure 8-11. Illustration.
High and low side reach limits.

Source: ADAAG,
<http://www.access-board.gov/adaag/html/adaag.htm>⁽¹²⁾

Curb Cuts and Wheelchair Ramps

The single most important design consideration for persons in wheelchairs is to provide curb cuts. New and rebuilt streets with sidewalks should always have curb cuts at all crosswalks. A roll curb (i.e., one with a sloped rather than a vertical curb face) is a barrier and will not allow for wheelchair access. Curb cuts should be at least 1.2 m (4 ft) wide at the base, exclusive of flared sides (see figures 8-12 and 8-13). The flared sides should not exceed a slope of 1:10 (see figures 8-12 and 8-14) or 1:12 if the sidewalk width in front of the curb ramp is less than 1.2 m (4 ft) wide (see figures 8-14 and 8-15). The least possible slope should be used for the ramp, but the maximum slope of the ramp is 1:12 (see figure 8-13).

However, sometimes there is a constrained right-of-way and not enough space to construct a ramp with these dimensions perpendicular to the roadway. In such cases, a ramp should be built from the roadway surface to a midpoint landing that is as flat as possible, and then the rest of the ramp can be constructed from the landing to the sidewalk parallel to the roadway (see figure 8-16). While this method is not the ideal design choice, it is a workable solution in situations with narrow sidewalk space and a limited right-of-way.

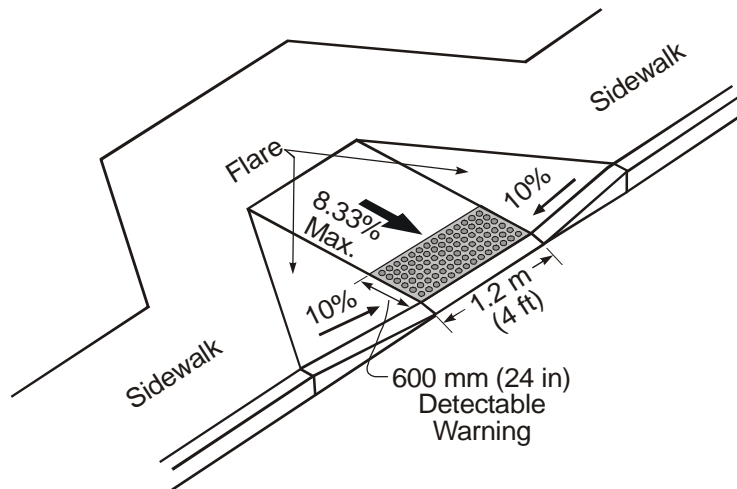

Figure 8-12. Illustration. Curb ramp with sidewalk next to curb.

Source: Adapted from American Association of State Highway and Transportation Officials⁽¹³⁾

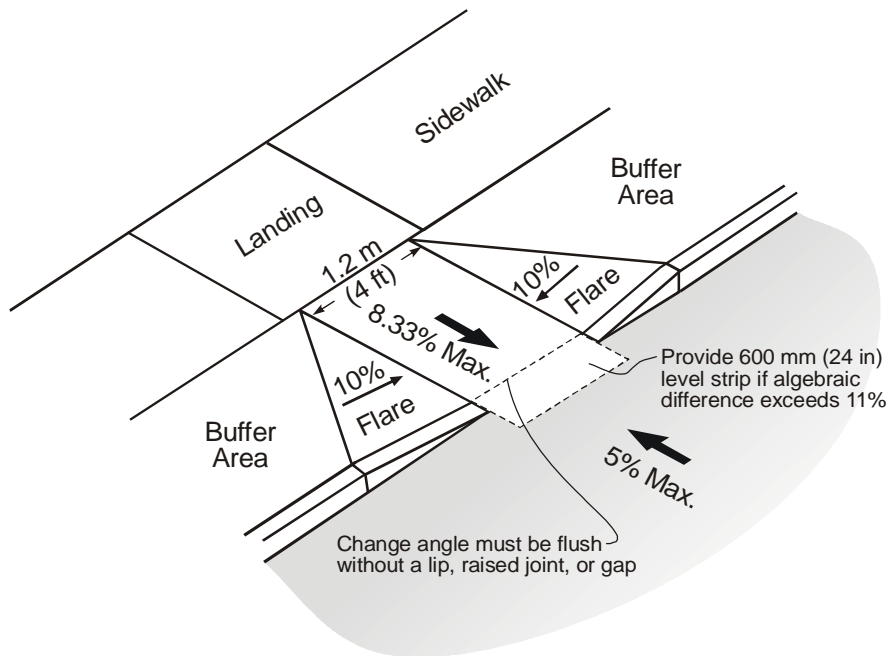

Figure 8-13. Illustration. Measurement of curb ramp slopes and counter slope.

Source: American Association of State Highway and Transportation Officials⁽¹³⁾

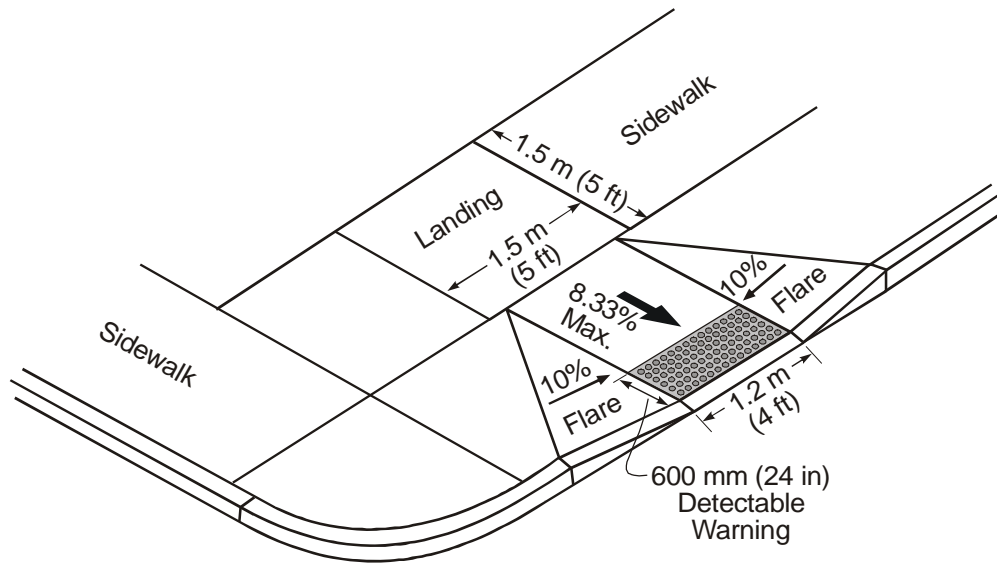

Figure 8-14. Illustration. Sides of curb ramps.

Source: American Association of State Highway and Transportation Officials⁽¹³⁾



Figure 8-15. Photo. Perpendicular curb ramp.



Figure 8-16. Photo. Parallel curb ramp.

It is desirable to provide two curb cuts per corner. Single ramps located in the center of a corner are less desirable than a separate ramp for each crosswalk to accommodate pedestrians with disabilities and should not be built for newly constructed or reconstructed sidewalks. Separate ramps provide greater information to visually impaired pedestrians in street crossings, especially if the ramp is designed to be parallel to the crosswalk. Diagrams (a) and (b) in figure 8-17 have two curb cuts and ramps per corner, both leading the ramp to the center of the marked crosswalk. Diagrams (c) and (d) have only one cut per corner, which leads the ramp to the center of the intersection and would require a ramp user to turn at the bottom of the ramp in order to face the marked crosswalk. For visually impaired pedestrians, it is beneficial to have a ramp leading directly to the crosswalk, rather than the intersection, to help orient them in the proper crossing direction. These also benefit others with mobility limitations such as elderly pedestrians and persons pushing strollers, carts, etc.

Crosswalk markings should be located so that a pedestrian in a wheelchair should not have to leave the crosswalk to enter or exit the street. In some cases, a wider ramp may be used to accommodate pedestrians in wheelchairs.

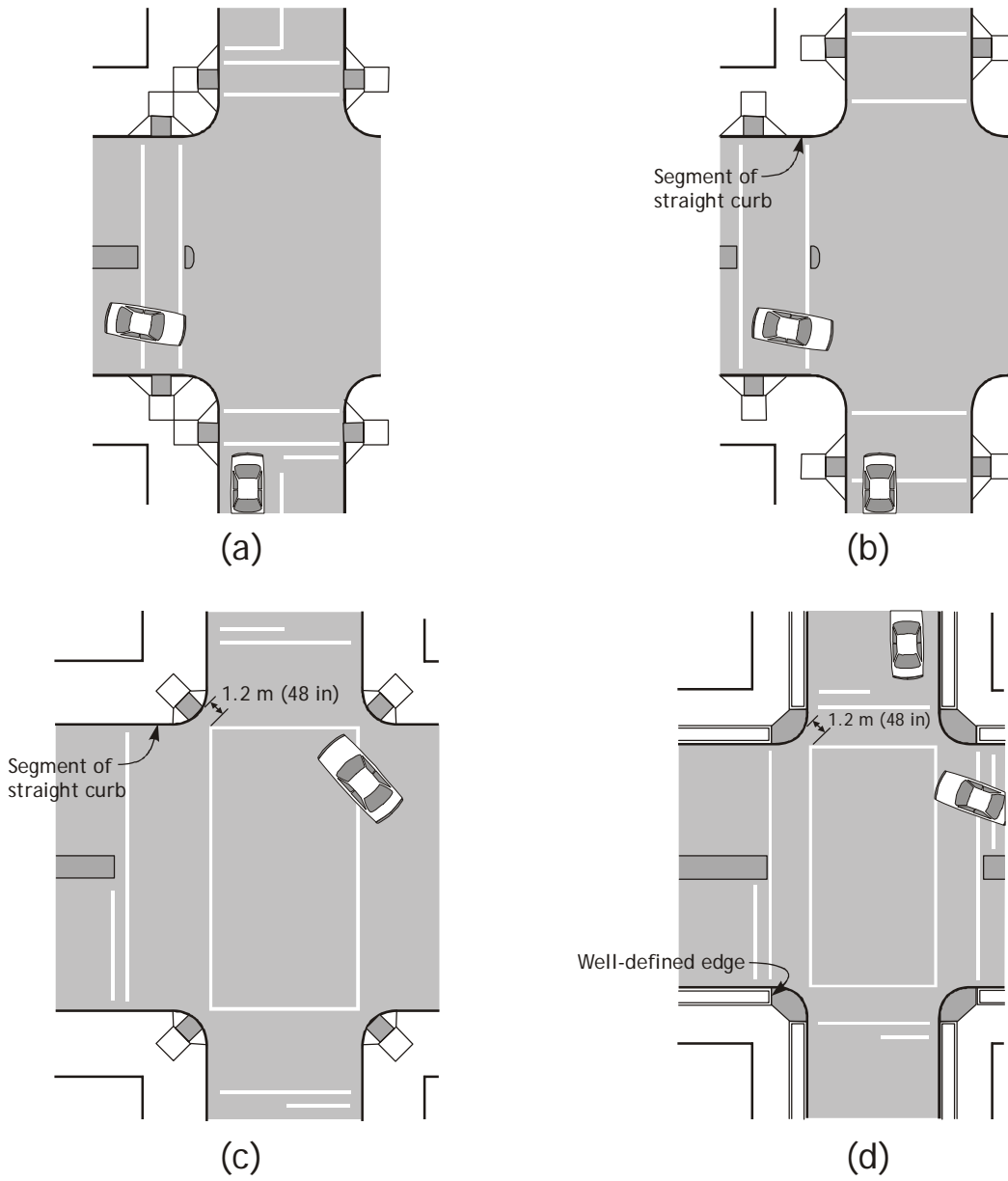

Figure 8-17. Illustration. Curb ramps at marked crossings.

Source: ADAAG, <http://www.access-board.gov/adaag/html/adaag.htm>⁽¹²⁾

The ramps should be flared smooth into the street surface (see figure 8-18). Ramps should be checked periodically to make sure large gaps do not develop between the gutter and street surface. There may be a need to remove accumulations of asphalt at the edge of the curb radius.



Figure 8-18. Photo. A pavement grinding project left an exaggerated lip at this curb cut.

Ramps or cut-through islands should be provided for marked or unmarked crosswalks at median (or frontage road) islands. Cut-throughs should be designed to provide proper drainage and to avoid ponding.

Drainage is important. Standing water can obscure a dropoff or pothole at the base of a ramp and makes the crossing messy. Storm drain inlets should be clear of the crosswalk. If this is not possible, the openings in the grate should be no larger than 1.3 cm (0.5 in) in width.

8.7 Student Exercise

To help you recognize how challenging visual and mobility impairments can be, shadow a pedestrian with a disability to or from home or work, or travel in a wheelchair and then as a blindfolded pedestrian.

For safety, the following rules apply to this activity:

- Document both good and bad design elements and explain how you might improve the facility to accommodate all pedestrians better.
- Always have your protector (partner) with you.
- Only travel in the area designated for this activity.
- Always lean backwards when going down a ramp (wheelchair).
- Always lean forward when going up a ramp (wheelchair).

- The protector should be in front of the wheelchair when going downhill and behind the wheelchair when going uphill.
- Do not hold onto the blind person or push the wheelchair.
- Talk to the blind person to let them know you are there and only warn of dangers (do not direct).

8.8 References and Additional Resources

The references for this lesson are:

1. *Florida Pedestrian Planning and Design Handbook*, Florida Department of Transportation, Tallahassee, FL, April 1999, available online at http://www.dot.state.fl.us/Safety/ped_bike/handbooks_and_research/PEDHBTOC.PDF, accessed April 14, 2003.
2. *Sacramento County Pedestrian Design Guidelines*, chapter 2, draft version, Sacramento, CA, Department of Transportation, April 2003, 2005 draft available online at http://www.sacdot.com/projects/atp_pmp/documents/SacCtyDraftPedestrianDesignGuidelines.pdf.
3. Dewar, R., chapter 18: “Pedestrians and Bicyclists,” *Human Factors in Traffic Safety*, Lawyers & Judges Publishing Company, Tucson, AZ, 2002.
4. MUTCD, USDOT, FHWA, 2003, available online at <http://mutcd.fhwa.dot.gov/>, accessed March 21, 2003.
5. Zegeer, C., *Design and Safety of Pedestrian Facilities—A Recommended Practice of the ITE*, ITE, Washington, DC, March 1998, available online at http://safety.fhwa.dot.gov/ped_bike/docs/designsafety.pdf.
6. Staplin, L., K. Lococo, S. Byington, and D. Harkey, *Guidelines and Recommendations to Accommodate Older Drivers and Pedestrians*, Publication No. FHWA-RD-01-051, FHWA, McLean, VA, May 2001, available online at <http://www.tfhr.gov/humanfac/01105/01-051.pdf>.
7. Dahlstedt, S., *Walking Speeds and Walking Habits of Elderly People*, National Swedish Road and Traffic Research Institute, Stockholm, no date.
8. *Safety of Vulnerable Road Users*, Scientific Expert Group on the Safety of Vulnerable Road Users (RS7), The Organization for Economic Cooperation and Development, Final Report, Publication No. DTSI/DOT/RTR/RS7(98)1/Final, Paris, France, 1998, available online at <http://www.oecd.org/dataoecd/24/4/2103492.pdf>.
9. Roupail, N., J. Hummer, J. Milazzo II, and P. Allen, “Literature Synthesis for Chapter 13, Pedestrians” of the *Highway Capacity Manual*, FHWA, Washington, DC, February 1998.
10. Fruin, John J., *Pedestrian Planning and Design*, Metropolitan Association of Urban Designers and Environmental Planners, Inc., New York, NY, 1971.

11. "About Pedestrians," *Pedestrian Facilities Design Guide*, draft version, Georgia Department of Transportation, Atlanta, GA, available online at http://www.dot.state.ga.us/dot/plan-prog/planning/projects/bicycle/ped_facilities_guide/about_pedestrians.pdf.
12. ADAAG, United States Access Board, 2002, available online at <http://www.access-board.gov/adaag/html/adaag.htm>, accessed January 29, 2004.
13. *AASHTO Guide for the Planning, Design, and Operation of Pedestrian Facilities*, AASHTO, Washington, DC, July 2004.
14. Kockelman, K., L. Heard, Y-J. Kweon, and T.W. Rioux, "Sidewalk Cross-Slope Design: Analysis of Accessibility for Persons with Disabilities," *Transportation Research Record*, TRB, January 2002.

Additional resources for this lesson include:

- Information and guidelines on accessible design for pedestrian facilities can be obtained from United States Access Board, <http://www.access-board.gov/>.

LESSON 9:

WALKWAYS, SIDEWALKS, AND PUBLIC SPACES

9.1 Introduction

No single design feature can ensure that a streetscape will be attractive to pedestrians. Rather, the best places for walking combine many design elements to create streets that feel right to people on foot (see figure 9-1). Street trees, separation from traffic, seating areas, pavement design, lighting, and many other factors should be considered in locations where pedestrian travel is accommodated and encouraged. This lesson provides an overview of these design elements with examples of successful streetscapes throughout the United States. The major sections of this lesson are as follows:

- 9.1 Introduction.
- 9.2 Sidewalk Placement.
- 9.3 Basic Sidewalk Elements.
- 9.4 Summary of Basic Sidewalk Elements.
- 9.5 Ambience, Shade, and Other Sidewalk Enhancements.
- 9.6 Costs and Benefits of Sidewalk.
- 9.7 Public Spaces.
- 9.8 Student Exercise.
- 9.9 References and Additional Resources.



Figure 9-1. Photo. An example of a pedestrian-friendly streetscape.

9.2 Sidewalk Placement

Sidewalks are recommended on both sides of all urban arterial, collector, and most local roadways. Although local codes vary, AASHTO and other national publications insist that separation of the pedestrian from motorized traffic is an essential design feature of a safe and functional roadway.

The AASHTO *Policy on Geometric Design of Highways and Streets* (also called the *Green Book*) does not fully address the issue of sidewalk placement, but in lightly developed areas, the *Green Book* recommends that rights-of-way be preserved on all arterial and collector roadways.⁽¹⁾ While AASHTO and many other organizations suggest that some short sections of local streets can have sidewalks on one side only, the designer should consider that single-side sidewalks can create unwanted motorist/pedestrian conflicts.

Priority Construction of Sidewalks

Many communities, such as Tallahassee, FL, have small (\$250,000), but significant, sidewalk construction funds set aside for community development and pedestrian safety. When prioritizing missing sidewalks, it is important to provide sidewalks to fill gaps on arterials and collectors at the following locations:

- Schools within 0.4 km (0.25 mi).
- All transit stop locations.
- Parks and sports arenas.
- Shopping districts or commercial areas.
- Recreational corridors.
- Retirement homes.
- Medical complexes/hospitals.
- All public buildings.

9.3 Basic Sidewalk Elements

All sidewalks require the following basic ingredients for success:

- Adequate sidewalk width.
- Curbing.
- Border areas and buffers from the travel lane.
- Gentle grades.
- Level cross slopes.
- Well-maintained pavement surfaces.
- Properly designed stairs (if required).
- Adequate corners.
- Clearance distances to walls, street furniture, and other structures.
- Adequate sight distances around corners and at driveways.
- Continuity of the sidewalk system.

Minimum Sidewalk Width

Sidewalks require a minimum width of 1.2 m (4.0 ft) clear width from the back of curb (see lesson 8, section 8.6, for more on design requirements). Sidewalks with less than 1.5m (5ft) in width should have passing spaces at reasonable intervals.⁽²⁾ Walking is a social activity. For any two people to walk together, 1.5 m (5.0 ft) of space is the bare minimum. In some areas, such as near schools, sporting complexes, some parks, and many shopping districts, the minimum width for a sidewalk is 2.4 m (8.0 ft). Thus, any existing 1.2 m (4.0 ft) wide sidewalks (permitted as an *AASHTO Guide for the Planning, Design, and Operation of Pedestrian Facilities (AASHTO Pedestrian Guide)* minimum) may force pedestrians into the roadway in order to pass other pedestrians. Even children walking to school find that a 1.2 m (4.0 ft) width is not adequate.

Desirable Sidewalk Width

The desirable width for a sidewalk is often much greater than that required. Some shopping districts require 3.7, 6.1, 9.1, and even 12.2 m (12, 20, 30, and 40 ft) of width to handle the volumes of pedestrian traffic they encounter. Pennsylvania Avenue in Washington, D.C. has 9.1 m (30 ft) sidewalk sections to handle tour bus operations, K Street in Washington, D.C. has 6.1 m (20 ft) sections to handle transit offloading and commercial activity, and the commercially successful boulevard in Barcelona, Spain, the Paseo de Gracia, has 11.0–14.6 m (36–48 ft) sidewalks in most sections.

Designers must pay close attention to minimums and only use variances below these levels for short sections. On the other side of the width equation, overly ample sidewalk widths are rarely justified. It is essential to work out the peak volumes of transit discharge, the likely commercial appeal of an area, and the influence of large tour buses and other factors when designing public spaces. Chapter 11 of the FHWA *Highway Capacity Manual*, 2000 edition, covers the topics of sidewalk width and pedestrian LOS.⁽³⁾

Designers should also consider the commercial need for outdoor cafes, kiosks, corner gathering spots, and other social uses on sidewalks. Sidewalk widths have not been given sufficient attention by most designers. When working in a commercial area, designers should always consult property owners, chambers of commerce, and landscape architects to make certain that the desired width is realistic. Corner or midblock curb extensions can be used for creating both pedestrian storage space for roadway crossings and social space.

Bridge Sidewalks

Bridge crossings are essential to pedestrians and bicyclists. Whenever possible, the sidewalks should be continued with their full width.

Sidewalks on bridges should be placed to eliminate the possibility of falling into the roadway or over the bridge itself (see figure 9-2). Railings, fences, or some other barrier should be at least 1.1 m (42 in) high to prevent a pedestrian or bicyclist from being able to fall over the edge.⁽⁴⁾



(This picture shows a bicyclist not wearing a helmet. FHWA strongly recommends that all bicyclists wear helmets.)

Figure 9-2. Photo. Bicyclists are often forced to use bridge sidewalks when they are not accommodated in the roadway.

Sidewalks should be placed on both sides of bridges. Under extreme conditions, sidewalks can be used on one side only, but this should only be done when safe crossings can be provided on both ends of the bridge. When sidewalks are placed on only one side, they should be wider in order to accommodate larger volumes of pedestrian traffic.

Rural Sidewalks

Sidewalks along rural roadway sections should be provided as near the right-of-way line as is practicable. If a swale is used, the sidewalk should be placed at the back of the swale. If a guardrail is used, the sidewalk must be at the back of the guardrail. There will be times in near-urban spaces where the placement of sidewalks is not affordable or feasible. Wide paved shoulders on both sides of the roadway will be an appropriate substitute in some cases. However, the potential for growth in near-urban areas requires that rights-of-way be preserved. When sidewalks are placed at the back of the right-of-way, it may be necessary to bring the walkways forward at intersections in order to provide a roadway crossing where it will be anticipated by motorists. Security issues are also important on rural area sidewalks, so street lighting should be given full consideration. This lighting can act as part of the transitional area alerting higher-speed motorists that they are arriving at an urban area.

Border Areas and Buffers

A border area should be provided along streets for safety as well as aesthetic reasons. The border area between the roadway and the right-of-way line should be wide enough to serve several purposes, including the provision of a buffer space between pedestrians and vehicular traffic, sidewalk space, snow storage, an area for placement of underground utilities, and an area for maintainable aesthetic features such as grass or other landscaping (see figure 9-3). The border width may be a minimum of 1.5 m (5 ft), but desirably, it should be 3 m (10 ft) or wider. Wherever practical, an additional obstacle-free buffer width of 3.7 m (12 ft) or more should be provided between the curb and the sidewalk for safety and

environmental enhancement. In residential areas, wider building setback controls can be used to attain these features.⁽¹⁾

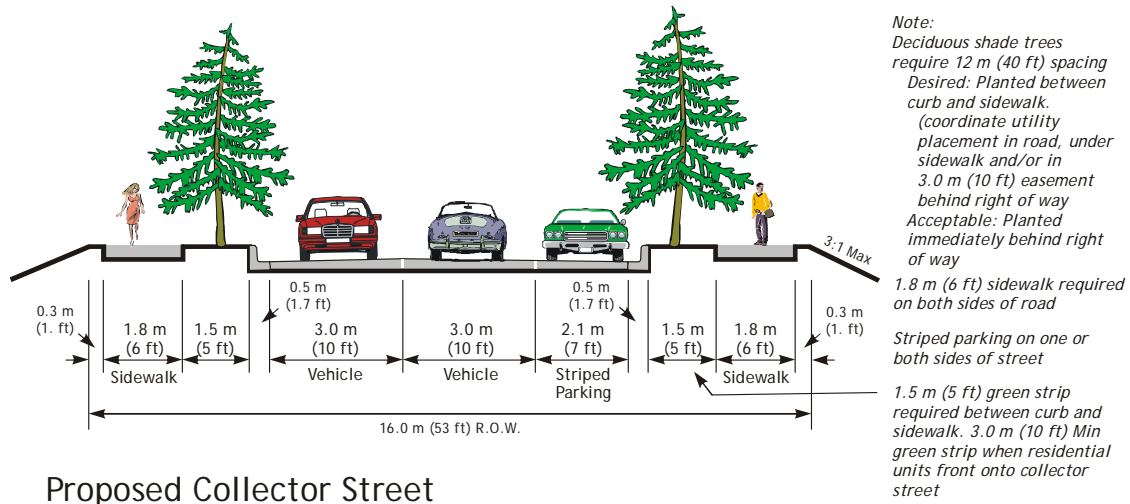

The preferred minimum width for a planting strip is 1.5–2.1 m (5–7 ft). A planting strip this wide provides ample storage room for many utilities. The width provides:

- An essential buffer between an out-of-control motorist and a pedestrian.
- Improved sight distances at driveways.
- Adequate width for landscaping and street trees.

A tree setback from the roadway of 1.2 m (4.0 ft) meets minimum AASHTO standards for fixed objects when a barrier curb is used and motor vehicle speeds are 48 km/h (30 mi/h) or less, and is adequate for most species. The area is ample for most snow storage. When this preferred minimum cannot be achieved, any width, down to 1.2 m (4.0 ft) or even 0.6 m (2.0 ft), is still beneficial.

Planting strips, especially in downtown areas, may be a good location to use paver stones for easy and affordable access to underground utilities. In downtown areas, planting strips are also a convenient location for the swing-width of a door, for placement of parking meters, hydrants, lampposts, and other furniture.

Another way to achieve border width and the needed buffer from traffic is to provide bike lanes. This 1.5 m (5 ft) space creates a minimal safe width to the sidewalk, even when the sidewalk is located at the back of the curb; reduces the effects of noise and splashing; and provides a higher level of general comfort to the pedestrian.

Onstreet parking (see figure 9-4) has two distinct advantages for the pedestrian. First, it creates the needed physical separation from the motorist. Second, onstreet parking has been shown to reduce motorist travel speeds. This creates an environment for safer street crossings.



Figure 9-4. Photo. Parked cars can also serve as a buffer between the sidewalk and the street.

Source: PBIC
Image Library, <http://www.pedbikeimages.org>⁽⁵⁾

On the backside of sidewalks, a minimum width buffer of 0.3 to 0.9 m (1 to 3 ft) is essential, and up to 1.5 m (5 ft) is desired. Without such a buffer, vegetation, walls, buildings, and other objects located on private property encroach on the usable sidewalk space. With just several months of growth, many shrubs will dominate a sidewalk space. This setback is essential, not only to the walking comfort of a pedestrian, but to ensure essential sight lines at each residential and commercial driveway.

Grade

If possible, grades should be limited to no more than 5 percent, and in steeper terrain, grades greater than 8 percent should be avoided. When this is not possible, railings and other aids can be considered to help older adults or those with walking difficulty. The ADA does not require designers to change topography, but only to work within its limitations and constraints. Do not construct any grade that exceeds 8 percent.

Sidewalks must be graded and placed in areas where water will not pond or where large quantities of water will not sheet across. They should also be designed such that level surfaces are maintained across driveways.

Cross Slopes

Cross slopes should be kept to a minimum as well. Lesson 8, section 8.6, describes the cross-slope requirements for sidewalks, ramps, and curb ramps.

Pavement Surfaces

The pavement surface should be well maintained and free from cracks, pooled water, and debris. Although most sidewalks are made of concrete, asphalt can provide a useful surface in some instances.

On trails, joggers and others may prefer asphalt. As a general rule, however, the long life of concrete and the distinct pattern and lighter color are preferred. Paver stones can also be used, and in some applications, they have distinct advantages (see section 9.5 in this lesson). Contrasting colors of pavement surfaces defines the space for pedestrians and motor vehicles.

Stairs

Since falls are common with poorly designed stairs, every effort should be made to create a slip-free, easily detected, well-constructed set of stairs. The following principles apply: Stairs require railings on at least both side, and they need to extend 30.5 cm (12 in) beyond the top and bottom stair. When an especially wide set of stairs is created, such as at transit stations, consider rails on both sides and one or two in midstair areas. Avoid open risers, and use a uniform grade with a constant tread to rise along the stairway length. All steps need to be obvious. Stairs should be lit at night. A minimum stairway width is 106.7 cm (42 in) (to allow two people to pass), but maintaining the sidewalk width is always best. The forward slope should be one percent in order to drain water. Stairs in high nightlife pedestrian centers can be lit both above and at the side. Other alternatives to stairs such as ramps or alternate routes are advisable so that the facility is fully accessible to all pedestrians.

Corners

Management of land on the corner is essential to the successful commercial street. This small public space is used to enhance the corner sight triangle; to permit underground piping of drainage so that street water can be captured on both sides of the crossing; to provide a resting place and telephone; to store pedestrians waiting to cross the roadway; and to provide other pedestrian amenities. Well-designed corners, especially in a downtown or other village-like shopping district can become a focal point for the area. Benches, telephones, newspaper racks, mailboxes, bike racks, and other features help enliven this area (see figure 9-5). Corners are often one of the most secure places on a street. An unbuilt corner, in contrast, erodes the aesthetics of the street and is often a magnet for litter.

Caution should be exercised when adding amenities to corners. Too many amenities or improperly placed ones could reduce sight distances and cause either clutter or driver distraction.



Figure 9-5. Photo. This corner features public telephones and a sitting area that does not encroach on the walkway.

Corner Ramps



Ramps are essential amenities of corners. To access more information on required ramp dimensions and design, go to lesson 8, section 8.6.

Corner Storage Space

Sidewalks also require sufficient storage space at corners so that the predicted volume of pedestrians can gain access to and depart from signalized intersections in an orderly and efficient manner. Table 9-1, adapted from Fruin, provides the amount of space appropriate in a queuing area to the LOS (volume of pedestrians) predicted.⁽⁶⁾

Table 9-1. Corner storage space by pedestrian volumes.

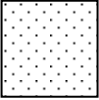
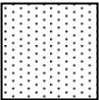
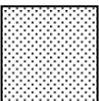
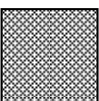
Source: *Pedestrian Planning and Design*⁽⁶⁾

LOS	Average Space per Pedestrian	Description	Volume
A	> 1.2 m ² (13 ft ²)	Standing and free circulation through the queuing area is possible without disturbing others within the queue.	
B	> 0.9 to 1.2 m ² (10 to 13 ft ²)	Standing and partially restricted circulation to avoid disturbing others in the queue is possible.	
C	> 0.6 to 0.9 m ² (6 to 10 ft ²)	Standing and restricted circulation through the queuing area by disturbing others in the queue range is possible; this density is within the range of personal comfort.	
D	> 0.3 to 0.6 m ² (3 to 6 ft ²)	Standing without touching is possible; circulation is severely restricted within the queue and forward movement is only possible as a group; long-term waiting at this density is uncomfortable.	
E	> 0.2 to 0.3 m ² (2 to 3 ft ²)	Standing in physical contact with others is unavoidable; circulation in the queue is not possible; queuing can only be sustained for a short period of time without serious discomfort.	
F	≤ 0.2 m ² (2 ft ²)	Virtually all persons within the queue are standing in direct physical contact with others; this density is extremely uncomfortable; no movement is possible in the queue; there is potential for panic in large crowds at this density.	

Object Clearances and Placement of Street Furniture

Pedestrians feel more comfortable with a clearance from fixed objects such as walls, fences, shrubs, buildings, parked cars, and other features. The desired clearance between the curb and a pedestrian is 0.5 to 0.6 m (1.5 to 2.0 ft), depending on the vegetation planted (see figure 9-6). Allow for this clearance in determining the functional width of a sidewalk. From a wall or fence, the clearance is 0.5 m (1.5 ft), and a building face adds an extra 15.2 cm (6 in) of space required.⁽³⁾

Note that attractive windows in shopping districts create momentary stoppage of curious pedestrians. This is a desired element of a successful street. These window watchers take up about 48.2 to 61.0 cm (19 to 24 in) of space (see lesson 8, section 8.5 for pedestrian space requirements). The remaining sidewalk width will be constrained. This is often desirable on sidewalks not at capacity. But if this stoppage forces pedestrians into the roadway, the sidewalk is too narrow. There should be 0.9 m (3 ft) of clearance provided for building faces with window front displays (see figure 9-6).

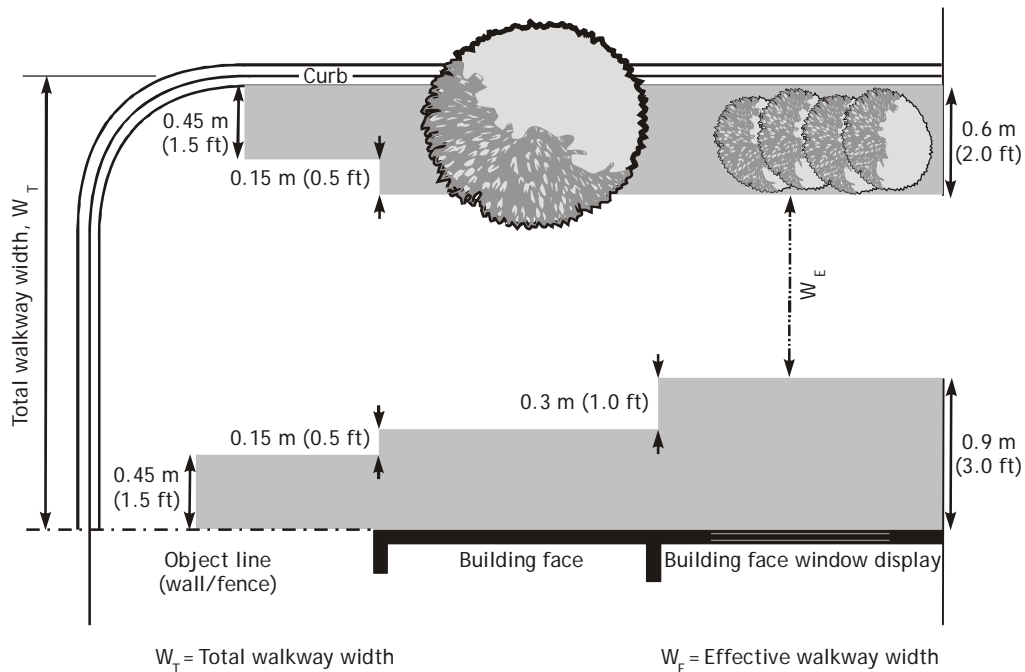

Figure 9-6. Illustration. Example of clearances required to maintain effective walkway width.

Source: *Highway Capacity Manual*⁽³⁾

Newspaper racks, mailboxes, and other street furniture should not encroach into the walking space. Each of these obstacles takes up a different amount of space in the walkway as shown in table 9-2, adapted from Pushkarev and Zupan.⁽⁷⁾ Either place these items in the planting strip, or create a separate storage area behind the sidewalk or in a corner or midblock curb extension. These items must be bolted in place.

Parking meters on a narrow sidewalk create high levels of discomfort. In a retrofit situation, place meters at the back of the walk, or use electronic parking meters every 15.2 or 30.5 m (50 or 100 ft).

Parking garages on commercial district walks are ideally placed away from popular walking streets. If this cannot be done, keep the entrance driveways and their curb radii tight to maximize safety and to minimize the discomfort to pedestrians.

Table 9-2. Preemption of walkway width.

Source: *Urban Space for Pedestrians*⁽⁷⁾

Obstacle	Approximate Width Preempted m (ft)*
Street furniture:	
Light pole	0.8-1.1 (2.5-3.5)
Traffic signal poles and boxes	0.9-1.2 (3.0-4.0)
Fire alarm boxes	0.8-1.1 (2.5-3.5)
Fire hydrants	0.8-0.9 (2.5-3.0)
Traffic signs	0.6-0.8 (2.0-2.5)
Parking meters	0.6 (2.0)
Mailboxes 0.5 by 0.5 m (1.7 ft by 1.7 ft)	1.0-1.1 (3.2-3.7)
Telephone booths 0.8 by 0.8 m (2.7 ft by 2.7 ft)	1.2 (4.0)
Wastebaskets	0.9 (3.0)
Public underground access:	
Subway stairs	1.7-2.1 (5.5-7.0)
Subway ventilation gratings (raised)	1.8+ (6.0+)
Transformer vault ventilation gratings (raised)	1.5+ (5.0+)
Landscaping:	
Trees	0.6-1.2 (2.0-4.0)
Planter boxes	1.5 (5.0)
Commercial uses:	
Newsstands	1.2-4.0 (4.0-13.0)
Vending stands	variable
Advertising displays	variable
Store displays	variable
Sidewalk cafes (two rows of tables)	2.1 (7.0)
Building protrusions:	
Columns	0.8-0.9 (2.5-3.0)
Stoops	0.6-1.8 (2.0-6.0)
Cellar doors	1.5-2.1 (5.0-7.0)
Standpipe connections	0.3 (1.0)
Awning poles	0.8 (2.5)
Truck docks (trucks protruding)	variable
Garage entrance/exit	variable
Driveways	variable

*Note: To account for the avoidance of distance between pedestrians and obstacles, 0.3-0.5 m (1.0-1.5 ft) must be added to the preemption width for individual obstacles. Widths are from curb to edge of object, or building face to edge of object.

Continuity

Sidewalks should be regarded as a transportation system, not unlike roadways and railways, which is connected and continuous. They should not be sporadically placed where convenient, but instead should be provided consistently between all major attractions, trip generators, and other locations where people often walk. When planning and designing sidewalks, gaps in the existing network should be identified and accounted for so that continuity can be established.

9.4 Summary of Basic Sidewalk Elements

Section 9.3 presented many of the basic factors that go into designing a pedestrian-friendly streetscape. Table 9-3 presents a summary of the minimum and desired measurements for some of the design features included in this lesson.

Table 9-3. Minimum and desirable design features.

Design Feature	Minimum Design	Desired Design
Sidewalk width	1.2 m (4 ft) (AASHTO) 1.5 m (5 ft) (ADA) 1.8 m (6 ft) (if at curb face)	2.4, 3.7, or 6.1 m (8,12, or 20 ft), depending on pedestrian traffic volumes
Bridge sidewalks	On one side only (with safe crossings on both sides of the bridge) with full width	On both sides, full width or greater
Rural sidewalks	Wide, paved shoulder where sidewalk not feasible	Sidewalk behind swale and/or guardrail, nearest to right-of-way line, well lit
Border areas and buffers	1.5 to 2.1 m (5 to 7 ft) between traffic lanes; 0.3 to 0.9 m (1 to 3 ft) between private or commercial property	3.0 m (10 ft) or wider between traffic lanes; 1.5 m (5 ft) between private or commercial property
Grade	Normally no more than 5 percent, up to 8 percent by exception	As flat as possible to still allow for drainage
Cross slope	2 percent or less for public rights-of-way, 3 percent or less for outdoor recreation access routes	No more than 2 percent
Pavement surfaces	Usually concrete	Concrete, asphalt, or paver stones
Stairs	106.7 cm (42 in) wide, railings on one side (that extend 45.7 cm (18 in) beyond top and bottom stair)	Uniform grade, well lit (from both the side and above), 1 percent slope, handrails on both sides
Corners	Have 0.9 m (3 ft) wide ramps with landings	Have ramps, queuing space, benches, telephones, and other enlivening features
Clearances and placement of street furniture	None	0.6 m (2 ft) from object
Continuity	None	Interconnected network of sidewalks free from gaps

9.5 Ambience, Shade, and Other Sidewalk Enhancements

The above discussion provides a basis for meeting the most basic needs of a pedestrian. In many parts of a city, much more is essential to create highly successful walking corridors. The following elements are often found to be desirable to achieve robust commercial activity and to encourage added walking versus single-occupant motor vehicle trips. One or two very attractive features create a highly successful block, and one or two highly offending or unsafe conditions can leave one side of the street nearly vacant.

Street Lighting

For both safety and security reasons, most sidewalks require street lighting. Lighting is needed for both lateral movement of pedestrians and for detection by motorists when the pedestrian crosses the roadway. As a general rule, the normal placement of street luminaires, such as cobra heads, provides sufficient lighting to ensure pedestrian movement. In commercial districts, however, it is often important to improve

the level of lighting, especially near ground level. Successful retail centers often use low street lamps in addition to or in lieu of high-angle lamps. Some designs permit both the high-angle highway lamp and the low-angle street lamp on the same pole.

Pedestrians on a pedestrian-oriented street design (shopping district) benefit from three sources of lighting (see figure 9-7). The first is the overall street lighting, the second is the low placement of lamps (usually tungsten) that reach between and below most trees, and the third is the light emitted from stores that line the street. The potential to be victimized keeps many pedestrians from traveling through an area at night. The omission of any one of these lights can result in an undesirable effect and can reduce the desire to walk or shop at night.



Figure 9-7. Photo. Example of pedestrian-oriented street lighting.

Lights are beneficial in all areas having crosswalks or raised channel islands. Lighting can either be direct or be placed to create a silhouette effect. Either treatment aids the motorist in detecting the pedestrian. Thus, lighting from shops, street lamps, and highway luminaires is essential to the success of a commercial district. Even one dark spot along a block may force some pedestrians to the opposite side of the street.

Landscaping

According to the 2001 edition of AASHTO's *A Policy on Geometric Design of Highways and Streets*:⁽¹⁾

Landscaping should be provided for esthetic and erosion control purposes in keeping with the character of the street and its environment. Landscaping should be arranged to permit sufficiently wide, clear, and safe pedestrian walkways. Combinations of turf, shrubs, and trees are desirable in border areas along the roadway. However, care should be exercised to ensure that guidelines for sight distances and clearance to obstructions are observed, especially at intersections.

Landscaping can also be used to partially or fully control crossing points of pedestrians. Low shrubs in commercial areas and near schools are often desirable to channel pedestrians into crosswalks or crossing areas.

Trees

It is hard to imagine any successful walking corridor fully void of trees. The richness of a young or mature canopy of trees cannot be matched by any amount of pavers, colorful walls or other fine architecture, or other features. Although on higher-speed roads (64.4 km/h (40 mi/h) and above), trees are often set at the back of the sidewalk, the most charming streets are those with trees gracing both sides of a walkway. This canopy effect has a quality that brings pedestrians back again and again. If only one side can be achieved, then on low-speed roadways, the trees are best suited when placed between the walkway and the curb. A 1.2-m (4-ft) setback from the curb is required.

In older, pre-WW II neighborhoods, trees were often placed every 7.6, 9.1, or 10.7 m (25, 30, or 35 ft) apart (see figure 9-8). It is essential to keep trees back far enough from the intersection to leave an open view of traffic. The use of curb extensions can often allow trees near the corner.



Figure 9-8. Photo. Street trees provide a desirable pedestrian environment.

Paver Stones

Colorful brick, stone, and even tile ceramics are often used to define corners, to create a mood for a block or commercial district, or to provide information to those with visual impairments. These bricks or pavers need to be set on a concrete pad for maximum life and stability. A stable, slip-resistant, and consistent surface is beneficial to all pedestrians.

Paver stones can also be used successfully in neighborhoods. Denmark is one of many European countries that use concrete 1-m² (10.8-ft²) paver stones as sidewalks. These stones are placed directly over compressed earth. When it is time to place new utilities or make repairs, the paver stones are simply lifted, stacked, and replaced when the work is complete.

Awnings

Retail shops should be encouraged to provide protective awnings to create shade, protection from rain and snow, and to otherwise add color and attractiveness to the street. Awnings are especially important in hot climates on the sunny side of the street.

Kiosks

Small tourist centers, navigational kiosks, and attractive outlets for other information can be handled through small-scale or large-scale kiosks. Well-positioned interpretive kiosks, plaques, and other instructional or historic place markers are beneficial to visitors (see figure 9-9). These areas can serve as safe places for people to meet and can generally help with navigation. However, they should not interrupt the flow of pedestrian traffic.



Figure 9-9. Photo. Including amenities such as kiosks create pedestrian-friendly spaces.

Source: PBIC

Image Library, <http://www.pedbikeimages.org>⁽⁵⁾

9.6 Costs and Benefits of Sidewalks

A typical neighborhood lot sidewalk of 1.5 m (5 ft) and two street border trees raise the cost of an undeveloped lot by one to three percent. In comparison, developed residential lots with sidewalks and trees often show an increased property value of \$3,000 to \$5,000.

The *Pedestrian Facilities Users Guide* states that “the cost for concrete curbs and sidewalks is approximately \$49 per linear meter (\$15 per linear foot) and \$118 per m² (\$11 per ft²) for walkways.”⁽⁸⁾ This means that, for a general design assuming a 61.0 m (200 ft) block and a 2.4-m-wide (8-ft-wide) walkway, the cost for the sidewalk would be about \$20,600. This may seem expensive, but sidewalks have a long lifespan and a limited cost for maintenance, and they increase the value of adjacent properties for long periods of time.

9.7 Public Spaces

In this lesson, the term public spaces refers to the area around a sidewalk that creates part of the greater streetscape environment. Public spaces should be taken into consideration as important design elements of successful streetscapes.

Outdoor Cafes

There are many commercial actions that can help bring back life to a street. Careful regulation of street vendors, outdoor cafes, and other commercial activity, including street entertainers, help enliven a place. The more activity, the better. One successful outdoor cafe helps create more activity and, in time, an entire evening shopping district can be brought to life (see figure 9-10). When outdoor cafes are offered, it is essential to maintain a reasonable walking passageway. The elimination of two or three parking spaces in the street and the addition of a curb extension can often provide the necessary extra space when cafe seating is needed.



Figure 9-10. Photo. An outdoor cafe can add color and life to a street environment.

Alleys and Narrow Streets

Alleys can be cleaned up and made attractive for walking. When properly lit and planned, they can be secure and inviting. Some alleys can be covered over and made into access points for a number of shops. The Bussy Place in Boston was an inhospitable alley between buildings. Now with a roof overhead and a colorful interior with escalators, this alley is the grand entry to a number of successful downtown shops. Other alleys become attractive places for outdoor cafes, kiosks, and small shops (see figure 9-11).



Figure 9-11. Photo. Alleys can be made attractive and can serve as access points to shops.

Victoria, on Vancouver Island, British Columbia, has more than 30 alleys that channel a major portion of its pedestrian traffic between colorful buildings and quaint shops. Some alleys that were originally hardwood cobbles are now polished and provide a true walk through history.

The expansion of a midblock set of crossings can help make these alleyways a prime commercial route and can lessen some of the pedestrian activity on surrounding main roads.

Play Areas and Public Art

Public play areas and interactive art can help enliven a corner or central plaza. One especially creative linear space in Norway provided a fence and a 12.2-m-long (40-ft-long) jumping box. Children were invited to see how far they could jump, and compare their jump with record holders, kangaroos, grasshoppers, dogs, and other critters.

Pedestrian Streets, Transit Streets, and Pedestrian Malls

A number of European cities are reclaiming streets (see figure 9-12). Cars still have access to many of these streets before 10 a.m. and after midnight. Other streets in the U.S. East and West are being converted to transit and pedestrian streets (e.g., the 15th Street Mall in Denver, CO). These conversions must be made with a master plan so that traffic flow and pedestrian movements are fully accommodated. There are many streets in America, however, that have been temporarily converted to pedestrian streets and later, following a lack of use, were then converted back to traffic. In many instances, it has not proven possible to generate enough pedestrian traffic to keep a street alive. Under these conditions, the presence of onstreet auto traffic creates a sense of security for the pedestrian.



Figure 9-12. Photo. Some European streets have been redeveloped as pedestrian malls.

Pedestrian Plazas

Many plazas constructed in the recent past have been too large and uncomfortable for pedestrians, serving more to enhance the image of the building on the lot. Some of these are products of zoning laws that encouraged plaza construction in exchange for increased building height. However, bonus systems have not ensured that the public space will actually be a public benefit. Decisions have been based on inches and feet instead of on activity, use, or orientation. The result has been a number of plazas with problems: some are windswept; others are on the shady side of buildings; still others break the continuity of shopping streets, or are inaccessible because of grade changes. Most are without benches, planters, cover, shops, or other pedestrian comforts. To be comfortable, large spaces should be divided into smaller ones. Landscaping, benches, and wind and rain protection should be provided, and shopping and eating should be made accessible.

The appearance of a crowd in a pedestrian mall provides a sense of interest. It is usually better to be a bit crowded than to be too open and to provide many smaller spaces instead of a few large ones (see figure 9-13). It is better to have places to sit, planters, and other conveniences for pedestrians than to have a clean, simple, and architectural space. It is better to have windows for browsing and stores adjacent to the plaza space, with cross-circulation between different uses than to have the plaza serve one use. Having retailers border the plaza is better than offices. And, finally, the plaza should be a part of the sidewalk instead of separated from the sidewalk by walls.



Figure 9-13. Photo. Small protected spaces provide separation from noise and traffic.

Where is the best place for a plaza? Plazas ideally should be located in places with good sun and little wind exposure, in places that are protected from traffic noise, and in areas that are easily accessible from streets and shops. A plaza should have a center as well as several subcenters.

The planner should inventory for spaces that can be used for plazas, especially small ones. Appropriate spaces include: space where buildings may be demolished and new ones constructed, vacant land, or streets that may be closed to traffic or may connect to parking.

New stores can sometimes be set back 2.4–3.0 m (8–10 ft) from the street to allow plaza space in exchange for increased density.

Some suggestions for planners and developers of plazas include the following:

- Limit plaza size to create small, human-scaled spaces. A maximum size of 232.3 m² (2,500 ft²) is appropriate, with several small plazas being better than one large one.
- Enclose a plaza on one or two sides.
- Plan for at least 20 percent of the plaza to be landscaped.
- Provide seating in the sun and make it readily accessible to the public.
- Also provide seating in the shade and make it accessible to the public.
- Consider providing rain shelters.

- Develop shops and stores along the plazas, excluding large banks, travel agents, and offices that attract few pedestrians.
- Do not use large expanses of blank wall.
- Plan for prevailing sun angles and climatic conditions, using as a rule of thumb a minimum of 20 percent of daily sunshine hours on March 21.
- Encourage the use of bandstands, public display areas, outdoor dining space, skating rinks, and other features which attract crowds. In cold or rainy areas, a covered galleria would benefit pedestrians more than an open plaza.
- Integrate indoor and outdoor space to make it more useful. Plan spaces to be small and informal in character and quality so as to be inviting, comfortable, and not oppressive.
- Avoid sunken plazas, since access is difficult and people feel uncomfortable in them. Keep them level or just slightly below sidewalk grade. For instance, at Rockefeller Center in New York City, NY the lower level originally had shops. These failed and were converted to the now famous ice skating rink. Most people view the rink from above, while only users go below.
- Avoid architectural and geometrical bench arrangements. Instead, consider where and how most people prefer to sit. One reason so-called undesirables frequent many plazas is that benches are not used by pedestrians. Movable chairs, heavy enough not to be stolen, but light enough to move, are recommended so that people can choose where they want to sit and what arrangement they prefer.

9.8 Student Exercise

Part 1

Choose an existing public space that currently does not encourage walking and redesign it to better accommodate pedestrians. Your plan should be developed at a conceptual level. You should prepare a plan view drawing with enough information to identify major existing features, proposed improvements, and impacts. Profile and cross-section view drawings are also helpful in presenting particular details required to construct your proposed improvements. Aerial photographs and U.S. Geological Survey topographic maps often provide a good background for overlaying proposed improvements.

Part 2

Conduct a pedestrian capacity analysis for the Piedmont Park case study location (as described in the student exercise in lesson 3, section 3.12) using procedures described in the *Highway Capacity Manual*.⁽³⁾ The four major park entrances, as indicated on the Site Location Map, should be evaluated to determine the pedestrian LOS. In order to conduct this evaluation, the following should be assumed:

- Expand 15-minute pedestrian counts included in the park usage data to represent hourly volumes.
- All of the pedestrian volumes at each of the four entrances access the park on existing 1.5-m-wide (5-ft-wide) sidewalks.

Establish and document other assumptions as necessary in order to conduct the LOS analysis. Be sure to evaluate the sensitivity of values related to your assumptions.

Determine the existing LOS for pedestrians at the four major park entrances. Do the sidewalks need to be widened? In addition, evaluate pedestrian LOS under the following scenarios:

- Average weekday pedestrian traffic is anticipated to double in 5 years. Will 1.5-m-wide (5-ft-wide) sidewalks be adequate?
- Special events will generate pedestrian volumes five times those measured for an average weekday.

9.9 References and Additional Resources

The references for this lesson are:

1. *A Policy on Geometric Design of Highways and Streets*, 5th ed., AASHTO, Washington, DC, 2004.
2. *AASHTO Guide for the Planning, Design, and Operation of Pedestrian Facilities*, AASHTO, Washington, DC, July 2004.
3. *Highway Capacity Manual*, TRB, National Research Council, Washington, DC, 2000.
4. *Guide for the Development of Bicycle Facilities*, AASHTO, Washington, DC, 1999.
5. Image Library, PBIC, available online at <http://www.pedbikeimages.org>, accessed May 6, 2004.
6. Fruin, J., *Pedestrian Planning and Design*, Metropolitan Association of Urban Designers and Environmental Planners, New York, NY, 1971.
7. Pushkarev, B., *Urban Space for Pedestrians*, MIT Press, Cambridge, MA, 1976.
8. Zegeer, C.V., C. Seiderman, P. Lagerwey, M. Cynecki, M. Ronkin, and R. Schneider, *Pedestrian Facilities Users Guide—Providing Safety and Mobility*, Publication No. FHWA-RD-01-102, FHWA, McLean, VA, March 2002.

Additional resources for this lesson include:

- *Design and Safety of Pedestrian Facilities—A Recommended Practice of the ITE*, ITE, 1998, available online at http://safety.fhwa.dot.gov/ped_bike/docs/designsafety.pdf.
- *Designing Sidewalks and Trails for Access: Review of Existing Guidelines and Practices*, FHWA, Washington, DC, July 1999, available online at <http://www.fhwa.dot.gov/environment/sidewalks/index.htm>.
- *Designing Sidewalks and Trails for Access: Review of Existing Guidelines and Best Practices*, Design Guide FHWA, Washington, DC, September 2001, available online at <http://www.fhwa.dot.gov/environment/sidewalk2/index.htm>.
- *Florida Pedestrian Planning and Design Handbook*, Florida Department of Transportation, Tallahassee, FL, 1997, available online at http://www.dot.state.fl.us/Safety/ped_bike/handbooks_and_research/PEDHBTOC.PDF, accessed April 14, 2003.

- *Oregon Bicycle and Pedestrian Plan*, Oregon Department of Transportation, Salem, OR, June 1995.
- Untermann, Richard K., *Accommodating the Pedestrian*, Van Nostrand Reinhold Company, Inc., New York, NY, 1984.

LESSON 10:

PEDESTRIAN FACILITY SIGNING AND PAVEMENT MARKINGS

10.1 Introduction

Traffic engineers use a wide variety of road signs and pavement markings. Some are used to alert motorists to pedestrian activity and to direct pedestrians to defined crossings. Problems are created, however, when pedestrians assume that signs and paint will protect them from cars. Drivers, on the other hand, often ignore pedestrian signs and markings because they seldom see many pedestrians. As a result, signs and paint may lull pedestrians into a false sense of security.

This lesson provides an overall philosophy for the use of signs and pavement markings, as well as details on how these traffic control measures should be employed. Crosswalk markings at intersections are covered in more detail in lesson 11. The major sections of this lesson are as follows:

- 10.1 Introduction.
- 10.2 Background.
- 10.3 Planning and Design Considerations.
- 10.4 Regulatory Signs.
- 10.5 Warning Signs.
- 10.6 Directional Signs.
- 10.7 Pavement Word and Symbol Markings.
- 10.8 Crosswalk Markings.
- 10.9 ITS Technology.
- 10.10 Student Exercise.
- 10.11 References and Additional Resources.

10.2 Background

Signing is governed by the FHWA's MUTCD, which provides specifications on the design and placement of traffic control signs installed within public rights-of-way.⁽¹⁾ The MUTCD encourages a conservative use of signs (sections 2A-1, 2A-6, 2B-1, and 2C-1). Signs should only be installed when they fulfill a need based on an engineering study or engineering judgment (see figure 10-1). The prevailing thinking among traffic engineers is that overuse of traffic control signs leads to disrespect of signs.



Figure 10-1. Photo. The sign and crosswalk markings at this midblock crossing alert drivers to pedestrians going to school.

Source: PBIC

Image Library, <http://www.pedbikeimages.org>⁽²⁾

Used judiciously and located with consistency, signs and markings can be effective. Jurisdictions should develop clear guidelines for use and should avoid excessive reliance on signs and paint to control motorist behavior. This may mean altering and/or relocating existing signs and markings. It may be best to eliminate markings and signs that have proven to be ineffective or harmful to pedestrian safety. There is ongoing debate and studies are in progress to determine whether markings (especially written messages) improve pedestrian safety, whether crosswalks are useful at midblock locations, and whether signs contribute to visual overload for motorists and breed disrespect for messages.

10.3 Planning and Design Considerations

MUTCD outlines guidelines governing signs and pavement markings. At the same time, it does not prohibit creative regulatory design.

MUTCD does not define criteria for crosswalk location or striping options. “Crosswalks should be marked at all intersections where there is substantial conflict between vehicular and pedestrian movements.” Much is left to engineering judgment to determine what is “substantial.” As a result, there is leeway in adapting guidelines to specific signing and marking policy needs.

Colors for signs and markings must conform to the color schedule recommended by MUTCD to promote uniformity and understanding from jurisdiction to jurisdiction. For the background color of signs, use:

- YELLOW—General warning.
- RED—Stop or prohibition.

- BLUE—Service guidance.
- GREEN—Indicates movement permitted or directional guidance.
- BROWN—Public recreation and scenic guidance.
- ORANGE—Construction and maintenance warning.
- BLACK—Regulation.
- WHITE—Regulation.

For pavement markings, use:

- YELLOW—Centerline stripes which delineate opposing directions of traffic.
- WHITE—All other pavement stripes and markings, including edge stripes, lane markings, and crosswalks.

10.4 Regulatory Signs

These signs are used to inform motorists or pedestrians of a legal requirement and should only be used when the legal requirement is not otherwise apparent. They are generally rectangular in shape, usually consisting of a black legend on a white background, and shall be reflectorized or illuminated. Many motorist signs, including stop signs, yield signs, turn restrictions, and speed limits, have a direct or indirect impact on pedestrians.

The NO TURN ON RED (R10-11a) sign may be used in some instances to facilitate pedestrian movements. MUTCD lists six conditions when no turn on red may be considered, three of which are directly related to pedestrians or signal timing for pedestrians. Considerable controversy has arisen regarding pedestrian safety implications and right-turn-on-red operations, ranging from a study by Zador, which indicated a significant increase in pedestrian crashes where right-turn-on-red movements are allowed, to studies by AASHTO and McGee, which concluded that right-turn-on-red movements do not create a pedestrian safety problem.^(3,4,5)

The use of NO TURN ON RED signs at an intersection should be evaluated on a case-by-case basis. Less restrictive alternatives should be considered in lieu of NO TURN ON RED. Also, supplementary signs, such as WHEN PEDESTRIANS ARE PRESENT or WHEN CHILDREN ARE PRESENT may be placed below the NO TURN ON RED sign.

There are occasions when no-turn-on-red restrictions are beneficial, and specific recommendations relating to pedestrians include:

- Part-time restrictions should be discouraged; however, they are preferable to full-time prohibitions when the need only occurs for a short period of time.
- Universal prohibitions at school crossings should not be made, but rather restrictions should be sensitive to special problems of pedestrian conflicts, such as the unpredictable behavior of children and problems of the elderly and persons with disabilities. Pedestrian volume, as such, should not be the only criterion for prohibiting right-turn-on-red movements.

There are a number of regulatory signs directed at pedestrians, which include:

- Pedestrians prohibited signs (R5-10a, R5-10b, R5-10c, and R9-3a) to prohibit pedestrian entry at freeway ramps.

- Pedestrian crossing signs (R9-2, R9-3a, and R9-3b), which restrict crossings at less safe locations and divert pedestrians to optimal crossing locations at signalized intersections (see figure 10-2). Various alternatives include the USE CROSSWALK (with supplemental arrow) sign, which may be used at signalized intersection legs with high conflicting turning movements or at midblock locations directing pedestrians to use an adjacent signal or crosswalk (see figure 10-3). The signs have most applicability in front of schools or other buildings that generate significant pedestrian volumes.

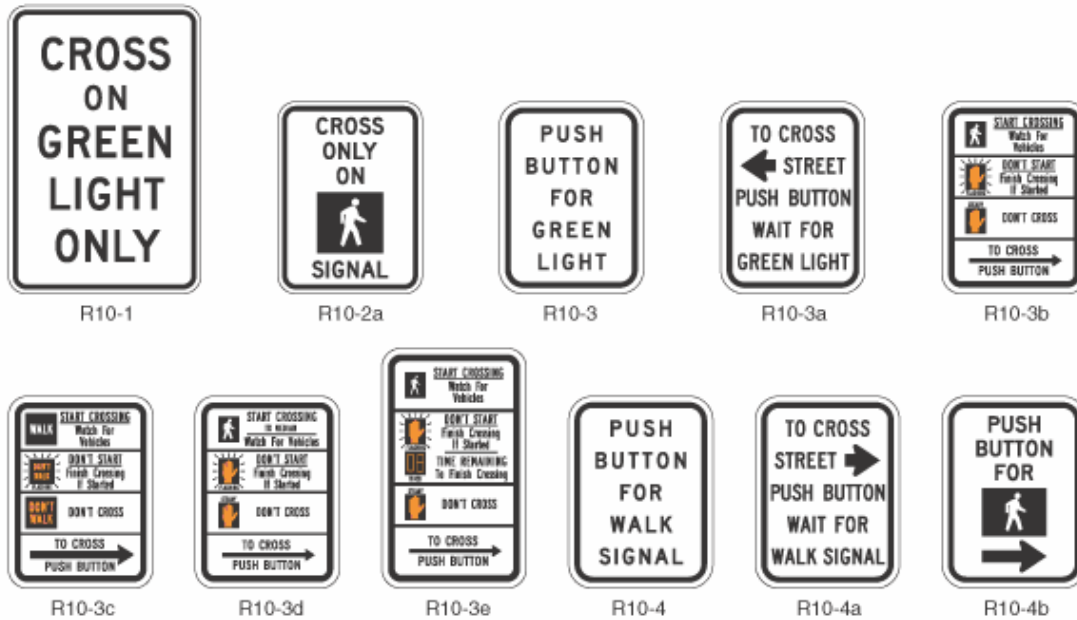

Figure 10-2. Photo. Pedestrian crossing signs.

Source: MUTCD⁽¹⁾



Figure 10-3. Photo. Pedestrians are restricted from continuing straight and are encouraged to cross left to avoid a traffic merge lane.

- Traffic signal signs (R10-1 through R10-4), which include the pedestrian pushbutton signs or other signs at signals directing pedestrians to cross only on the green light or WALK signal. Pedestrian pushbutton signs should be used at all pedestrian-actuated signals. It is helpful to provide guidance to indicate which street the button is for (either with arrows or street names). The signs should be located adjacent to the pushbutton and the pushbuttons should be accessible to pedestrians with disabilities.

Other signs may be used for pedestrians at traffic signals to define the meaning of the WALK, DON'T WALK, and flashing DON'T WALK signal indications (see figure 10-4). In MUTCD, the signs R10-3a, b, c, and d help define crossing signal indications. The top section shows a walking person symbol, labeled STEADY, or the word WALK to the left of the words START CROSSING. The next section shows an orange caution symbol of an upraised hand with the palm facing the viewer, labeled FLASHING, or the words DON'T WALK to the left of the text "DON'T START FINISH CROSSING IF STARTED" on three lines. The third section shows an orange caution symbol of an upraised hand with the palm facing the viewer, labeled STEADY, to the left of the words DON'T CROSS or PEDESTRIANS SHOULD NOT BE IN CROSSWALK. These signs are generally located near the pushbuttons used to activate the crosswalk signal.



Figure 10-4. Photo. Variation of R10-3b regulatory crossing sign.

Source: PBIC Image Library, <http://www.pedbikeimages.org>⁽²⁾

The decision to use these signs (or alternatively, stickers mounted directly on the signal pole) is strictly an engineering judgment and is primarily for educational purposes. As such, their use may be more helpful near schools and areas with concentrations of elderly pedestrians—two high-risk areas. This information may also be effectively converted into brochures for distribution and ongoing educational purposes.

10.5 Warning Signs

Warning signs are used to inform unfamiliar motorists/pedestrians of unusual or unexpected conditions. Warning signs predominantly fall under the permissive category (“may” condition), and when used, should be placed to provide adequate response times. Warning signs are generally diamond-shaped with black letters or drawings on a yellow background and shall be reflectorized or illuminated. Overuse of warning signs breeds disrespect and should be avoided.

The warning sign predominantly used to warn motorists of possible pedestrian conflicts is the Pedestrian Crossing sign (W11-2) (see figure 10-5). This sign should be installed in advance of midblock crosswalks

or other locations where pedestrians may not be expected to cross. This significantly minimizes their use at most urban intersections since pedestrian crossings are an expected occurrence. This sign may also be selectively used in advance of high-volume pedestrian crossing locations to add emphasis to the crosswalk. The advance pedestrian crossing sign provides more advance warning to motorists than crosswalk markings, and on some occasions, may be used when crosswalk markings do not exist. Where there are multiple crossing locations that cannot be concentrated to a single location, a supplemental distance plate may be used (NEXT XX FEET). The advance pedestrian crossing signs should not be mounted with another warning sign (except for a supplemental distance sign or an advisory speed plate) or regulatory sign (except for NO PARKING signs) to avoid information overload and to allow for an improved driver response. When placing signs, care should be taken in relation to other signs to avoid sign clutter and to allow adequate motorist response. The MUTCD specifies a 76- by 76-cm (30- by 30-in) sign size. However, it may be helpful to use a larger [91- by 91-cm (36- by 36-in)] sign on higher speed or wider arterial streets.



Figure 10-5. Photo. This pedestrian crossing sign is fluorescent yellow green (FYG), allowing it to be more visible.

At the actual location of the pedestrian crossing, the pedestrian crossing sign (W11-2) is used but supplemented with a black-on-yellow diagonally downward pointing arrow plaque (W16-7p). This combination of pedestrian crossing sign and supplemental arrow plaque is intended to indicate the pedestrian crossing location.

The Playground sign (W15-1) may be used in advance of a designated children's play area to warn motorists of a potentially high concentration of young children. This sign should generally not be needed on local or residential streets where children are expected. Furthermore, play areas should not be located adjacent to high-speed major or arterial streets, or if so, should be fenced off to prevent children from darting into the street.

According to the ITE publication, *Traffic Control Devices Handbook*, CAUTION—CHILDREN AT PLAY or SLOW CHILDREN signs should not be used since they may encourage children to play in the street and may encourage parents to be less vigilant.⁽⁶⁾ Such signs also provide no guidance to motorists as to a safe speed, and the sign has no legal basis for determining what a motorist should do. Furthermore, motorists should expect children to be at play in all residential areas, and the lack of signing on some

streets may indicate otherwise. The signs are unenforceable and act as another roadside obstacle to pedestrians and errant motorists. Use of these nonstandard signs may also imply that the involved jurisdiction approves of streets as playgrounds, which may result in the jurisdiction being vulnerable to tort liability.

School Warning signs include the advance school crossing signs (S1-1), the school crossing sign (S2-1), SCHOOL BUS STOP AHEAD (S3-1) sign, and others. School-related traffic control devices are discussed in detail in part VII (“Traffic Controls for School Areas”) of MUTCD.⁽¹⁾ A reduced speed limit sign with flashing lights can be installed ahead of the actual crossing (see figure 10-6). The lights are set to flash during school hours, alerting drivers that a lower speed limit is in effect when the flashers are operating. Another sign and light combination is SCHOOL SPEED LIMIT XX, where the speed limit is illuminated during school hours.



Figure 10-6. Photo. Flashing lights, school crossing signs, and a low speed limit gives motorists plenty of warning of the crossing area ahead.

MUTCD allows for the development of other specialty warning signs based on engineering judgment for unique conditions. These signs can be designed to alert unfamiliar motorists or pedestrians of unexpected conditions and should follow the general criteria for the design of warning signs. Their use should be minimized to retain effectiveness and should be based on engineering judgment.

10.6 Directional Signs

Directional signs for pedestrians are intended to assist people who are new to the area or to assist residents who may not know the most direct route to a destination by foot. Use distances meaningful to pedestrians, such as the number of blocks or average walking time.

10.7 Pavement Word and Symbol Markings

MUTCD allows for the use of pavement word and symbol markings such as SCHOOL XING or PED XING, as motorist warning devices (MUTCD, Section 3B-20). These may be helpful on high-volume or high-speed streets with unusual geometrics (such as vertical or horizontal curves) in advance of a

pedestrian crossing area. Markings should be white and placed to provide an adequate motorist response. Their use should be kept to a minimum to retain effectiveness. Consideration should be given to snow conditions that may obliterate the markings during portions of the year in some regions of the country and also to the agency's ability to maintain these pavement markings. If used, the word or symbol markings should generally be used in each approach lane (except for the SCHOOL message).

Some agencies have also attempted to communicate with pedestrians by using pavement word markings such as LOOK BOTH WAYS or other symbols to encourage pedestrians to look for vehicles and to enter the road cautiously (see figure 10-7).



Figure 10-7. Photo. “Look Right” or “Look Left” is painted on the street next to the curb in the United Kingdom.

All pavement word and symbol markings require periodic maintenance and replacement after resurfacing. If such markings are used, it is advisable to maintain an inventory of stencils for periodic checking and refurbishment.

10.8 Crosswalk Markings

Here is an excerpt from MUTCD regarding the use of crosswalk markings:⁽¹⁾

Crosswalk markings provide guidance for pedestrians who are crossing roadways by defining and delineating paths on approaches to and within signalized intersections, and on approaches to other intersections where traffic stops. Crosswalk markings also serve to alert road users of a pedestrian crossing point across roadways not controlled by highway traffic signals or STOP signs. At nonintersection locations, crosswalk markings legally establish the crosswalk.

Table 10-1 presents some minimum and maximum design requirements for crosswalk pavement markings. Below are some additional MUTCD guidelines for crosswalk installation:

- Crosswalk lines, if used on both sides of the crosswalk, should extend across the full width of pavement or to the edge of the intersecting crosswalk to discourage diagonal walking between crosswalks.

- Crosswalks should be marked at all intersections where there is substantial conflict between vehicular and pedestrian movements.
- Marked crosswalks also should be provided at other appropriate points of pedestrian concentration, such as at loading islands, midblock pedestrian crossings, or where pedestrians could not otherwise recognize the proper place to cross.
- Crosswalk lines should not be used indiscriminately. An engineering study should be performed before they are installed at locations away from highway traffic signals or STOP signs.
- Because nonintersection pedestrian crossings are generally unexpected by the road user, warning signs should be installed and adequate visibility should be provided by parking prohibitions.
- For added visibility, the area of the crosswalk may be marked with white diagonal lines at a 45-degree angle to the line of the crosswalk or with white longitudinal lines parallel to traffic flow.
- When diagonal or longitudinal lines are used to mark a crosswalk, the transverse crosswalk lines may be omitted. This type of marking may be used at locations where substantial numbers of pedestrians cross without any other traffic control device, at locations where physical conditions are such that added visibility of the crosswalk is desired, or at places where a pedestrian crosswalk might not be expected.
- The marking design should avoid the wheel paths.

Table 10-1. Design requirements for crosswalk pavement markings.

Treatment	Minimum Design Requirements	Maximum Design Requirements
Solid white transverse crosswalk lines	15.0-cm (6-in) line width 1.8-m (6-ft) gap between lines (crosswalk width)	61.0-cm (24-in) line width No maximum crosswalk width
Diagonal or longitudinal lines without transverse lines	1.8-m (6-ft) crosswalk width 30.5-cm (12-in) line width 30.5-cm (12-in) spacing of lines	No maximum crosswalk width 61.0-cm (24-in) line width 1.5-m (5-ft) spacing of lines (not to exceed 2.5 times the line width)

Three styles of crosswalk markings are shown at a roadway intersection in figure 10-8: two parallel solid white lines (transverse lines) at the top of the figure, solid white diagonal lines between two parallel solid white lines on the left side, and a series of closely spaced solid white lines (longitudinal lines) placed at the intersection parallel to the direction of travel on the bottom side of the figure. Figure 10-9 shows examples of these and other marking patterns typically used and the common names they go by.

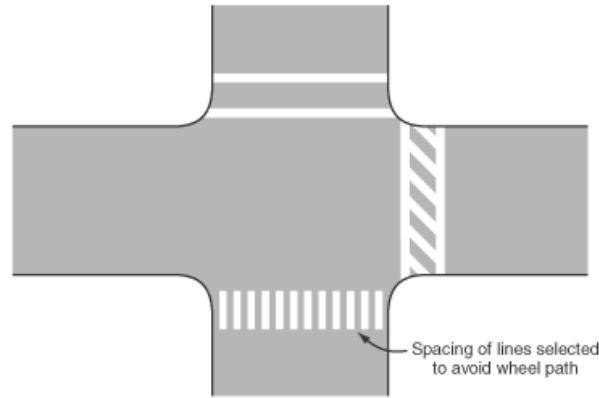

Figure 10-8. Illustration. An intersection with examples of crosswalk markings.

Source: MUTCD⁽¹⁾

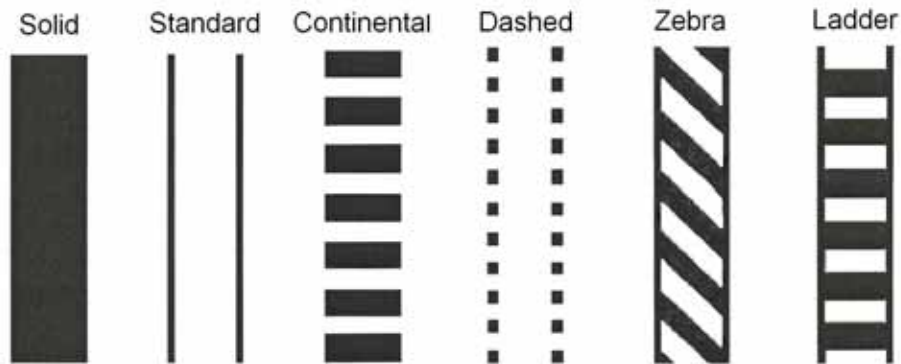

Figure 10-9. Illustration. Common crosswalk marking patterns.

Source: *Safety Effects of Marked versus Unmarked Crosswalks at Uncontrolled Locations*⁽⁷⁾

Marked Versus Unmarked Crosswalks

In the United States, there has been considerable controversy concerning marked crosswalks and whether they increase or decrease pedestrian safety at uncontrolled crossing locations (i.e., intersections or midblock locations with no traffic signals or stop signs on the main road approach). Some believe that marked crosswalks enhance the visibility, safety, and mobility of pedestrians, while others think that they generate overly confident feelings of safety which may cause pedestrians to be more vulnerable to collisions with motor vehicles.

Zegeer, et al., performed a study to determine which types of uncontrolled locations merited a marked crosswalk and which ones would require more treatment in order to provide a safe crossing for pedestrians.⁽⁷⁾ The study revealed that “under no condition was the presence of a marked crosswalk alone at an uncontrolled location associated with a significantly lower pedestrian crash rate compared to an unmarked crosswalk,” and at some locations, especially those with volumes greater than 12,000 vehicles per day, having a marked crosswalk was associated with a higher pedestrian crash experience compared to an unmarked crossing. Table 10-2 below provides a summary of the study’s recommendations for where marked crosswalks should be provided at uncontrolled locations.

Table 10-2. Recommendations for installing marked crosswalks and other needed pedestrian improvements at uncontrolled locations.*

Source: *Safety Effects of Marked versus Unmarked Crosswalks at Uncontrolled Locations*⁽⁷⁾

Roadway Type (Number of travel lanes and median type)	Vehicle Average Daily Traffic (ADT) ≤ 9,000			Vehicle ADT >9,000 to 12,000			Vehicle ADT >12,000 to 15,000			Vehicle ADT > 15,000		
	Speed Limit**											
	≤ 48 km/h (≤ 30 mi/h)	56 km/h (35 mi/h)	64 km/h (40 mi/h)	≤ 48 km/h (≤ 30 mi/h)	56 km/h (35 mi/h)	64 km/h (40 mi/h)	≤ 48 km/h (≤ 30 mi/h)	56 km/h (35 mi/h)	64 km/h (40 mi/h)	≤ 48 km/h (≤ 30 mi/h)	56 km/h (35 mi/h)	64 km/h (40 mi/h)
2 Lanes	C	C	P	C	C	P	C	C	N	C	P	N
3 Lanes	C	C	P	C	P	P	P	P	N	P	N	N
Multilane (4 or more lanes) with raised median***	C	C	P	C	P	N	P	P	N	N	N	N
Multilane (4 or more lanes) without raised median	C	P	N	P	P	N	N	N	N	N	N	N

Notes:

*These guidelines include intersection and midblock locations with no traffic signals or stop signs on the approach to the crossing. They do not apply to school crossings. A two-way center turn lane is not considered a median. Crosswalks should not be installed at locations that could present an increased safety risk to pedestrians, such as where there is poor sight distance, complex or confusing designs, a substantial volume of heavy trucks, or other dangers, without first providing adequate design features and/or traffic control devices. Adding crosswalks alone will not make crossings safer, nor will they necessarily result in more vehicles stopping for pedestrians. Whether or not marked crosswalks are installed, it is important to consider other pedestrian facility enhancements (e.g., raised median, traffic signal, roadway narrowing, enhanced overhead lighting, traffic calming measures, curb extensions), as needed, to improve the safety of the crossing. These are general recommendations; good engineering judgment should be used in individual cases for deciding where to install crosswalks.

** Where the speed limit exceeds 64 km/h (40 mi/h), marked crosswalks alone should not be used at unsignalized locations.

*** The raised median or crossing island must be at least 1.2 m (4 ft) wide and 1.8 m (6 ft) long to adequately serve as a refuge area for pedestrians in accordance with MUTCD and AASHTO guidelines.

C = Candidate sites for marked crosswalks. Marked crosswalks must be installed carefully and selectively after an engineering study is performed.

P = Possible increase in pedestrian crash risk may occur if crosswalks are added without other pedestrian facility enhancements. These locations should be closely monitored and enhanced with other pedestrian crossing improvements, if necessary, before adding a marked crosswalk.

N = Marked crosswalks alone are insufficient, since pedestrian crash risk may be increased due to providing marked crosswalks alone. Consider using other treatments, such as traffic calming treatments, traffic signals with pedestrian signals where warranted, or other substantial crossing improvement to improve crossing safety for pedestrians.

10.9 ITS Technology

The information and images in the following ITS section have been taken directly from the PedSmart website maintained by PBIC with funding from the USDOT and the Centers for Disease Control and Prevention.⁽⁸⁾

In-Roadway Warning Lights

In-roadway warning lights are being used at crosswalks to alert motorists to the presence of a pedestrian crossing or preparing to cross the street (see figures 10-10 and 10-11). Since the lights only flash when activated by the pedestrian, the motorist receives real-time information indicating that a pedestrian is in the vicinity of the crosswalk. The amber lights are embedded in the pavement on both sides of the crosswalk and oriented to face oncoming traffic. When the pedestrian activates the system, either by using a pushbutton or through detection from an automated device, the lights begin to flash at a constant rate, warning the motorist that a pedestrian is in the vicinity of the crosswalk ahead.



Figure 10-10. Illustration. Example of in-roadway warning lights.

Source: PBIC, <http://www.walkinginfo.org/pedsmart/devcmain.htm>⁽⁸⁾



Figure 10-11. Photo. Working example of in-roadway warning lights with pedestrian pushbutton in Austin, Texas.

The amber light-emitting diode (LED) lights flash in unison at a rate designed for maximum motorist recognition and are visible during the daylight as well as at night. The flashing lights are only activated when a pedestrian wants to cross and are automatically shut off after a set period of time, i.e., the time required for a pedestrian to safely cross the street. If installed in conjunction with the means to detect the presence of pedestrians while in the crosswalk, the crossing interval can be extended, in which case the lights would continue to flash and allow slower pedestrians to safely cross.

A study by Huang, et al., in 1999 found that the “flashing crosswalk had small positive effects on reducing vehicle speeds, increasing vehicle yielding to pedestrians, and reducing pedestrian-motor vehicle conflicts,” but it was less effective in channelizing pedestrians.⁽⁹⁾

Countdown Signal

Countdown signals are used in conjunction with conventional pedestrian signals to provide information to the pedestrian regarding the amount of time remaining to safely cross the street (see figure 10-12). It is hypothesized that pedestrians will use this information to make better decisions about when to enter the crosswalk. Depending on user preference, the countdown timer starts either when the WALK or Walking Person indication appears or when the flashing DON'T WALK or Hand indication appears. The timer continues counting down through the flashing DON'T WALK (Hand) clearance interval. When the steady DON'T WALK or Hand appears, the countdown signal will be at zero.



Figure 10-12. Photo. Example of countdown pedestrian signal in Lauderdale-By-The-Sea, FL.

Animated Eyes Display

Animated eyes are intended for use at pedestrian crosswalks as an alternative to conventional pedestrian signals (see figure 10-13). Animated eyes displays are expected to encourage pedestrians to look for turning vehicles traveling on an intersecting path by including a prompt as part of the pedestrian signal. The prompt is a pair of animated eyes that scan from side to side at the start of the WALK indication. Depending on user preference, the animated eyes can be illuminated separately from the standard pedestrian symbol (walking person) for the beginning of the WALK phase or illuminated concurrently with the standard symbol.



Figure 10-13. Example of animated eyes display.

Source: <http://www.walkinginfo.org/pedsmart/devcmain.htm>⁽⁸⁾

The animated eyes display uses an LED pedestrian signal head and adds animated eyes that scan from side to side. The device uses narrow (8-degree) field of view blue (460 nanometers (nm)) LEDs on a black background. The display is highly visible to pedestrians while restricting signal visibility to motorists. The eyes, which appear to scan left and right at the rate of one cycle per second, are 13 cm (5 in) wide, 6.9 cm (2.7 in) high, and 5.7 cm (2.25 in) apart. The WALK portion of the display is a 28.4-cm-high (11.2-in-high) outline of a walking person (a standard pedestrian symbol) constructed from blue LEDs. The DON'T WALK display is a 28.4-cm-high (11.2-in-high) upraised hand constructed from Portland orange (6.15 nm) LEDs.

Detection Devices

Microwave Detector

The microwave pedestrian detector provides the means to automatically detect the presence of pedestrians in the targeted curbside area and/or while moving in a designated crosswalk area. In figure 10-14, pedestrians in the curbside microwave detection zone (shown in red) will activate the call feature, while slower pedestrians detected within the onstreet detection zones (shown in blue) receive more time to cross the street.

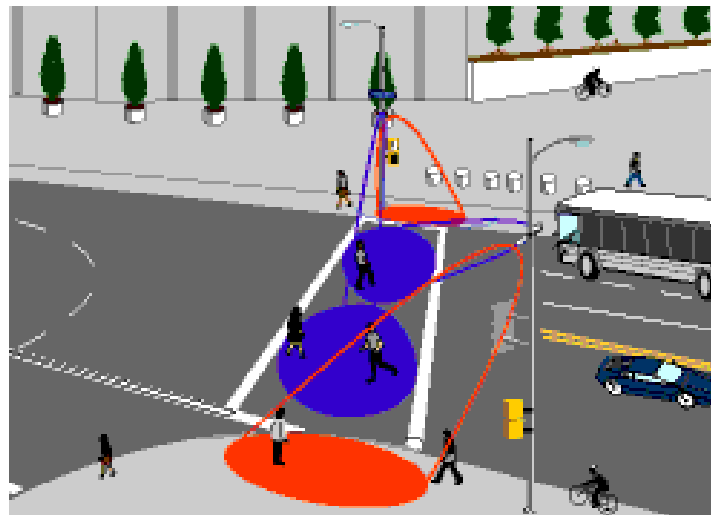

Figure 10-14. Example of a microwave detector system.

Source: <http://www.walkinginfo.org/pedsmart/devcmain.htm>⁽⁸⁾

When used at the curbside area, it may either replace or augment the standard pushbutton used to activate the pedestrian call feature. When used to detect pedestrians in the crosswalk, its function is to detect the presence of individuals requiring additional time to cross, appropriately extend the clearance interval, and provide more time to cross.

Infrared Detector

The passive infrared detector provides the capability to automatically detect the presence of pedestrians in the targeted curbside area or within the crosswalk. In figure 10-15, pedestrians entering the curbside infrared detection zone (shown in red) will activate the pedestrian call feature, while those detected in the crosswalk (shown in blue) will extend the clearance interval. When used to detect pedestrians in the crosswalk, its function is to detect the presence of individuals requiring additional time to cross, appropriately extend the clearance interval, and provide more time to cross.

Both these types of detectors function by sensing changes in thermal radiation caused by pedestrian movement within the targeted areas. These detectors may be used either to supplement or to replace the standard pushbutton used to activate the pedestrian call feature.

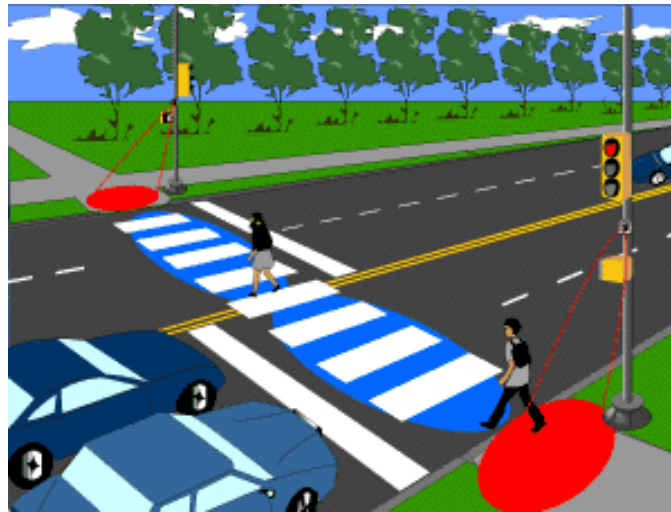

Figure 10-15. Illustration. Example of an infrared detector system.

Source: <http://www.walkinginfo.org/pedsmart/devcmain.htm>⁽⁸⁾

Illuminated Pushbuttons

The illuminated pushbutton is simple technology designed to provide immediate feedback to the pedestrian that the button is working and that the signal will change (see figure 10-16). Use of the illuminated button may reduce the number of pedestrians who cross against the signal because they have no indication that a standard pushbutton is working. Because of an immediate response from the light, the illuminated button may also result in fewer pedestrians pushing the button multiple times. This can result in longer life for the pushbutton itself.

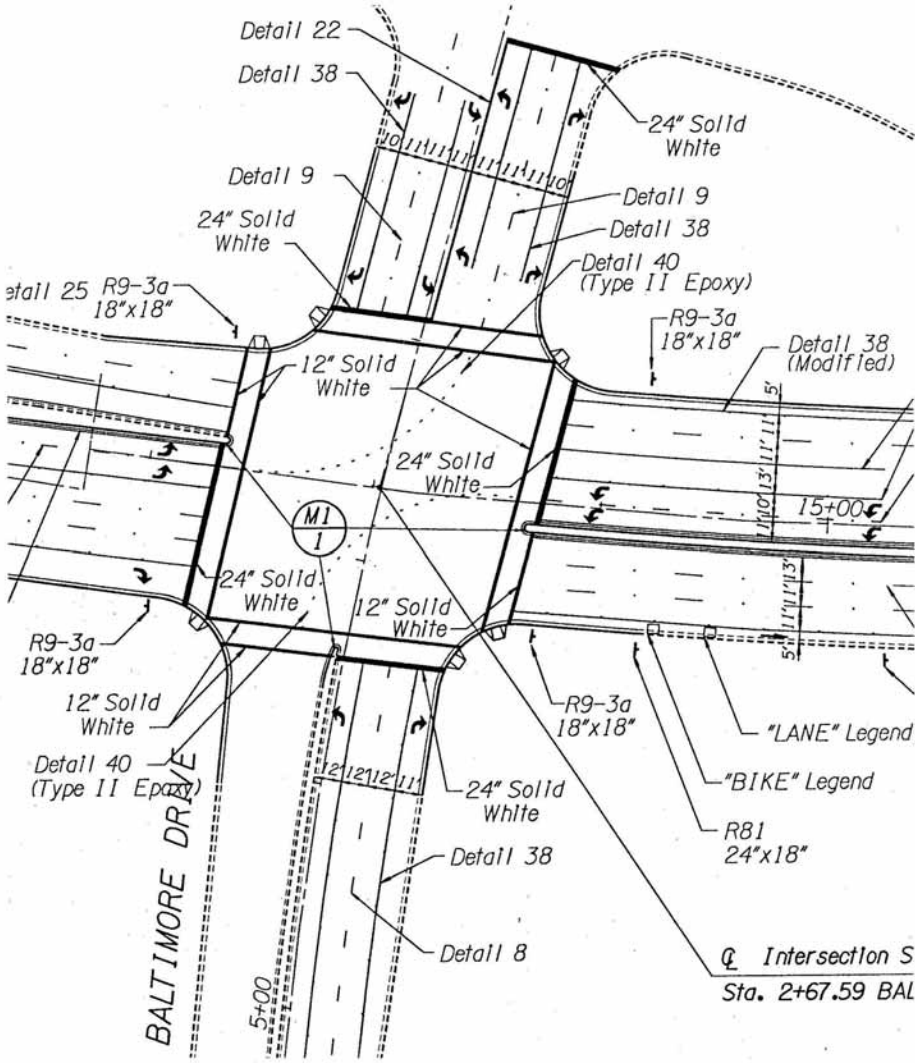

Figure 10-16. Photo. Illuminated pushbuttons.

Source: Polara Engineering, http://www.polara.com/BD_Features.htm

10.10 Student Exercise

The need to develop and detail pedestrian signs and pavement markings in a manner in which these provisions can be constructed within the normal field of highway construction is an extremely important issue. Signs and pavement markings for a proposed roadway project are specified through a detailed system of standard drawings, specifications, and bid item numbers. An example plan view drawing demonstrating this method for highway-related signs and pavement markings using California Department of Transportation (Caltrans) specifications is provided for reference in figure 10-17.



1 in = 2.54 cm

Figure 10-17. Illustration. Example signing and marking plan for SR 8 by Fletcher Parkway Construction Plans, La Mesa, CA.

Engineers use such standards to ensure uniform construction; contractors use them to develop construction cost estimates for their bids. The use of these procedures in developing designs is a critical link in the continuum of planning, designing, and constructing transportation facilities. Construction of pedestrian and bicycle facilities should make full use of this well-established system. Most State DOTs have a variety of specifications that pertain to pedestrian and bicycle facilities.

Using the summary of standard drawings for bicycle and pedestrian facility construction provided below (taken from the Caltrans Standard Plans document), develop a plan to install pedestrian signs and pavement markings that uses nomenclature and reference standards from your State DOT. Estimate the quantity of each construction item needed and develop an engineer's construction cost estimate. You will need to utilize the following resources:

- Standard drawings (periodically published document).
- Standard specifications (periodically published document).
- Bid item numbers (typically a published list).
- Statewide average bid summary (typically assembled several times a year).

10.11 References and Additional Resources

The references for this lesson are:

1. MUTCD, FHWA, McLean, VA, 2003 edition, available online at <http://mutcd.fhwa.dot.gov/HTM/2003/html-index.htm>, accessed February 25, 2004.
2. Image Library, PBIC, available online at <http://www.pedbikeimages.org>, accessed May 6, 2004.
3. Zador, P., J. Moshman, and L. Marcus, "Adoption of right turn on red: effects on crashes at signalized intersections," *Accident Analysis and Prevention*, vol. 14, no.3, Elsevier Ltd., June 1982, available online at <http://www.sciencedirect.com/science/journal/00014575>.
4. *A Policy on Geometric Design of Highways and Streets*, AASHTO, Washington DC, 2001.
5. McGee, H.W., "Accident Experience with Right-Turn-on-Red," *Transportation Research Record 644*, TRB, Washington, DC, 1976, pp. 66–75.
6. Pline, J.L., Ed., *Traffic Control Devices Handbook*, ITE, Washington, DC, 2001.
7. Zegeer, C.V., J.R. Stewart, H.H. Huang, P.A. Lagerwey, *Safety Effects of Marked versus Unmarked Crosswalks at Uncontrolled Locations: Executive Summary and Recommended Guidelines*, FHWA, FHWA-RD-01-075, McLean, VA, March 2001, available online at http://www.walkinginfo.org/pdf/r&d/crosswalk_021302.pdf, accessed February 26, 2004.
8. *ITS Technologies*, PedSmart website, FHWA, Washington, DC, 1999, available online at <http://www.walkinginfo.org/pedsmart/devcmain.htm>, accessed February 25, 2004.
9. Huang, H.H., R. Hughes, C.V. Zegeer, and M. Nitzburg, *An Evaluation of the LightGuard™ Pedestrian Crosswalk Warning System*, Florida Department of Transportation, Tallahassee, FL, June 1999, available online at http://www.dot.state.fl.us/safety/ped_bike/brochures/pdf/lgresrch.pdf, accessed May 18, 2004.

Additional resources for this lesson include:

- “Accessible Pedestrian Signals: Synthesis and Guide to Best Practice,” *National Cooperative Highway Research Program Research Results Digest*, number 278, 2003, available online at http://trb.org/news/blurb_detail.asp?ID=1705.
- *Design and Safety of Pedestrian Facilities—A Recommended Practice of ITE*, ITE, Washington, DC, 1998.
- *Florida Pedestrian Planning and Design Handbook*, Florida Department of Transportation, 1999, available online at http://www.dot.state.fl.us/safety/ped_bike/ped_bike_standards.htm#Florida%20Ped%20Handbook .
- *Implementing Pedestrian Improvements at the Local Level*, FHWA, FHWA-98-138, 1998, available online at http://safety.fhwa.dot.gov/ped_bike/docs/localpedguide.pdf.
- *Oregon Bicycle and Pedestrian Plan*, Oregon Department of Transportation, 1995.
- Van Houten, R.; R.A. Retting, C.M. Farmer, and J. Van Houten, “Field evaluation of a leading pedestrian interval signal phase at three urban intersections,” *Transportation Research Record*, TRB, Washington, DC, in press.

LESSON 11:

PEDESTRIAN DESIGN AT INTERSECTIONS

11.1 Introduction

Walkways provide mobility along a linear path. Eventually, people need to cross roads and streets at intersections. These intersections, where the paths of people and vehicles come together, can be the most challenging part of negotiating a pedestrian network. If pedestrians cannot cross the street safely, then mobility is severely limited, access is denied, and walking as a mode of travel is discouraged.

This lesson provides an overview of several design features critical to providing pedestrian access at intersections. Much research has been done on this topic, and several design manuals provide much detail, including the MUTCD, the AASHTO *Guide for the Planning, Design, and Operation of Pedestrian Facilities*, and the ITE *Design and Safety of Pedestrian Facilities*, among others.^(1,2,3) The major sections of this lesson are as follows:

- 11.1 Introduction.
- 11.2 Intersection Design Principles.
- 11.3 Crosswalks.
- 11.4 Curb Ramps.
- 11.5 Crossing and Detection Technology.
- 11.6 Pedestrian Signal Heads and Half-Signals.
- 11.7 Curb Extensions and Curb Radii.
- 11.8 Signal Timing and Pushbuttons.
- 11.9 Pedestrian Refuge Islands.
- 11.10 Roundabouts.
- 11.11 Student Exercise.
- 11.12 References and Additional Resources.

Text for this lesson was taken from the FHWA 1998 report titled *Implementing Pedestrian Improvements at the Local Level*.⁽⁴⁾ It has been reprinted with minor modifications and updates. Other information has been drawn from the ITE publication, *Design and Safety of Pedestrian Facilities—A Recommended Practice of ITE*.⁽³⁾

11.2 Intersection Design Principles

In urban areas, two-thirds of pedestrian injuries occur at central business district (CBD) intersections. A suitable example of such injuries is the intersection dash, in which a pedestrian enters the street at an intersection and is seen too late by the driver of a motor vehicle. This is the third most prevalent pedestrian crash type, accounting for 7.2 percent of all pedestrian crashes.

The solution to such pedestrian crashes at intersections is to design and build intersections that:

- Encourage pedestrian use rather than at midblock crossing locations.
- Make pedestrians as visible as possible.

- Make pedestrian actions as predictable as possible.
- Slow vehicular traffic.

A good place to start is to develop design guidelines for intersections that respond to the needs of pedestrians—guidelines that can be followed whenever new intersections are built or when existing intersections are being improved or reconstructed.

Table 11-1 contains important intersection issues and potential solutions:

Table 11-1. Intersection issues for safe pedestrian crossings.

Issue	Improvement
Improved pedestrian conspicuity	<ul style="list-style-type: none"> • Painted crosswalks in the roadway. • Extensions to move pedestrians out from behind parked cars (see figure 11-1). • Improved horizontal and vertical sight distances through the removal of extraneous curbside clutter (newspaper boxes, redundant utility poles, overgrown vegetation, etc.).
Speed reduction of motor vehicle drivers	<ul style="list-style-type: none"> • Raised intersections to alert drivers that the area is not designed for rapid through movement and pedestrians can be expected. • Right-turn slip lanes with exit angles between 50 and 60 degrees.
Predictability and control of pedestrian actions and movement	<ul style="list-style-type: none"> • Crosswalks. • Signalization.
Distance and time that pedestrians have to cross a roadway	<ul style="list-style-type: none"> • Curb extensions. • Medians. • Refuge islands.
Ease of movement from walkway to street level and vice versa	<ul style="list-style-type: none"> • Curb ramps to facilitate the transition from walkways to streets. • Raised intersections that eliminate the need for curb ramps and make the crosswalk a natural extension of the walkway.



Figure 11-1. Photo. Reduced visibility of pedestrians behind parked cars can create conflict.

Improving intersections for pedestrians involves the coordination and integration of a number of design elements, including crosswalks, curb ramps, curb extensions, turning radii, and signalization. Some other important considerations when designing intersections include:

- Taking vertical as well as horizontal sight distances into account.
- Referring to the AASHTO *Guide for the Planning, Design, and Operation of Pedestrian Facilities* for formulas relating to storage space needed for pedestrians.⁽²⁾
- Prohibiting parking near intersections.
- Limiting right-turn-on-red movements in areas of high pedestrian volumes.
- Keeping crosswalks at right angles to turning roadway terminals and slip lanes.
- Keeping right turns below 24.2 km/h (15 mi/h) and left turns below 32.2 km/h (20 mi/h).
- Locating crossing close to the parallel street [0.6 m (2 ft)] of offset is standard).
- Using stop bars for motorists and keep stop bars behind crosswalks.

11.3 Crosswalks

Typical Concerns

Of the 61 different pedestrian crash types, the midblock dart-out type—where a pedestrian may suddenly appear between parked cars or otherwise cross a vehicular way at a random location—accounts for 13.3 percent of all pedestrian crashes. In three-quarters of these cases, the crash occurs in the curbside lane. One-third of midblock dart-outs result in serious injury or fatality.

Possible Solutions

One solution is to create an ongoing retrofit program to establish crosswalks in locations that encourage pedestrians to cross in specific locations and that also provide motorists with a reasonable expectation of where pedestrians might cross a roadway. Crosswalks are one tool that municipalities can use to accomplish both goals. Other tools include curb extensions and medians (discussed later in this lesson).

Important crosswalk concepts and issues include:

1. **Creating reasonable expectations where pedestrians may cross a roadway.** A crosswalk creates a visible indication for both motorists and pedestrians as to where pedestrians may be expected to cross a roadway.
2. **Controlling pedestrian actions and movement.** When combined with signalization (as well as curb extensions and refuge islands, where appropriate), crosswalks can help to control pedestrian movement and make them more routine and predictable (see figure 11-2).



Figure 11-2. Photo. Use of colored crosswalks and median refuges makes this intersection more pedestrian-friendly.

3. **Knowing when and where crosswalks are appropriate.** As noted in the Oregon *Bicycle and Pedestrian Plan*, some studies have found that pedestrians may develop a false sense of security when crossing a road in marked crosswalks.⁽⁵⁾ Other studies have found that motorists are more likely to stop for pedestrians in marked crosswalks, especially where pedestrian right-of-way laws are enforced.

It is important that the proper use of crosswalks is backed up by State law. Vermont is one State whose law gives pedestrians conditional right-of-way when using marked crosswalks. As long as “traffic control signals are not in operation, the driver of a vehicle shall yield the right-of-way, slowing down or stopping, if necessary, to a pedestrian crossing the roadway within a crosswalk” (*Vermont Statutes, §1051(a)*).⁽⁶⁾ Where this law is reinforced by signage in the crosswalk itself, reminding drivers of the State law and their responsibility to stop, some town select board officials have said that drivers’ habits markedly favor pedestrians. The responsibility, however, is on the pedestrian to safely enter a crosswalk. Vermont law continues, “No pedestrian may suddenly leave a curb or other place of safety and walk or run into the path of a vehicle which is so close that it is impossible for a driver to yield” (*Vermont Statutes, §1051 (b)*).⁽⁶⁾

4. **Deciding where crosswalks might be located.** Generally, marked crosswalks are located at all open legs of signalized intersections. They may also be provided at other locations. When used with curb extensions, signage, and illumination, the visibility of pedestrian crossings can be enhanced.

Although expected at intersections, the installation of crosswalks at midblock locations may also be desirable under some conditions, such as when medians or refuge islands are used.

ITE recommends that certain conditions may not warrant the installation of marked crosswalks, such as when the hourly peak pedestrian volume is very low (<25 pedestrians per peak 4 hours) or when traffic volume is very low (<2,000 AADT). At all other locations, or where predominately young, elderly, or disabled pedestrians may be found, crosswalks are recommended.

Implementation Strategies

1. **Develop and adopt a crosswalk policy and design guidelines.** Decide where crosswalks shall be used; when policies and ordinances are changed or updated, make sure a crosswalk policy is implemented. Likewise, develop standard crosswalk designs for the public works department to follow.
2. **Piggyback on capital and/or maintenance projects.** Look for opportunities to install crosswalks whenever intersections are changed or upgraded or when roadways are resurfaced.
3. **Use crosswalks to connect sidewalks and curb ramps at intersections.** Coordinate crosswalk painting with new or existing curb ramp locations.
4. **Establish an annual crosswalk improvement program.** Schedule crosswalk replacement or repainting so that crosswalk markings never become deteriorated or less visible to motorists. The duty of a driver to yield right-of-way to a pedestrian in a crosswalk may be compromised if the driver could not see the crosswalk or one did not exist. Furthermore, the municipality may be liable for failing to exercise due care toward maintaining the crosswalk for pedestrians, especially if the municipality knew or should have known of a crosswalk deficiency.
5. **Implement a vigorous enforcement program.** Convince law enforcement authorities to actively monitor crosswalk behavior, enforce crosswalk laws, and prosecute crosswalk scofflaws. Create and implement a public relations program to increase public awareness about the rights and responsibilities of crosswalk use. Emphasize crosswalk laws through the use of informational signage at crosswalk locations.

Resources and Scheduling

Crosswalks are relatively inexpensive to install. Obtaining authorization to install them, on the other hand, could take months or longer.

Evaluation

An informal traffic study can determine if the crosswalk program is enhancing pedestrian safety. Especially monitor locations of high pedestrian use. Review crash statistics on a regular basis.

Planning and Design Considerations

When planning and designing crosswalks, consider these recommendations:

- Place crosswalks across the full width of the pavement.
- Use crosswalks at all signalized intersections.
- Use crosswalks at unsignalized intersections with discretion.
- Place crosswalks in locations where they are visible and where they are not obscured by parked cars or signs.
- Illuminate midblock crosswalks that are not expected by motorists.
- Use two white parallel lines 0.2 m to 0.6 m (0.5 ft to 2.0 ft) wide, spaced at a 1.8-m (6-ft) minimum, or the width of the approaching sidewalk if it is greater, to define a crosswalk area.

- Use special markings such as striped (zebra) longitudinal lines or diagonal crosshatching for added visibility and to emphasize a crossing.
- Use crosswalks at the corners of skewed intersections.
- Where warranted, the lighting levels in pedestrian areas should meet those recommended by the Illuminating Engineering Society (IES).
- Ensure that crossings have a smooth, even surface for people who use wheelchairs, walkers, or have other mobility impairments.

11.4 Curb Ramps

Curb ramps at intersections are an important design feature which should be considered. Refer to lesson 8.6, “Design Requirements,” or lesson 9.3, “Basic Sidewalk Elements,” for more information about curb ramps.

Typical Concerns

The absence of curb ramps prevents many wheelchair users from crossing streets. Such a deficiency is common in many communities. Even if ramps are provided, they may be poorly designed. Typical problems include:

- Steep slopes.
- Lack of a flat landing area.
- Obstructions in or near the ramp.
- Lip at street connection.
- Severe counter slope at gutter.
- Water, ice, or debris at the toe of ramp.
- Ramps that are too narrow to accommodate wheelchairs.
- Uneven surfaces.

When new public walkways are built, the ADA requires a curb ramp at each curbed street crossing. Ramps must also be added when roadways are repaired. A Pennsylvania court interpreted this requirement very broadly to include annual street resurfacing programs.⁽⁷⁾ ADA also requires that curb ramps be installed in new development, annual programs, and capital projects. A transition plan should show how a community will systematically install curb ramps, especially at key locations like social service agencies and transit stops.

Possible Solutions

The solution is to install curb ramps using ADA design guidelines. Curb ramps should be installed along with all new walkways. A program to retrofit existing walkways with curb ramps should be developed. Existing curb ramps should be inspected and replaced if they do not meet ADA guidelines.

Implementation Strategies

Having curb ramps installed at all intersections with sidewalks requires a clear, well-planned strategy that may require a period of several years to fully implement. Here are three keys to a successful implementation.

1. **Regulate new development and redevelopment.** Make sure all permits involving walkways include curb ramps. Because this is required by ADA, it should not be hard to implement. Local ordinances may

need changing, or where there is less formality, a simple directive might be issued. The same goes for bringing standard plans and specifications into compliance with ADA guidelines.

Simply changing the regulations to require curb ramps, however, may not be enough. People who review new plans and issue permits must know where ramps are appropriately located and what an acceptable design is. Here are a few steps to consider:

- a. Find out who reviews plans and issues permits. They may or may not be the same people.
 - b. Educate them on ADA and local curb ramp requirements (location and design). This could involve developing typical layouts and designs, a special training session, or a presentation at a staff meeting.
 - c. Follow up. Education is not a one-time effort—employees move on and new ones take their places. Periodic memos and presentations can keep everyone on track.
 - d. Inspectors are key players. Involve them in each of the steps above.
2. **Capital projects and annual programs.** ADA requires curb ramps to be installed whenever “alterations to existing transportation infrastructure” are made. In other words, all capital projects and annual programs must be scrutinized for opportunities to install new ramps to ensure that all new or rebuilt intersections conform to ADA requirements. This can include construction projects ranging from annual resurfacing programs to major signalization upgrades and street widening.

Implementing a curb ramp requirement for all capital projects and annual programs requires an ongoing, concerted effort. There are several things that can be done:

- Work with the managers of annual programs, such as asphalt resurfacing, to identify locations where curb ramps should be installed.
 - Make sure curb ramps are written into all scope of work text and budgets for funding proposals and locally funded capital projects.
 - As projects are funded and staff assigned, make sure the project manager knows where curb ramps must be included in the project. Have someone knowledgeable review designs to make sure well-designed curb ramps have been included.
3. **Annual curb ramp installation programs.** To meet ADA requirements, an annual curb ramp installation program will likely need to be created. Here are some ways to get started:
- Encourage staff and constituents to identify locations where ramps are needed. Try distributing ramp request forms in the form of public request cards (see figure 11-3) to agencies and groups involved with the disabled community.
 - Evaluate and respond quickly to returned ramp request forms.
 - Develop a systematic way for identifying priority locations. Start by looking at sites that serve transit, social service agencies, schools, and neighborhood shopping areas. Curb ramp projects may be built by either contractors or the public works department. Both ways can work, and one is not necessarily less expensive than the other. However, here are two important points to consider:
 - Curb ramps must be properly built. Even a 0.6-cm (0.25-in) lip on a ramp can make it difficult, if not impossible, for some wheelchair users to negotiate it.

- It helps public relations to respond to ramp requests within a reasonable amount of time—less than six months. When using private contractors, it may make sense to bid some of the ramps on a per unit basis as opposed to a site-specific basis to allow for quickest response to citizen requests.





 CITIZEN WHEELCHAIR RAMP REQUEST  City of Seattle Wheelchair Ramp Program		
Please provide a written description or sketch of the location(s) where wheelchair ramps would make your travel more safe and convenient.		
LOCATION: <u>NE NW SE SW All</u> corner(s) of the <small>(please circle appropriate locations)</small>		
intersection between _____ <small>(please list intersecting streets above)</small>		
PLEASE PROVIDE BELOW Comments, Suggestions or Other Information that may assist us in providing a better service to you!		Please mark intersection corners needing wheelchair ramps with an "X".
<hr/>		
REPORTED BY: Name _____ Day Phone _____		
Address _____ Zip _____ Date _____		
Please return to: Wheelchair Ramp Program Rm 708 Municipal Building Seattle, WA 98104		For more information, Contact Pam Hamlin at 684-5377

Figure 11-3. Photo. Ramp request form used by the City of Seattle, WA, Engineering Department.

Source: *Implementing Pedestrian Improvements at the Local Level*⁽⁴⁾

Resources and Scheduling

Curb ramps typically cost between \$500 and \$1,000 each. Usually, it is cheaper to install a large number at the same time or as part of other concrete work. Timely ramp installation is a key part of an overall pedestrian program. Frequently, curb ramps can be installed easily and quickly, giving communities highly visible products that can improve locations all over town. With this in mind, it is preferable to design a curb ramp program to respond to citizen requests within six months. Where narrow sidewalks and limited rights-of-way exist, installation of curb ramps may take longer. In either case, consider using a public request card like the one shown above in figure 11-3 to bring curb ramp requests to the attention of the street or public works department. The city of Seattle, WA has developed an excellent program in this regard.

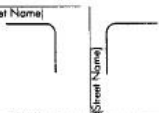
Evaluation

Check to see if ramps are being built as required and designed. In the case of new developments, do occasional checkups to see if ramps are included in new plans. The same goes for annual programs. Seek out feedback on the location and design of ramps from local organizations that include wheelchair users.

Planning and Design Considerations

Important planning and design considerations for curb ramps include:

- Maximum slope not to exceed 8.33 percent (1:12) is required.
- The width must be 0.9 m (3 ft) or greater.

- A maximum allowable cross slope is 2 percent (1:50) is required.
- Transition areas between a walkway and a ramp should be beveled 10 percent for 1.2-m (4-ft) ramps and 8.33 percent for ramps of less than 1.2 m (4 ft).
- Textured surfaces at curb ramps help identify crosswalk locations for visually impaired pedestrians (information on textured surfaces is included later in this lesson and previously in lesson 9, section 3).

Refer to lesson 8.6, “Design Requirements,” or lesson 9.3, “Basic Sidewalk Elements,” for figures and further curb ramp design information.

11.5 Crossing and Detection Technology

Typical Concerns

In some cases, simply installing a crosswalk is not enough to ensure pedestrian safety at a crossing. Therefore, several other treatments may be used in conjunction with crosswalks to improve safety and provide greater visibility of pedestrians to motorists.

Possible Solutions

Many possible solutions have already been discussed in previous chapters relating to walkways and crosswalks:

- Pavement markings and signing (lesson 10.4–10.8).
- In-roadway warning lights (lesson 10.9, “ITS Technology”).
- Automated detection devices (lesson 10.9, “ITS Technology”).
- Street lighting (lesson 9.5, “Ambience, Shade, and Other Sidewalk Enhancements”).
- Pavement surfaces and tactile ground surface indicators (lesson 9.3, “Basic Sidewalk Elements”).

As adapted from an *Informational Report* by an ITE Pedestrian and Bicycle Council Task Force Committee,⁽⁸⁾ the following list offers a few more crossing and detection technologies that could be employed at or before intersections to provide solutions for safer pedestrian crossings:

- Flags (see figure 11-4):
 - Description—Pedestrians select a flag from those posted on each side of the crosswalk, flag traffic to let drivers know they wish to cross, then return the flag to the holder on the opposite side of the street after crossing.
 - Application—Crossings on higher-volume multilane roads.
 - Cost (including labor)—\$100 including holding racks per crossing.



Figure 11-4. Photo. Flag treatment used in Kirkland, WA.

Source: ITE *Informational Report*⁽⁸⁾

- Fluorescent yellow-green signs (see figure 11-5):
 - Description—Pedestrian signs made of the FHWA-approved fluorescent yellow-green color are posted at crossings.
 - Application—Pedestrian and bicycle crossings, including schools.
 - Cost (including labor)—\$200–\$300 per sign.



Figure 11-5. Photo. Fluorescent yellow-green sign treatment in Austin, TX.

Source: ITE *Informational Report*⁽⁸⁾

- Flashing beacons (see figure 11-6):
 - Description—Flashing amber lights are installed on overhead signs, signs in advance of the crosswalk, or signs located at the entrance to the crosswalk on pedestal poles.
 - Application—Marked uncontrolled crossings.
 - Cost (including labor)—\$10,000–\$40,000 per crossing, depending on placement.



Figure 11-6. Photo. Flashing beacon treatment in Austin, TX.

Source: ITE *Informational Report*⁽⁸⁾

- Detectable warnings (see figure 11-7):
 - Description—Detectable warnings are a standardized surface feature composed of raised truncated domes, used to identify a change from pedestrian to vehicle use.
 - Application—At the base of curb ramps and curb cuts adjacent to a crossing.
 - Cost (including labor)—\$200–\$2000 per ramp or curb, depending on total area.



Figure 11-7. Photo. Detectable warnings treatment in Roseville, CA.

Source: ITE *Informational Report*⁽⁸⁾

- Staggered pedestrian crossings (Z-crossings) (see figure 11-8):
 - Description—Median islands and crosswalks laid out in a staggered configuration at uncontrolled intersections require pedestrians to walk toward traffic to reach the second half of the crosswalk.
 - Application—Across multilane roads (applications at midblock locations will be discussed in lesson 12).
 - Cost (including labor)—\$25,000–\$75,000.



Figure 11-8. Photo. Staggered pedestrian crossings (Z-crossings) treatment in San Luis Obispo, CA.

Source: ITE *Informational Report*⁽⁸⁾

11.6 Pedestrian Signal Heads and Half-Signals

Typical Concerns

Pedestrians often have trouble crossing at unsignalized intersections along arterials. This is especially true for the elderly, whose eyesight and mobility may be poor, and for children, whose judgment may be questionable. And, while most motorists may be required to stop and yield to crossing pedestrians, few arterial street drivers will stop unless forced by, for example, traffic signals.

Traffic control signals are usually placed at intersections when they meet certain warrants. In the 2003 edition of MUTCD, section 4C.05 describes the Pedestrian Volume Signal Warrant, which states that:

The need for a traffic control signal at an intersection or midblock crossing shall be considered if an engineering study finds that both of the following criteria are met:

- A. The pedestrian volume crossing the major street at an intersection or midblock location during an average day is 100 or more for each of any 4 hours or 190 or more during any 1 hour; and
- B. There are fewer than 60 gaps per hour in the traffic stream of adequate length to allow pedestrians to cross during the same period when the pedestrian volume criterion is satisfied. When there is a divided street having a median of sufficient width for pedestrians to wait, the requirement applies separately to each direction of vehicular traffic.⁽¹⁾

In general, when the Pedestrian Volume Signal Warrant is met and a new traffic control signal is installed, pedestrian signal heads are installed along with the signal. Often, jurisdictions create their own policies for when to install pedestrian signal heads. Rather than follow the MUTCD standards (or in addition to following the standards), they may rely on other design features already in place in order to determine the need for a pedestrian signal head. For instance, a community may decide to install pedestrian signal heads at all locations with intersection curb ramps. Or they may have a policy that any new traffic signal installation will automatically include pedestrian signal heads.

Where traffic volumes are high and pedestrian crossings frequent, the lack of signalized crossings makes pedestrians impatient. The result: jaywalking, unpredictable movements, and ultimately more

pedestrian-traffic crashes. Yet if the intersecting side street is lightly traveled, it makes little sense to install a full traffic signal for vehicles.

Possible Solutions

The solution is to install a pedestrian half-signal (see figure 11-9). A half-signal is a pedestrian actuated light that stops arterial traffic only, leaving the lower volume cross street unsignalized and controlled by Stop signs only. This allows pedestrians to cross safely upon demand without unnecessarily creating delays upon arterial street traffic that a fully signalized intersection might impose.



Figure 11-9. Photo. Half-signal in Portland, OR.

While a full signal might be an option, costs could easily be prohibitive. A fully signalized intersection can cost twice as much as a half-signal. If a signal on the residential street is unnecessary, the pedestrian half-signal can be an answer.

Another way to accommodate pedestrians without unnecessarily impeding arterial traffic is to tie in a half-signal with full signals on either side. In this scenario, after a pedestrian pushes the call button, the WALK signal is displayed when it is tied in with the progression of adjacent signals. This method may be more attractive to transportation engineers who don't want to impede traffic.

Section 7 of the ITE *Informational Report* summarizes the use of different signals installed for pedestrian crossings.⁽⁸⁾ Pedestrian signals can be applied to intersections where the pedestrian crossing is signalized but the intersection side street approaches are controlled by Stop signs. However, most applications of pedestrian signals in the United States are at midblock locations. These will be discussed in lesson 12.

Implementation Strategies

Here are a few ways for implementing pedestrian half-signals into an overall pedestrian program:

1. **Create an annual program.** If the need is great and local budgets can afford it, creating an annual half-signal installation program is best. This approach helps staff learn to evaluate potential locations. It also helps institutionalize the logic behind the pedestrian half-signal.

Identifying and prioritizing suitable locations is the key. Costs, however, can be high and may average from \$50,000 to \$100,000 per installation.

2. **Select suitable locations.** Half-signal sites are often suggested by local schools, hospitals, social service offices, and senior citizen centers. These institutions typically generate a lot of pedestrian trips. If one is located across from a bus stop, for example, numerous daily crossings can be expected.

Relatively low volume but difficult crossings used by children and the elderly may warrant half-signals. In such cases, common sense tempered by engineering judgment can substitute for numeric standards. Junctions of heavily used bicycle/pedestrian trails and high-volume arterials are also good candidates. Citizens, particularly the elderly, can help identify difficult intersections. Follow up their requests and complaints with onsite staff evaluations. If an intersection looks promising, conduct a detailed analysis. List the best candidate locations and prioritize based on crash histories, traffic speeds, pedestrian volumes, and characteristics.

3. **Focus on environment mitigation.** Your jurisdiction might require half-signals as a condition of development. If a given development is likely to create a pedestrian crossing problem, requiring mitigation makes sense. This approach demands clear warrants for when pedestrian half-signals are necessary to justify assessing developers the cost of traffic impacts. Issuing permits can thus be linked to half-signal installation.

Resources and Scheduling

Pedestrian half-signals cost anywhere from one quarter to one half of a full intersection signalization, depending upon the intersection. Because they are costly, it may not be feasible to install more than a few each year.

Evaluation

In many respects, it is easy to evaluate the success of a pedestrian half-signal. If the number of crashes and/or pedestrian complaints goes down, then it's a success. If the arterial has high volumes, study traffic impacts such as the frequency of motorist delays. If frequent red phases cause delays, consider lengthening the green phase a bit. To strike the right balance, observe the intersection throughout the day and, if necessary, vary the timing.

Planning and Design Considerations

Regardless of which implementation strategy is chosen, the objective conditions which warrant the use of a half-signal will have to be determined. In all likelihood, the public works department has warrants that must be met before installing a traffic signal. Most jurisdictions use MUTCD to determine signal warrants, whether the signals are to be installed for vehicular traffic or pedestrians. (It should be noted that pedestrian half-signals have not yet been incorporated in MUTCD). When should the pedestrian half-signal option be chosen over the full signalization option? Here are two useful guidelines:

- When traffic volumes on the intersecting street are less than 50 percent of MUTCD-recommended benchmarks.
- When a substantial amount of traffic might be expected to opt for and use lower-volume parallel streets in order to avoid a full signal placed along the arterial.

Because signals and their impacts are often controversial and politically sensitive, creating a flexible warrant may be appropriate, especially given the lack of MUTCD guidelines.

11.7 Curb Extensions and Curb Radii

Typical Concerns

Walking across a wide street takes longer than crossing a narrow street. As a result, pedestrians are exposed for a longer period of time to the threat of being hit by a vehicle when they cross a wide street. Another problem pedestrians face when trying to cross a street is visibility. Parked cars may make it difficult for them to see oncoming vehicles and vice versa. Also, when streets intersect at an acute or obtuse angle, or have a large curb radius, motorists can make turns at relatively high speeds. By contrast, 90-degree intersections and corners with tight curb radii tend to slow motorists down. The problem with obtuse angles is particularly bad when a vehicle on an arterial street turns onto a residential street. Pedestrians crossing the residential street adjacent to the arterial may not expect high-speed turning traffic or they may have their backs turned toward the turning cars.

Possible Solutions

The solution is to shorten the crossing distance for pedestrians. One way to effectively shorten the pedestrian crossing distance on streets where parking is permitted is to install curb extensions, also known as bulb-outs, chokers, neck-downs, or flares. Curb extensions project into the street, usually for a distance equal to the depth of a typical parallel parking space, making it easier for pedestrians to see approaching traffic and giving motorists a better view of pedestrians (see figure 11-10). When motorists are better able to see pedestrians, they have a greater opportunity to stop before a crash can occur.

Decreasing crossing distances for pedestrians also provides these motor vehicle capacity benefits:

- At signalized intersections, it decreases the length of the pedestrian phase, thereby increasing the main street green time and thus more vehicle throughput and less driver delay.
- At unsignalized intersections, it reduces the time a right- or left-turning vehicle has to wait for a pedestrian to cross before exiting the roadway.

When designing curb extensions at intersections where there is low truck traffic, consider making the corner radius as small as possible. This will have the effect of slowing down right-turning motor vehicles. Where truck traffic is present, a tight corner radius may make the turn difficult to negotiate for these vehicles. Furthermore, the constant overriding of the curb and sidewalk by rear wheels of trucks may ultimately cause damage to the curb or sidewalk or cause injury to pedestrians.



Figure 11-10. Photos. Curb extensions reduce crossing distances for pedestrians and provide additional corner storage space.

Simultaneously installing curb extensions and changing curb radii is frequently possible since both involve moving the curb and gutter into the improved portion of the street right-of-way. Adding bollards to make the corner more visible may be an alternative solution.

Where acute or obtuse intersections are encountered, such as where a residential street meets an arterial, creating an intersection that is closer to 90 degrees may also provide opportunities to reduce curb radii and create curb extensions (see figure 11-11).

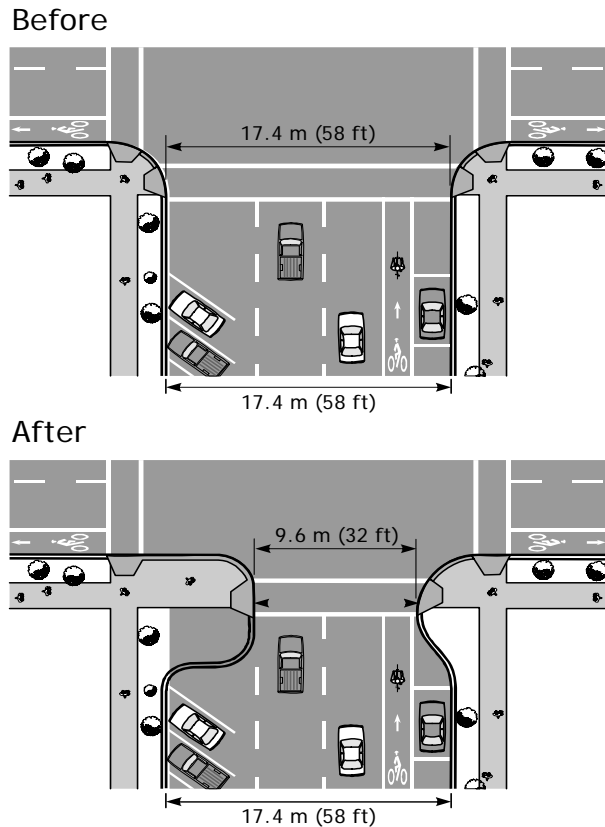

Figure 11-11. Illustration. Curb extensions improve the visibility of pedestrians by motorists and vice versa.

Implementation Strategies

Typically, curb extensions and curb radius changes are appropriate at a limited number of intersections. Consequently, over time, most intersections that need improvements may be upgraded for pedestrians in this fashion. As with other pedestrian improvements, the key is to develop a strategy and stick to it over a period of years. Here's how to get started:

1. **Determine arterial and residential street specifications.** Include curb extensions and/or smaller curb radii in standard plans and specifications for public and private road projects. A change in one or more local ordinances may be required or specifications may sometimes be implemented by administrative rule.
2. **Start an annual program to install curb extensions and adjust the curbs at obtuse-angle intersections.** Develop project selection criteria to select the projects that will do the most to enhance safety. Some areas to be considered include:
 - Locations where residential streets meet arterial streets at an obtuse angle.
 - Locations that are on routes used by schoolchildren or the elderly.
 - Downtown or neighborhood shopping areas with high pedestrian volumes.
 - Projects nominated by neighborhood associations.

Resources and Scheduling

The cost of installing curb extensions and changing curb radii can vary considerably, depending on whether drain grates have to be moved and/or whether other issues must be addressed. For example, it may be necessary to move the conduit for a signal or relocate utility poles and light and/or sign standards.

Decide if the work is to be done by the public works department or a private contractor. In general, if only a few curb extensions are involved, it may be less expensive and faster to have town or city crews do the work. If there is a lot of work to be done, it may be less expensive to use a private contractor. The key is to let the public know how long it will take to install a curb extension and then deliver promptly.

Evaluation

Visit project sites to determine if good locations have been selected and the best design(s) is being used. Check crash records, do speed studies of cars making turns, look at the curbs to see if trucks or buses are driving over them, and ask pedestrians if they feel safer. Be a good listener and observer, and make modifications where needed.

Planning and Design Considerations

Transportation agencies have increased curb radii over the years to keep trucks and buses from running over curbs and striking pedestrians standing on the corner; such changes also increase capacity. Unfortunately, curb radii have been increased at intersections that do not have large truck traffic or buses (e.g., in residential neighborhoods). The following are guidelines for curb extensions and small curb radii:

- On arterial streets, install curb extensions only where permanent parallel parking is next to the curb. Curb extensions should protrude a minimum of 1.8 m (6 ft) into the roadway. Ideally, they should project the full depth of adjacent parking stalls, usually 2.4 to 2.7 m (8 to 9 ft). Curb extension projections prevent the parking area next to the curb from becoming a travel lane.

- A curb radius of 3.0 to 4.6 m (10 to 15 ft) should be used where residential streets intersect other residential streets and arterial streets.
- A curb radius of 6.1 m (20 ft) should be used at the intersections of arterial streets that are not bus or truck routes.
- A curb radius of 7.6 to 9.1 m (25 to 30 ft) should be used at the intersections of arterial streets that are bus and/or truck routes.
- Curb extensions should not extend so far into the street that they present a bottleneck for bicycle travel. As a minimum, a 4.3-m (14-ft) travel lane should be maintained.

11.8 Signal Timing and Pushbuttons

Typical Concerns

The public is often baffled by pedestrian signal timing and pushbuttons; such pedestrian features seem to vary not only from jurisdiction to jurisdiction, but also from intersection to intersection. WALK/DON'T WALK timing lengths often appear arbitrary—especially the WALK and flashing DON'T WALK phases. Part of the problem stems from the fact that many walkers do not know that the flashing DON'T WALK is intentionally displayed before an average person can completely cross the street. Another part of the problem may result from timing cycles that are simply too fast for slow walkers such as older pedestrians or persons with disabilities.

Another aspect of the problem may be due to the absence of pedestrian pushbuttons or because a call button is obscured or difficult to reach (see figure 11-12). At many intersections that do have pushbuttons, the DON'T WALK phase is so long that pedestrians feel their pushbutton request has not been recognized by the signal system. All of these problems encourage disrespect for pedestrian signals, promote increased jaywalking, and create conflicts with motorists.



Figure 11-12. Photo. Example of obscure pedestrian pushbuttons; pushbuttons should be conveniently placed and clear from obstacles.

Possible Solutions

Develop policies governing pedestrian signal timing and pushbutton actuation to ensure fair treatment for pedestrians. Make signal timing as consistent as possible, and adopt a clear pedestrian pushbutton warrant. Develop a desired LOS for pedestrian waiting and pushbutton response times and evaluate signalized intersections to see if the pedestrian LOS at signalized intersection falls within an acceptable range.

Major issues related to pedestrians and signalized intersections include:

- Seemingly arbitrary length of WALK and flashing DON'T WALK cycles.
- Pros and cons of lengthening flashing DON'T WALK to accommodate slower pedestrians.
- Safety tradeoff of shortened pedestrian phase implemented to enhance vehicular right turns.
- Fairness of laws that allow motorists to enter an intersection on the yellow while prohibiting pedestrians from doing so during flashing DON'T WALK.
- Tradeoff between motor traffic delays and pedestrian delays at actuated pedestrian crossings.
- Integration of pedestrian recall and pedestrian actuation in way pedestrians will understand.

Implementation Strategies

Making signalized intersections consistent with stated policies won't happen overnight; consider it as part of a long-term commitment to pedestrian safety. Whatever strategy is employed, use field observations to see how pedestrians react to signal timing and pushbuttons. Comparing a variety of configurations will help. It is possible for workable and consistent policies to be developed.

1. **Annual program.** A comprehensive program should be established to evaluate and prioritize improvements. It should not be hard to locate those areas needing attention. In all likelihood, the public works department probably maintains a file filled with complaints from citizens.
2. **New signal or signal timing projects.** Review the pedestrian signal timing plan for any intersections undergoing signal modification or adjustments. Keep aware of signal work, providing appropriate suggestions. This will help signal engineers become more sensitive to pedestrian needs.

Resources and Scheduling

The peculiarities of many intersections mean that a strictly policy-driven approach may not be possible. As a result, trained personnel will be needed to evaluate signal timing and actuation at many specific locations. Most of the work will be done by agency crews unless there is a large enough backlog to justify going out to bid.

Evaluation

Monitor intersections with modified signal timing and pushbuttons, and compare them with unaltered intersections. Crash reductions and/or fewer pedestrian complaints will be good indicators of whether the new policies are working. Develop an LOS for pedestrian pushbuttons and apply accordingly.

Planning and Design Considerations

Consider these features when providing signals that are responsive to pedestrians:

- Signals must fulfill a need, gain attention, convey a clear and simple meaning, and command the respect of road users, as well as provide adequate time for response (see figure 11-13).



Figure 11-13. Illustration. Pedestrian crossing signals should be clear and understandable by all users.

- Average walking speed has been calculated at 1.2 m/s (4 ft/s); 1.1 m/s (3.5 ft/s) is becoming more common; 0.9 m/s (3 ft/s) should be used where there is a high frequency of older pedestrians; and people with mobility impairments move as slow as 0.8 m/s (2.5 ft/s). Some signal devices can provide additional time, if required, often by depressing the pushbutton for a specified period of time.
- Many pedestrians stop watching for lights and instead look for gaps to cross streets when their delay exceeds 30 seconds.
- Consider using leading pedestrian interval (LPI) to give pedestrians an advance walk signal before the motorists get a green light, thus giving the pedestrian several seconds to start into the crosswalk where there is a concurrent signal.
- Place pedestrian signal heads at each end of the crosswalk.
- Place the pushbutton at the top of and as near as possible to the curb ramp and clearly in line with the direction of travel. This will improve operations since many pedestrians push all buttons to ensure that they hit the correct one (see figure 11-14). Pedestrian pushbuttons are often provided at locations with intermittent pedestrian volumes to call for the walk message and/or extend the crossing interval.



Figure 11-14. Photo. Example of pedestrian pushbutton location.

- Use a pushbutton box that gives pedestrians a visible acknowledgment (indicator light comes on at pushbutton box) that their crossing request has been received. Where medians exist, place additional pushbuttons in medians. If signal head on opposite side of the street is more than 18.3 m (60 ft) away, place additional pedestrian signal heads in medians.
- Place pedestrian signals in channelized islands.
- Visually impaired people need audio support at key signalized intersections.
- Audio signals are available that use different sounds—from pleasant (cuckoo or tinkling bell sounds preferred) to obnoxious (avoid raspy sounding buzzers).
- Potentially use a leading pedestrian interval that allows pedestrians a head start at getting into the crosswalk and makes them more visible to motorists.
- For the WALK phase, allow time for pedestrians to look around and start walking. For coordinated signal systems, extend to full green time minus flashing.
- For the DON'T WALK phase (pedestrian clearance interval), avoid shortening the WALK phase to improve the flow of right-turning vehicles.
- The flashing DON'T WALK phase (pedestrian clearance interval) should be included in the full green time. This is calculated as part of the crossing time. Crossing time equals distance divided by 0.8 to 1.2 m/s (2.5 to 4.0 ft/s), depending on the customer base.
- For the steady DON'T WALK phase, allow equal time for the yellow clearance and the all-red signal. Pedestrians should be out of the street.

MUTCD has many suggestions regarding pushbutton placement and pedestrian signal timing. In many other areas of pedestrian activity, however, it leaves a great deal to engineering judgment.

11.9 Pedestrian Refuge Islands

Pedestrian refuge islands are defined as the areas within an intersection or between lanes of traffic where pedestrians may safely wait until vehicular traffic clears, allowing them to cross a street. Refuge islands are commonly found along wide, multilane streets where adequate pedestrian crossing time could not be provided without adversely affecting the traffic flow. These islands provide a resting area for pedestrians, particularly those who use wheelchairs, elderly, or otherwise unable to completely cross an intersection within the provided signal time. These refuge islands also provide a safety area for pedestrians caught in the street when a signal changes.

When evaluating whether a refuge island is needed, both crossing time and safety must be considered. For example, in suburban areas with long distances between intersections and traffic signals, a large proportion of pedestrian crossings occur at unsignalized intersections and at midblock locations. However, with a median, a pedestrian would only have to look in one direction to cross to the median, and in the opposite direction to complete their crossing from the median to the far side of the street. Pedestrians crossing an undivided, multilane street may experience delays 10 times longer than the delay incurred crossing a street with a median as shown by the pedestrian crossing delay curves provided in the National Cooperative Highway Research Program (NCHRP) Report 294A.⁽⁹⁾

The effect of refuge islands and medians (see figure 11-15) on pedestrian safety is unclear. Studies have reported both increases and decreases in crashes after pedestrian islands have been installed. There is a substantial lack of definitive information on this subject. However, a 1978 study in Western Australia indicated that the rate of pedestrian crashes at a four-lane unsignalized intersection was reduced to 11.5 percent of its original level when raised median islands were installed.⁽¹⁰⁾



Figure 11-15. Photo. Streets with raised medians usually have lower pedestrian crash rates.

Refuge islands can be beneficial under certain conditions and inconsequential or even harmful under others. The typical conditions where refuge islands are most beneficial include:

- Wide, two-way streets (four lanes or more) with high traffic volumes, high travel speeds, and large pedestrian volumes.
- Wide streets where the elderly, people with disabilities, and children cross regularly.
- Streets with insufficient green signal phasing time for safe pedestrian crossings.
- Wide, two-way intersections with high traffic volumes and significant numbers of crossing pedestrians.
- Low-volume side-street traffic demands with insufficient green time to cross—low side-street volumes in combination with high main street volumes may warrant short green times for the side street, which, in turn, does not allow enough time for the pedestrian to cross the entire street.

The typical conditions where refuge islands are least beneficial or possibly harmful include:

- Narrow streets and/or streets where substandard-width refuge islands are used.
- Instances in which a high turning volume of large trucks exist.
- Where space is needed more for sidewalks.
- Conditions under which the roadway alignment obscures the island, thereby making it likely that vehicles will drive onto the island.
- Areas where the presence of a safety island will severely hamper snowplowing.

In areas where refuge islands are beneficial, the advantages to pedestrians are many, including:

- Reducing pedestrian crossing time by splitting crossing distances (i.e., providing staged crossing of pedestrians), thereby reducing the green time required for the pedestrian crossing phase.
- Providing pedestrians with a resting place when crossing wide roads or intersections (see figure 11-16).
- Providing a pedestrian storage area.
- Increasing the capacity of the intersection with a near-side island that provides a better location for the stop bar.
- Loading and unloading transit riders (although curbside locations provide a better alternative).
- Providing a location for traffic control (shorter mast arms) and utility pole installations.



Figure 11-16. Photo. Refuge islands provide pedestrians with a resting place when crossing roads or intersections.

The disadvantages of pedestrian refuge islands include:

- A false sense of security or safety to pedestrians.
- Street sweeping or snowplowing problems.
- Damage to vehicles if struck.
- High installation costs.
- Generally greater right-of-way requirements.

Recommended Practice

Pedestrian refuge islands may be installed at intersections or midblock locations as deemed appropriate by engineering studies. Refuge islands should be considered during the design of complex intersections or streets rather than after construction has been completed. They must be visible to motorists at all times and should be delineated by curbs, guideposts, signs, or other treatments. Refuge islands should be designed to minimize the potential hazard to motorists and pedestrians alike.

Island Design Features

Pedestrian refuge islands should be designed in accordance with AASHTO policy and MUTCD requirements. Design considerations include:

- Areas at traffic signals where the total length of crosswalk cannot be readily traveled in one pedestrian phase. Special consideration should be given to intersections where a large number of elderly pedestrians and/or people with disabilities will be present. Special consideration should also be given to complex or irregularly shaped intersections where islands could provide a pedestrian with the opportunity to rest and become oriented to the flow of oncoming traffic.
- Raised curbs with cut-through ramps at pavement level or curb ramps for wheelchair users. Cut-through ramps should be graded to drain quickly and should also have detectable warning

(truncated domes, colored pavement, etc.) to identify the refuge island. Islands with ramps should have a level area at least 1.8 m (6 ft) long at the same level as the top of the raised median to provide a level area for wheelchair users.

- Areas at least 1.8 m (6 ft) wide from the face of the curb to the face of the curb. The minimum width should not be less than 1.2 m (4 ft) wide from the face of the curb to the face of the curb. The island should not be less than 3.6 m (12 ft) long or the width of the crosswalk, whichever is greater. The minimum island size should be 4.6 m² (50 ft²).
- An approach nose, offset from the edge of the traffic lane, appropriately treated to provide motorists with sufficient warning of the island's presence. This can be achieved in various ways such as illumination, reflectorization, marking, signage, and/or size.
- Pedestrian pushbuttons and signage adjacent to crosswalks, one for each crossing, with a minimum separation of 3 m (10 ft).
- Detectable warnings for the visually impaired.
- Placement on wide (four lanes or more) streets with high traffic volumes.
- No obstruction to visibility by such features as foliage, barriers, or benches.
- Barriers that may be necessary to keep pedestrians from stepping into traffic at improper locations.

11.10 Roundabouts

According to the *Pedestrian Facilities Users Guide*:⁽¹¹⁾

A modern roundabout is built with a large, often circular, raised island located at the intersection of an arterial street with one or more crossing roadways and may take the place of a traffic signal. Traffic maneuvers around the circle in a counterclockwise direction, and then turns onto the desired street. All traffic yields to motorists in the roundabout and left-turn movements are eliminated. Unlike a typical intersection, vehicles generally flow and merge through the roundabout from each approaching street without having to stop.

Roundabouts need to accommodate pedestrians and bicyclists. It is important that automobile traffic yields to pedestrians crossing the roundabout. Splitter islands at the approaches slow vehicles and allow pedestrians to cross one traffic lane at a time. Single-lane approaches can be designed to keep speeds down to safer levels and allow pedestrians to cross. Multilane approaches have higher speeds, create multiple threats for pedestrians, and are not recommended.

Typical Concerns

Roundabouts represent a tradeoff for pedestrians (see table 11-2). Roundabouts generally improve safety for pedestrians, bicyclists, and motorists.⁽¹²⁾ A well-designed roundabout can improve pedestrian safety by:

- **Lowering vehicular speeds.** This allows more time for drivers to react to potential conflicts and reduces the pedestrian's risk of death if hit by a motor vehicle.

- **Reducing conflict points.** This eliminates the potential for hazardous conflicts, in contrast to an intersection (see figures 11-17 and 11-18). Conflicting vehicles come from a more defined path at roundabouts, and thus pedestrians have fewer places to check for conflicting vehicles.

Compared to two-way stop-controlled intersections, roundabouts may make it easier and safer for most pedestrians to cross the major street.⁽¹³⁾ At both roundabouts and two-way stop-controlled intersections, pedestrians have to judge gaps in the major (uncontrolled) stream of traffic. By reducing stopping distance, the low vehicular speeds through a roundabout generally reduce the frequency and severity of incidents involving pedestrians. In addition, when crossing an exit lane on the minor road, one's sight angle is smaller than when watching for left-turning vehicles at a conventional intersection.⁽¹³⁾

Table 11-2. Roundabout trade-off issues for pedestrians.

Benefits	Problems
Shorter crossing distances —There are generally fewer lanes to cross in a roundabout, and many crossings are broken by pedestrian refuge islands.	Out-of-direction travel —Roundabouts may be inconvenient for pedestrians because the crosswalks are set back farther from the intersection and the distance pedestrians have to travel is longer.
Decreased waiting time —Pedestrians do not need to wait for a long traffic signal cycle before they can cross the roadway.	Visually impaired pedestrians —Visually impaired pedestrians who use audible cues from the traffic movements in order to judge when it is safe to cross find fewer cues to negotiate a roundabout.

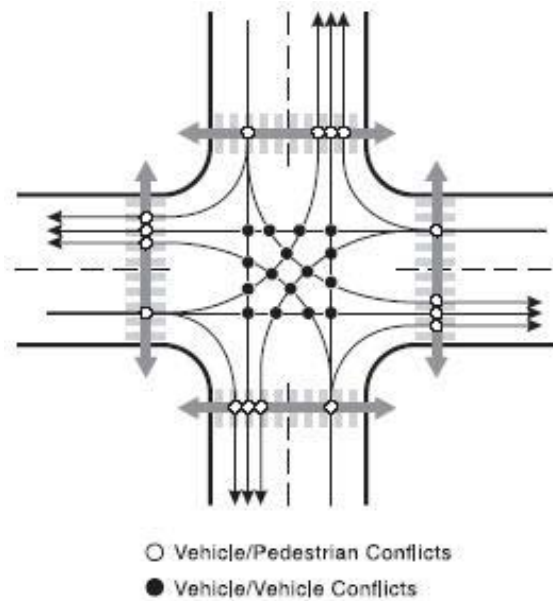

Figure 11-17. Illustration. Intersections have 16 vehicle/pedestrian conflict points.

Source: *Roundabouts: An Informational Guide*⁽¹³⁾

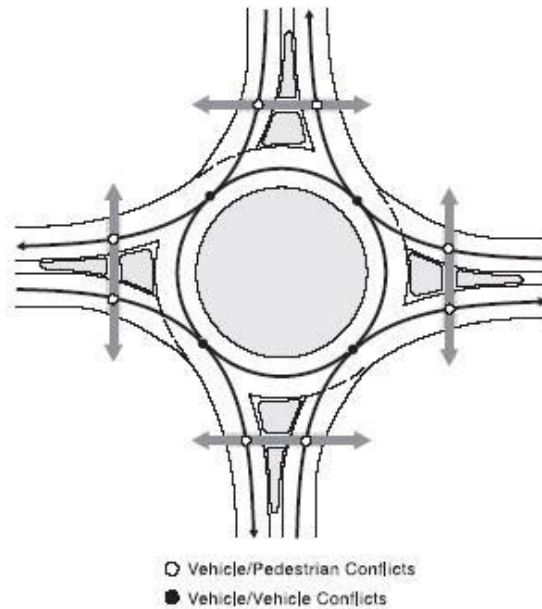

Figure 11-18. Illustration. Roundabouts have eight vehicle/pedestrian conflict points.

Source: *Roundabouts: An Informational Guide*⁽¹³⁾

Visually Impaired Pedestrians

The *Informational Guide* states that:

All-way stop-controlled intersections may be preferred by pedestrians with visual impairment because vehicles are required to stop before they enter the intersection. However, crossing the exit leg of an all-way stop-controlled intersection can be intimidating for a pedestrian since traffic may be turning onto the exit from multiple directions. Roundabouts, on the other hand, allow pedestrians to cross one direction of traffic at a time; however, traffic may be moving (even if at a slow speed), thus making it more challenging to judge gaps, especially for visually impaired users, children, and the elderly.

Elderly pedestrians, children, and pedestrians who have vision loss find it more difficult to cross unprotected road crossings. These pedestrians generally prefer larger gaps in the traffic stream, and walk at slower speeds or start later than other pedestrians. Multilane roadways entering and exiting double-lane roundabouts require additional cues to cross, since pedestrians need assurance that they have been seen by drivers in each lane they are crossing.

When crossing a roundabout, there are several areas of difficulty for the blind and/or visually impaired pedestrian. It is expected that a visually impaired pedestrian with good travel skills must be able to arrive at an unfamiliar intersection and cross it with pre-existing skills and without special, intersection-specific training. Roundabouts pose problems at several points of the crossing experience, from the perspective of information access.

Unless these issues are addressed by a design, the intersection is “inaccessible” and may not be permissible under the ADA. Chapters 5, 6, and 7 [of the *Informational Guide*] provide specific suggestions to assist in providing the above information. However, more research is required to develop the information jurisdictions need to determine where roundabouts may be appropriate and what design features may be appropriate for the disabled, such as audible signalized crossings. Until specific standards are adopted, engineers and jurisdictions must rely on existing related research and professional judgment to design pedestrian features so that they are usable by pedestrians with disabilities.⁽¹³⁾

Vision impaired pedestrians may have difficulty navigating and identifying appropriate gaps at roundabout crossings because circulating traffic masks the sounds needed to identify a gap in the traffic to make a safe crossing.

Crosswalks

Crosswalks at roundabouts can be a tricky design issue. Unlike an intersection, by vehicle code definitions there cannot be a legal unmarked crosswalk at a roundabout. A legal crosswalk at a roundabout must be marked.⁽¹¹⁾ However, many State guidelines recommend *not* painting pedestrian crossing lines across the entrances and exits of roundabouts because they could give pedestrians a false sense of security when crossing the roadway. Instead, they recommend encouraging pedestrians to identify gaps in traffic and cross when acceptable gaps are available.

According to the report, *Modern Roundabouts for Oregon*:

Priority crossing should be considered only where:

- Pedestrian volumes are high.
- There is a high proportion of young, elderly, or infirm citizens wanting to cross the road.
- Pedestrians are experiencing particular difficulty in crossing and being delayed excessively.

Most guidelines recommend the location of a crosswalk at 1 to 2 car lengths from the yield line [or] 6.1 to 10 m (20 to 33 ft). This will reduce decisionmaking problems for drivers and avoid [a] backup queue of vehicles waiting to exit roundabouts.

The ideal solution would be to have all pedestrians follow the path created for them and to have all motorists yield to them. But in moving pedestrians too far from the roundabout, pedestrians will not tolerate the out-of-direction travel created. If the crosswalks are too close to the yield line, motorists will stop on it. Therefore, the best solution is to place the crosswalk behind a stopped car, about 4.0 to 5.0 m (13 to 16.5 ft) from the entry point. This is not an ideal solution, as one cannot force pedestrians to make even this slight a detour, and when a bus or truck is stopped, it will cover the crosswalk.

This position does have the advantage of allowing a pedestrian to cross behind a stopped car waiting to enter. The driver who stops to let a pedestrian cross at an exit lane does so outside of the roundabout, in an area perceived as more comfortable than in the circulating roadway.⁽¹²⁾

The *Informational Guide* provides the following recommendations for pedestrian crosswalks at roundabouts:

- Pedestrian crossings are set back from the yield line by one or more vehicle lengths to:
 - Shorten the crossing distance compared to locations adjacent to the inscribed circle.
 - Separate vehicle-vehicle and vehicle-pedestrian conflict points.
 - Allow the second entering driver to devote full attention to crossing pedestrians while waiting for the driver ahead to enter the circulatory roadway.
- If sidewalks on the intersecting roads are adjacent to the curbs, this setback may require the sidewalks to deviate from a straight path. This is not the case if sidewalks are separated from the curbs by a generous landscape buffer.⁽¹¹⁾

Possible Solutions

Splitter Islands

Typically, modern roundabout design includes splitter islands (also called median islands) on each approach to the roundabout that serve as pedestrian refuges. By having space to pause on the splitter island, pedestrians can consider one direction of conflicting traffic at a time, which simplifies the task of crossing the street.⁽¹³⁾

There should be a cut-through in the splitter island with a minimum width of 2.0 m (6.6 ft).⁽¹²⁾ If this can't be accomplished, a raised island as narrow as 0.8 m (2.5 ft) is still preferred over a painted line alone.

Planning and Design Considerations

Some other design considerations for roundabouts include:

- Determine that street widths and/or available right-of-way are sufficient at the location to accommodate a properly designed roundabout.
- Reduce vehicle approach speed (to 24.1 to 29.0 km/h (15 to 18 mi/h)) by providing adequate deflection on each approach.
- Design splitter islands as large as the site allows.
- Prohibit parking on the approaches of the roundabouts to provide clear visibility.
- Provide street lighting to illuminate not only the circulating roadway but also the approaches.
- Locate signs and plants so as not to obscure pedestrians.
- Understand that roundabouts are generally not appropriate for multilane road intersections.
- Plan roundabouts for locations with high percentages of left-turning traffic.
- Discourage pedestrians from crossing to the central island by using landscape buffers, etc., on the corners.^(11,12,13)

Additional research is needed to determine the best way for visually impaired pedestrians to safely cross roundabouts. To this end, NCHRP has funded a significant research effort (Project 3-78) to develop crossing solutions at roundabouts and channelized turn lanes for pedestrians with vision disabilities. NCHRP Project 3-78 was scheduled to begin in late 2004.

11.11 Student Exercise

1. Look at research on roundabouts and the visually impaired and develop geometric designs or other approaches that will make roundabouts more user friendly for pedestrians who are visually impaired and don't employ visual cues to identify gaps in the traffic stream.
2. The need to develop and detail pedestrian intersection improvements in a manner that can be constructed within the normal field of highway construction is an extremely important issue. Pedestrian accommodations at intersections include both traffic signal and pavement marking improvements. An exercise covering pavement marking issues was previously addressed in exercise 10.10. With regard to signalization at intersections, pedestrian improvements typically include pedestrian signals, pedestrian pushbuttons, conduit/wiring, mounting brackets, and pedestrian poles. Traffic signal improvements are specified through a detailed system of standard drawings, specifications, and bid item numbers. An example plan view drawing demonstrating this method for specifying traffic signal improvements using Georgia Department of Transportation (GDOT) standards is provided for reference in figure 11-19.

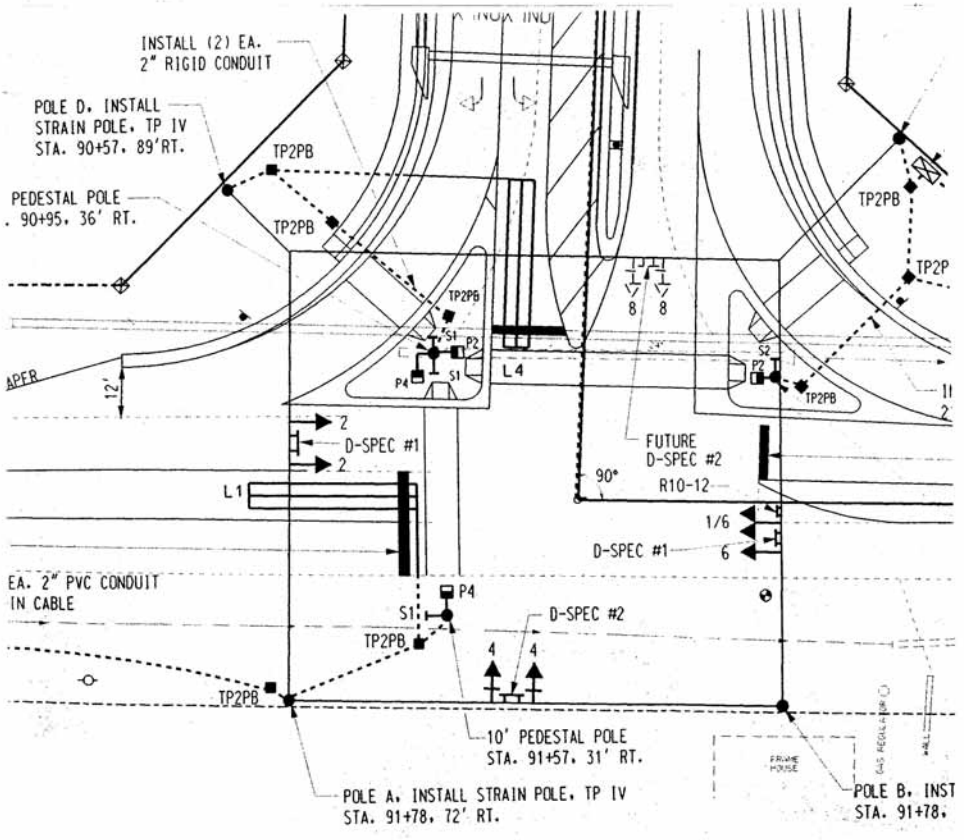

1 in=2.54 cm. 1 ft=0.3 m

Figure 11-19. Illustration. Example traffic signal plan, Superior Parkway construction plans, Lawrenceville, GA.

Develop a plan to install pedestrian signals and related improvements for an intersection in your community. The plan should be developed using nomenclature and reference standards from your State DOT. A list of standard drawings for pedestrian facility construction from California Department of Transportation (Caltrans) was previously provided in exercise 10.10. If possible, you should obtain an intersection drawing from your local traffic engineering department. This drawing typically shows the location of existing roadway features, travel lanes, signal equipment, and utilities. In addition to preparing a plan of proposed improvements, develop an estimate of quantities needed for each construction item and prepare an engineer's construction cost estimate. You will need to utilize the following resources:

- Plan view drawing of local intersection.
- Standard drawings (periodically published document).
- Standard specifications (periodically published document).
- Bid item numbers (typically a published list).
- Statewide average bid summary (typically assembled several times a year).

11.12 References and Additional Resources

The references for this lesson are:

1. MUTCD, FHWA, Washington, DC, 2003, available online at <http://mutcd.fhwa.dot.gov>, accessed April 22, 2004.
2. *Guide for the Planning, Design, and Operation of Pedestrian Facilities*, AASHTO, Washington, DC, July 2004.
3. *Design and Safety of Pedestrian Facilities—A Recommended Practice of the ITE*, ITE, Washington, DC, 1998, available online at http://safety.fhwa.dot.gov/ped_bike/docs/designsafety.pdf.
4. *Implementing Pedestrian Improvements at the Local Level*, FHWA, Publication No. FHWA-98-138, Washington, DC, 1998, available online at http://safety.fhwa.dot.gov/ped_bike/docs/localpedguide.pdf.
5. *Oregon Bicycle and Pedestrian Plan: An Element of the Oregon Transportation Plan*, Oregon Department of Transportation, 1995.
6. Vermont Statutes Online, <http://www.leg.state.vt.us/statutes/statutes2.htm>, accessed August 12, 2005.
7. KINNEY v. YERUSALEM, No. 93-1168, available online at <http://www.usdoj.gov/crt/foia/pa2.txt>, accessed August 12, 2005.
8. Lalani, N., "Alternative Treatments for At-Grade Pedestrian Crossings," *Informational Report*, Pedestrian and Bicycle Task Force, ITE, Washington, DC, 2001.
9. *Planning and Implementing Pedestrian Facilities in Suburban and Developing Rural Areas*, NCHRP Report 294A, NCHRP, TRB, Washington, DC, June 1987.
10. "A Comparison of the Pedestrian Safety of Median Islands and Marked Crossings," *Western Roads*, Western Australia, August 1978.

11. Zegeer, C.V., C. Seiderman, P. Lagerwey, M. Cynecki, M. Ronkin, and R. Schneider, *Pedestrian Facilities Users Guide—Providing Safety and Mobility*, Publication No. FHWA-RD-01-102, FHWA, McLean, VA, March 2002.
12. Taekratok, T., *Modern Roundabouts for Oregon*, Publication No. OR-RD-98-17, Oregon Department of Transportation, Salem, OR, June 1998, available online at <http://www.odot.state.or.us/techserv/engineer/pdu/Modern%2520Roundabouts.pdf>, accessed March 23, 2004.
13. Robinson, B.W., L. Rodegerdts, W. Scarborough, W. Kittleson, et al., *Roundabouts: An Informational Guide*, Publication No. FHWA-RD-00-067, FHWA, McLean, VA, June 2002, available online at <http://www.tfhrc.gov/safety/00068.htm>, accessed March 24, 2004.

Additional resources for this lesson include:

- *Pedestrian Access to Modern Roundabouts: Design and Operational Issues for Pedestrians who are Blind*, August 2003, available online at <http://www.access-board.gov/research&training/roundabouts/bulletin.htm>.

LESSON 12:

MIDBLOCK CROSSINGS

12.1 Introduction

Designers often assume that pedestrians will cross roadways at established intersections. However, observation of pedestrian behavior clearly indicates that people routinely cross at midblock locations. Pedestrians will rarely go out of their way to cross at an intersection unless they are rewarded with a much improved crossing—most will take the most direct route possible to get to their destination, even if this means crossing several lanes of high-speed traffic.

Well-designed midblock crossings can actually provide many safety benefits to pedestrians when placed in proper locations. This chapter discusses those benefits and explains several basic design principles for midblock crossings. The major sections of this lesson are as follows:

- 12.1 Introduction.
- 12.2 Background.
- 12.3 Medians and Refuge Islands—Powerful Safety Tools.
- 12.4 Advantages of Medians.
- 12.5 Design Considerations for Medians.
- 12.6 Midblock Crossings by Roadway Classification.
- 12.7 Midblock Crossing Design.
- 12.8 Staggered Midblock Crosswalks.
- 12.9 Midblock Crossing and Detection Technology.
- 12.10 Midblock Signals.
- 12.11 Grade-Separated Crossings.
- 12.12 Student Exercise.
- 12.13 References and Additional Resources.

12.2 Background

For most of this century—since pedestrians and motorists began competing for space—safety campaigns have directed pedestrians to walk to intersections to cross roadways. This is helpful advice, especially in downtown locations where signalization is frequent, where cycle lengths are short, where blocks are short, and where intersections are small and compact. But with the advent of the modern suburb, blocks are much longer, signalization is less frequent, some intersections are very wide, and vehicle speeds are much higher than in downtown areas. Under these conditions, crossing at intersections becomes less practical and often more dangerous.

Today's designer is challenged to find workable crossing points to move pedestrians across high-speed roadways. When convenient and manageable crossing points are not identified, most pedestrians cross at random, unpredictable locations. In making random crossings, they create confusion and add risk to themselves and drivers.

This chapter addresses several ways to facilitate nonintersection crossings: medians and refuge islands, midblock crossings, and grade-separated crossings. By placing medians along multilane roadways, the designer helps channel pedestrians to the best locations: where gaps are more frequent; where lighting is improved; and where motorists have the best chance to search, detect, recognize, and respond to the presence of pedestrians (see figure 12-1). Where there are medians, the pedestrian still may cross at random locations, but because of the increased frequency of acceptable gaps and greatly reduced conflicts, the pedestrian is more likely to find a longer gap and then walk (not rush) across the roadway.

Midblock crossings are an essential design tool. All designers must learn the best placement, geometrics, and operations of midblock crossings.



Figure 12-1. Photo. Midblock crossings are easily located on low-volume, low-speed roadways such as short collectors through neighborhoods.

12.3 Medians and Refuge Islands—Powerful Safety Tools

A median or refuge island is a raised longitudinal space separating the two main directions of traffic. Median islands, by definition, run one or many blocks. Refuge islands are much shorter than medians, with a length of 30.5–76.2 m (100–250 ft). Medians and refuge islands can be designed to block side-street or driveway crossings of the main road, as well as block left-turning movements. Because medians reduce turning movements, they can increase the flow rate (capacity) and safety of a roadway.

Medians have become an essential tool in minimizing the friction of turning and slowing vehicles. Medians maximize the safety of the motorist and pedestrian. Medians have been extensively studied by the Georgia and Florida DOTs. Based on more than 1609.3 centerline km (1,000 centerline mi) of conversion from two-way left-turn lanes (TWLTLs) to raised medians, motorist crashes were reduced dramatically. Florida DOT (FDOT) research has shown that pedestrians are at high risk while standing in TWLTLs.⁽¹⁾

Midblock crossings can be kept simple and are easily located on low-volume, low-speed [40.2–48.3 km/h (25–30 mi/h)] roadways such as short collectors through neighborhoods. When collectors are longer and handle more traffic and higher speeds, medians or refuge islands are helpful and sometimes essential (see figure 12-2). On multilane minor and major arterials, refuge islands or raised medians are essential. However, when used, crosswalks must be placed with great care in these locations, especially once travel speeds exceed 64.4 km/h (40 mi/h).

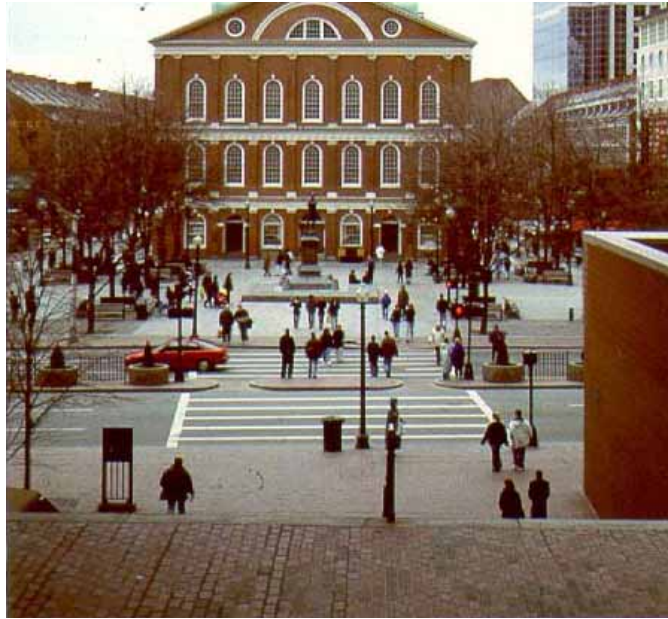

Figure 12-2. Photo. Refuge islands and visible crosswalks are essential on major arterials with higher traffic speeds.

12.4 Advantages of Medians

Medians separate conflicts in time and place. The pedestrian faced with one or more lanes of traffic in each direction must determine a safe gap in two, four, or even six lanes at a time. This is a complex task requiring accurate decisions. Younger and older pedestrians have reduced gap acceptance skills compared with pedestrians in other age groups. Pedestrians also typically have poor gap assessment skills at night. Many may predict that a car is 61.0 m (200 ft) off when, in fact, it is only 30.5 m (100 ft) away, far too close to attempt a crossing.

Medians Allow More Frequent Gaps

Not only do medians separate conflicts, but they also create the potential for acceptable gaps. On a standard-width, four-lane roadway with a center left-turn lane [19.5 m (64 ft) wide, with five 3.7-m (12-ft) lanes plus two 61.0-cm (24-in) gutter pans], it takes an average pedestrian traveling 1.2 m/s (4 ft/s) nearly 16 seconds to cross. Finding a safe 16-second gap in four moving lanes of traffic may be difficult or impossible. In any event, an attempt to cross may require a wait of 3–5 minutes. Faced with such a substantial delay, many pedestrians select a less adequate gap, run across the roadway, or stand in the center left-turn lane in hope of an additional gap. If a raised median is placed in the center, the pedestrian now crosses 7.9 m (26 ft) instead. This requires two 8-second gaps (see figures 12-3 and 12-4). These shorter gaps come more frequently. Based on traffic volume and the platooning effects from downstream signalization, the pedestrian may be able to find an acceptable gap in a minute or less.

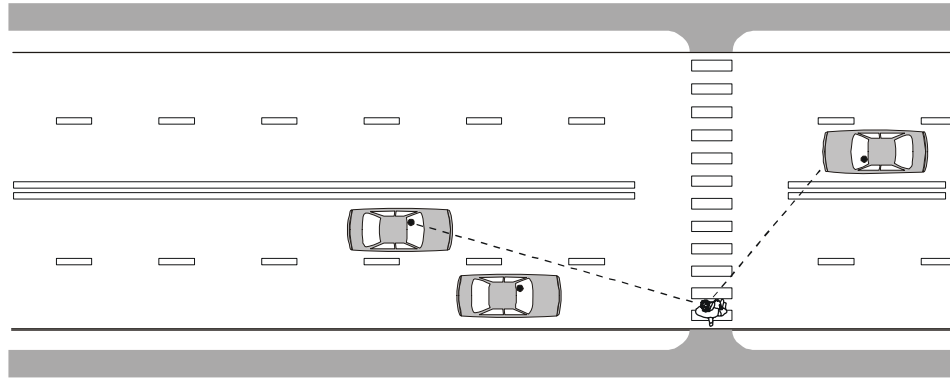

Figure 12-3. Photo. A midblock crossing without median refuge requires the pedestrian to look for gaps in both directions at once.

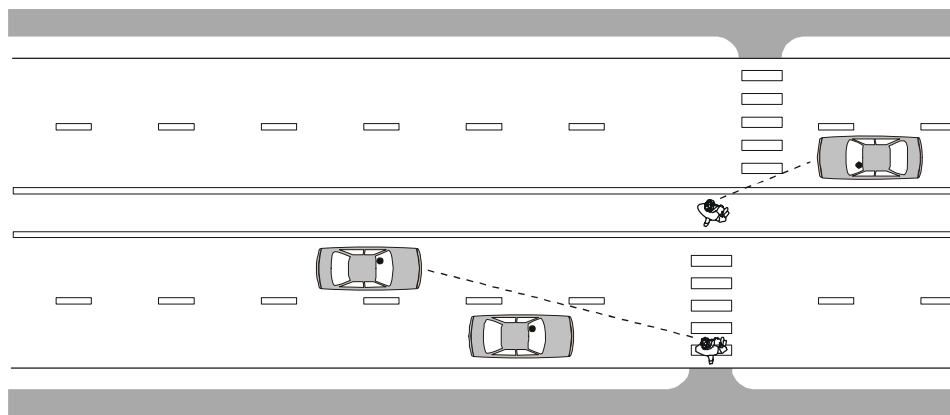

Figure 12-4. Photo. A midblock crossing with a median refuge allows the pedestrian to look for gaps in only one direction at a time.

Medians Are Less Expensive To Build

The reduced construction cost of a median versus a center left-turn lane comes as a surprise to many designers. Grass medians allow natural percolation of water, thus reducing drainage and water treatment costs. Medians do not require a base or asphalt. Curbing is essential in urban sections where medians are typically raised above the level of the street. In general, however, medians average a 5- to 10-percent reduction in materials and labor costs compared to a center left-turn lane.

Medians Are Less Expensive To Maintain

While there is only a slight savings in cost to build a raised median versus a center left-turn lane, there is a substantial savings in maintenance. An FDOT study compared 6.4 km (4 mi) of median versus center left-turn lane maintenance costs and found that medians save an average of 40 percent on maintenance costs based on a 20-year roadway life. More frequent resurfacing, such as every 7 to 9 years, would show much greater savings. This, too, surprises many designers. During the full life of the roadway asphalt, a raised median saves costs associated with sweeping accumulated debris, repainting lines, replacing raised pavement markers, and resurfacing lanes.

12.5 Design Considerations for Medians

Ideally, a median should be at least 2.4 m (8 ft) wide to allow the pedestrian to wait comfortably in the center, 1.2 m (4 ft) from moving traffic. A wider median is necessary if it must also serve the purpose of providing a left-turn bay for motor vehicle traffic at intersections. If the desired 2.4 m (8 ft) cannot be achieved, a width of 1.8 m (6 ft), or 1.2 m (4 ft) will be sufficient. To find the needed width, especially in a downtown or other commercial environment, consider narrowing travel lanes to an appropriate width. In most locations, this reduction in travel lanes can only be made to 3.4 m (11 ft), but in many other locations, where speeds are in the 32.2–48.3-km/h (20–30-mi/h) range, the reduction to 3.0 m (10 ft) or even 2.7 m (9 ft) is possible, and may even be desirable.

Medians typically have an open, flat cut and do not ramp up and down due to the short width. If the island is sufficiently large, then ramps approved by the ADA (1:12 grade) can be used. It is best to provide a slight grade (2 percent or less) to permit water and silt to drain from the area. Median cuts work best at midblock crossings.

12.6 Midblock Crossings by Roadway Classification

Midblock crossings are located and placed according to a number of factors, including roadway width, traffic volume, traffic speed and type, desired lines for pedestrian movement (see figure 12-5), and adjacent land use. Guidance for median placement on various types of roadways appears below.



Figure 12-5. Photo. Landscaping a median can block midblock access and divert pedestrians to adjacent intersections.

Local Roads

Due to their low traffic speed and volume, local roadways rarely have median treatments. Some exceptions may apply, especially around schools and hospitals, where traffic calming is desired, and in other unique locations.

Collector Roads

Two-lane collector roads occasionally have medians or refuge islands to channel pedestrians to preferred crossing locations. Used in a series, these refuge islands have a strong visual presence and act as significant devices to slow motorist travel through the corridor. A 16.1-km/h (10-mi/h) speed reduction (from 64.4 to 48.3 km/h (40 mi/h to 30 mi/h)) has been achieved. Pedestrians crossing at these midblock refuge islands with marked crosswalks (who also make their intent to cross known) achieve a nearly 100-percent favorable response from motorists.

When collector roads are widened to four lanes (not recommended), raised medians may be essential. A boulevard-style street with tree canopies is recommended. This canopy effect helps reduce travel speeds.

Multilane Arterial Highways with Four Lanes

Suburban crossings of four-lane roadways are greatly improved when medians and midblock crossings are used. On lower-volume roadways, it is best not to use signalization.

Signalization may be helpful or even essential under the following conditions:

- On higher volume roadways.
- Where gaps are infrequent.
- In school zones.
- Where elderly or disabled pedestrians cross.
- Where speeds are high.
- When a number of other factors are present.

Multilane Arterial Highways with Six or More Lanes

On multilane arterials with six or more lanes, merging is occurring, lane changing increases, and there is a greater tendency for motorists to speed and slow. This creates highly complex conditions that must be interpreted by the pedestrian.

At midblock locations, where vehicle speeds are high, signalization may be the only practical means of helping pedestrians to cross unless as part of a signal coordination scheme. At high speeds and with infrequent signal calls, high numbers of rear-end crashes can be anticipated. It is best not to allow urban area roadways to achieve high corridor speeds. This is especially true in areas where land use supports higher densities. The higher the speed, the greater the engineering challenge to cross pedestrians safely.

If a pedestrian crossing is needed in such a location, the designer must increase the devices used to alert the motorist. The standard pedestrian crossing and advanced crossing symbols with signs measuring 91 by 66 cm (36 by 26 in) are an absolute minimum for speeds of 64.4 km/h (40 mi/h) or greater. Pavement word symbols can be used as further enhancements. An enhanced crosswalk marking such as a zebra- or ladder-style crossing should be considered. Large overhead signs, flashing beacons, bulb-outs (see figure 12-6), and even flashing overhead signs have been successfully used in some locations.

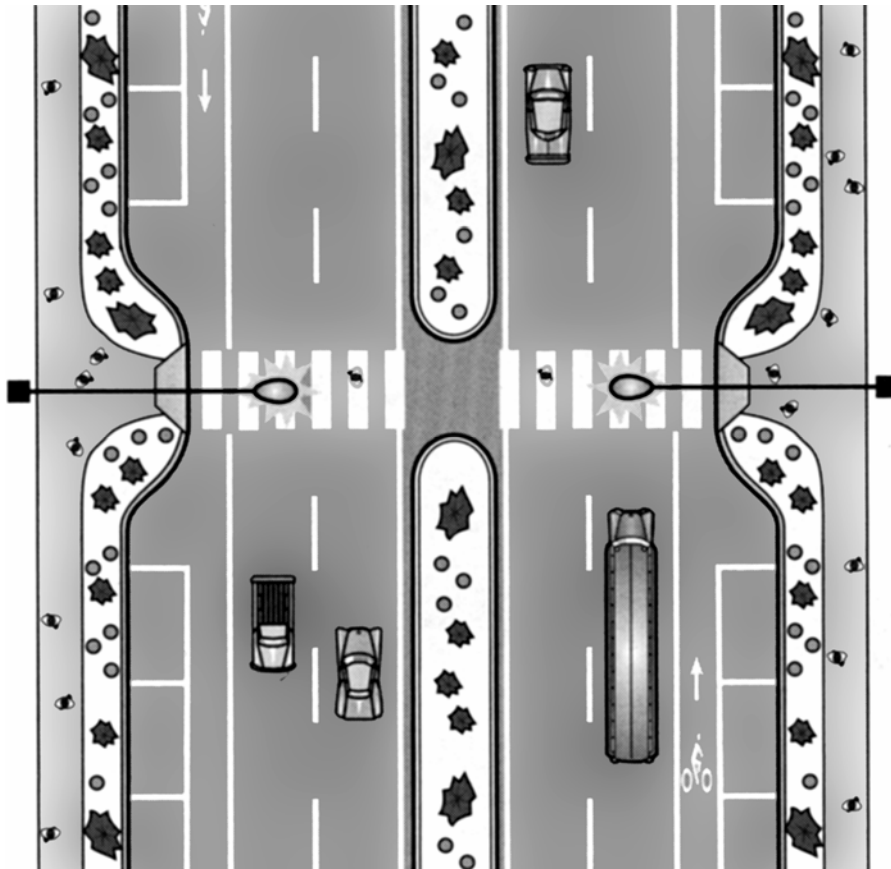

Figure 12-6. Illustration. Midblock crossing curb extensions provide better visibility for motorists and pedestrians.

12.7 Midblock Crossing Design

The design of midblock crossings makes use of warrants similar to those used for standard intersections. Stopping sight distances, effects of grade, cross slope, the need for lighting, and other factors all apply. The design considerations for medians are covered earlier in this lesson. However, there are a number of added guidelines that must be followed.

Connect Desire Lines

All other factors considered, pedestrians and bicyclists have a strong desire to continue their intended path of travel. Look for natural or existing patterns. Use of a high-angle, time-lapse video camera to map pedestrian crossings quickly paints this location, if it is not already well known.

Lighting

Motorists need to see both the pedestrians who stand waiting to cross and those who are already crossing. Either direct or back lighting is effective. Some overhead signs such as in Portland, OR, and Seattle, WA, use overhead lights that identify the pedestrian crossing and also shine down on the actual crosswalk.

Grade-separated crossings at midblock or intersection locations are effective in a few isolated circumstances (see section 12.11 for a further discussion of grade-separated crossings). However, because

of their cost and their potentially low use, engineering studies should be conducted by experienced designers. If given a choice, on most roadways, pedestrians generally prefer to cross at grade.

12.8 Staggered Midblock Crosswalks

Staggered crosswalks (or Z-crossings) are treatments in which the crosswalk is split by a median and is offset on either side of the median. This configuration forces pedestrians to turn in the median and face oncoming traffic before turning again to cross the second half of the crosswalk. Notice in figure 12-7 how, in either walking direction, the pedestrian must turn slightly toward traffic before crossing. In order to curtail shortcutting and force pedestrians to follow the intended path, some medians may also have attractive fencing to corral pedestrians in the correct direction (see figure 12-8). One problem with staggered crosswalks is that they may present a challenge for visually impaired pedestrians who are thrown off course by changes in the direction of the walkway leading to the road. A solution is to provide detectable warnings and/or railings to help realign the pedestrian perpendicularly to the roadway just before the crossing.

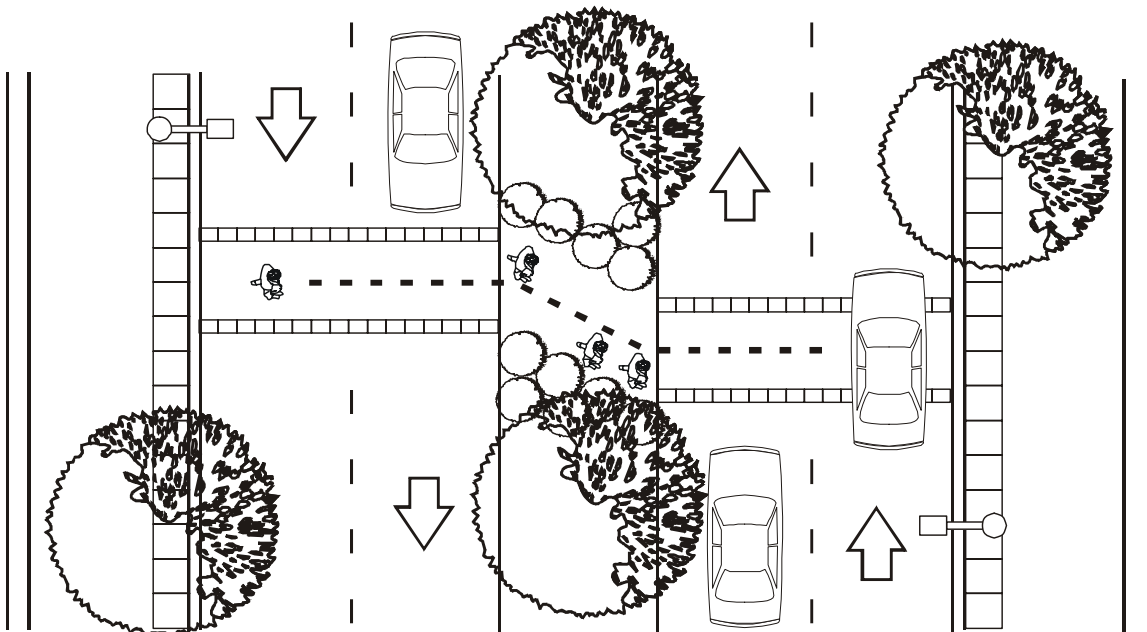

Figure 12-7. Illustration. Diagram of a staggered crossing configuration.

Source: *Southeast Neighborhood Traffic Management Plan*⁽²⁾



Figure 12-8. Photo. Staggered crosswalk with fencing.

Source: PBIC

Image Library, <http://www.pedbikeimages.org>⁽³⁾

12.9 Midblock Crossing and Detection Technology

Midblock crossings can be enhanced and made safer by the installation of some of the same crossing and detection technology found at intersections and other walkway locations. Refer to these previous sections for a discussion of these technologies:

- Pavement markings and signing (lessons 10.4–10.8).
- In-pavement flashers (lesson 10.9, “ITS Technology”).
- Automated detection devices (lesson 10.9, “ITS Technology”).
- Street lighting (lesson 9.5, “Ambience, Shade, and Other Sidewalk Enhancements”).
- Pavement surfaces and detectable warning (lesson 9.3, “Basic Sidewalk Elements”).
- Other crossing technologies (lesson 11.5, “Crossing and Detection Technology”).

12.10 Midblock Signals

The placement of midblock signals is called for in some locations. The warrants provided in the MUTCD should be followed. But even more caution must be provided for signalized midblock locations. Pedestrians feel frustrated if a signal is holding them back from crossing when there is an ample gap. Many will choose to cross away from the crossing, while others will dutifully push the activator button, not get an immediate response, and cross when there is a sufficient gap. A few seconds later, the approaching motorists must stop at a red signal for no reason, which can encourage motorist disrespect for the signal in the future.

Thus, the best signal setup for a midblock crossing is a hot (nearly immediate) response. As soon as the pedestrian call actuator button is pushed, the clearance interval should be activated. This minimal wait

time is a strong inducement for pedestrians to walk out of their way to use the crossing. Hot responses can often be used if the nearby signals are not on progression, or else a hot response may be permitted in off-peak hours. Midblock signals should be part of a coordinated system to reduce the likelihood of rear-end crashes and double cycles (i.e., two pedestrian cycles per one vehicle cycle at intersections to reduce pedestrian delay).

If a midblock signal system is used, it is important to place pedestrian pushbuttons in the median. There will be times when some pedestrians start too late or when older pedestrians lack time to cross, even at 0.9 m/s (3 ft/s). In these rare instances, the pedestrian needs to reactivate the signal.

12.11 Grade-Separated Crossings

According to the North Carolina DOT (NCDOT) *Bicycle Facilities Guide*, a grade-separated crossing “provides continuity of a bicycle/pedestrian facility over or under a barrier.”⁽⁴⁾

A grade-separated crossing such as a bridge/overpass or a culvert/underpass should be considered when a pedestrian facility meets a barrier like an active multitrack railroad, stream, or freeway (see figure 12-9).



Figure 12-9. Photo. An underpass continues this shared-use bicycle path beneath a four-lane highway with high traffic volume.

Source: *Bicycle Facilities Guide: Types of Bicycle Accommodations*⁽⁴⁾

Some principal planning concerns with grade-separated crossings are:

- This type of facility can be expensive and difficult to implement. For these reasons, advance planning, identification of a source of funds, and a compelling purpose and need are primary factors in obtaining approval for construction of bicycle/pedestrian bridges or underpasses.

- Bicycle/pedestrian grade separations to be included in State highway construction projects should already be identified in locally adopted bicycle or greenway master plans by the time a proposed highway improvement is in the early stages of development.
- Many bicyclists and pedestrians will not use an overpass that is inconvenient. Instead, pedestrians may choose a time-saving and sometimes more hazardous crossing. Fencing or other controls may be required to reinforce the safe crossing point.
- Grade crossings must be accessible; ramps, handrails, landings, etc., must be provided so the facility is accessible to all.

For a grade-separated crossing to be warranted, some of the following circumstances should be present:

- High pedestrian volumes at the location and a high demand to cross.
- A large number of young children who must regularly cross (particularly at locations near schools).
- High volumes of motor vehicles traveling at high speeds along the roadway.
- No convenient alternative crossing places nearby.
- Funding and a specific need for the overpass/underpass.
- An extreme hazard for pedestrians.

Section 7F.02 of the MUTCD states that “experience has shown that overpasses are more satisfactory than underpasses for pedestrian crossings, as overpasses are easier to maintain and supervise.”⁽⁵⁾ When deciding on the use of an overpass or underpass, be aware of the need to provide artificial lighting to reduce potential crime. Also, pay attention to the existing topography of the proposed site to “minimize changes in elevation for users of overpasses and underpasses and to help insure construction costs are not excessive.”⁽⁶⁾

12.12 Student Exercise

Choose an urban site that would be a good candidate for a midblock crossing with a pedestrian refuge island. Document the reasons that people often cross at this site (or would cross, given the opportunity). Photograph the site and prepare a sketch design solution.

12.13 References and Additional Resources

The references for this lesson are:

1. *Florida Pedestrian Planning and Design Guidelines*, Florida Department of Transportation, Tallahassee, FL, 1996, available online at http://www.dot.state.fl.us/Safety/ped_bike/handbooks_and_research/PEDHBTOC.PDF.
2. “Chapter 5: Neighborhood Street Design Guidelines,” *Southeast Neighborhood Traffic Management Plan (NTMP)*, City of Vancouver, WA, 2003, available online at <http://www.ci.vancouver.wa.us/transportation/ntmp/NTMTools/TOOL%2012%20-%20Mid-Block%20Crossing%20for%20Arterial%20Streets.pdf>, accessed May 18, 2004.
3. Image Library, PBIC, available online at <http://www.pedbikeimages.org>, accessed May 6, 2004.

4. *Bicycle Facilities Guide: Types of Bicycle Accommodations*, North Carolina Department of Transportation, Raleigh, NC, June 2003, available online at http://www.ncdot.org/transit/bicycle/projects/project_types/Grade_Separated_Crossing.pdf, accessed April 21, 2004.
5. MUTCD, FHWA, Washington, DC, 2003, available online at <http://mutcd.fhwa.dot.gov>, accessed April 22, 2004.
6. “Grade Separation Worksheet,” *Kane County Bicycle and Pedestrian Plan: Appendix J*, Kane County Division of Transportation, Geneva, IL, January 2003, available online at <http://www.co.kane.il.us/DOT/COM/Bicycle/outline.asp>, accessed April 21, 2004.

Additional resources for this lesson include:

- *Design and Safety of Pedestrian Facilities—A Recommended Practice of ITE*, ITE, Washington, DC 1998.
- *Oregon Bicycle and Pedestrian Plan*, Oregon Department of Transportation, Salem, OR, 1995.

LESSON 13:

SELECTING BICYCLE FACILITY TYPES AND EVALUATING ROADWAYS

13.1 Introduction

Several different types of facilities can be provided for bicyclists on roadways. The appropriate bicycle facility type is often determined by factors such as roadway cross-section elements, vehicle traffic characteristics, and bicyclist skill level. Some of these same factors used to determine appropriate bicycle facility type can also be used to evaluate the bicycle compatibility or bicycle friendliness (also called bicycle LOS) of roads with or without special bicycle facilities. This lesson describes several approaches to selecting appropriate bicycle facility types and summarizes several methods used to evaluate the bicycle compatibility of roads.

The major sections of this lesson are as follows:

- 13.1 Introduction.
- 13.2 Overview of Bicycle Facility Selection.
- 13.3 AASHTO Guidance on Selecting Bicycle Facility Type.
- 13.4 Overview of Evaluating Roads for Bicyclists.
- 13.5 Bicycle Compatibility Index.
- 13.6 Bicycle LOS.
- 13.7 Student Exercise.
- 13.8 References and Additional Resources.

13.2 Overview of Bicycle Facility Selection

As will be presented in lessons 14 and 15, there are several basic bicycle facility types:

- **Shared roadway with regular lane width.** Bicyclists share the existing road with other vehicle traffic (the majority of road mileage in the United States falls into this category) (see figure 13-1).
- **Wide curb lane.** Bicyclists share a wide outside (curb) lane with other vehicle traffic (see figure 13-2).
- **Bike lane.** Bicyclists have dedicated road space that is adjacent to but separated from other vehicle traffic lanes (see figure 13-3).
- **Separated path or lane.** Bicyclists have dedicated paths and trails (or sometimes very wide lanes) that offer significant separation from other vehicle traffic (see figure 13-4).



Figure 13-1. Photo. Bicyclist on a shared roadway.



Figure 13-2. Photo. Bicyclists in a wide curb lane.



Figure 13-3. Photo. Bicyclist in a bike lane.



Figure 13-4. Photo. Bicyclists and pedestrians on a separated (shared-use) path.

(These pictures show bicyclists not wearing helmets. FHWA strongly recommends that all bicyclists wear helmets.)
 Source for all images: PBIC Image Library, <http://www.pedbikemages.org>⁽¹⁾

Technical information on the design of these different bicycle facilities has dramatically improved in recent years. The 1999 AASHTO *Guide for the Development of Bicycle Facilities* is more than twice the size of previous editions and is based on considerably more research and practice than earlier versions.⁽²⁾ Many State and local agencies have adopted their own design practices that exceed recommendations in the 1999 AASHTO *Guide* for such things as bike lane width, trail width, and intersection treatments.

However, there is still considerable debate over the appropriate choice of bicycle facility type in any given set of circumstances. When is a striped bike lane the appropriate design solution rather than a simple shared lane or a multiuse path? At what traffic speed or volume does a shared lane cease to provide the level of comfort sought by most bicyclists?

A review of bicycle facility selection approaches by King found many differences, particularly between guidelines in the United States versus those used in Europe.⁽³⁾ The review did not find universal agreement among the U.S. guidelines, but it does point to some general ranges in which facility selection decisions can be made. The review concluded that engineering judgment and planning experience will continue to be vital elements in selecting appropriate bicycle facility types.

Nearly all of the facility selection approaches in the King review were based on at least two common variables:

1. Traffic volumes (typically ADT volume).
2. Traffic speed (typically 85th percentile speed or speed limit).

Many of the approaches had other variables that were considered but were not common among all other approaches.

Despite the many differences between the facility selection guidelines, the King review did present an aggregate or composite chart that attempts to represent all guidelines from North America on a single chart (see figure 13-5). This composite chart points to clear trends among all guidelines:

- Shared roads (also referred to as normal lanes) are recommended where traffic volumes and speeds are low.
- Wide curb lanes are recommended where traffic volumes and speeds are moderate.
- Bicycle lanes are recommended where traffic volumes and speeds are high.

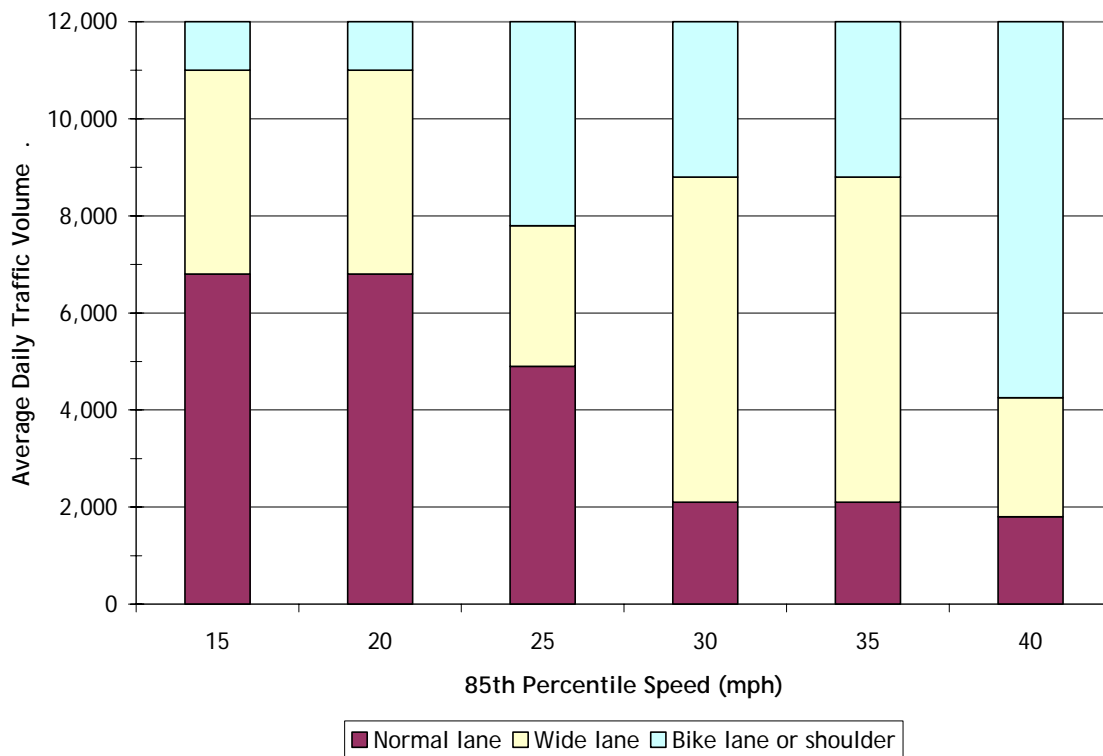

1 mi/h=1.61 km/h

Figure 13-5. Bar chart. A composite chart of numerous approaches to bicycle facility selection.

Source: Bicycle Facility Selection: A Comparison of Approaches⁽³⁾

13.3 AASHTO Guidance on Selecting Bicycle Facility Type

The 1999 AASHTO *Guide* provides some qualitative guidance on choosing the appropriate facility type, but largely suggests that bicycle facility selection is a policy decision to be made by State and local agencies. The facility selection guidance is largely centered on the skill levels of bicyclists and what types of facilities they prefer. The 1999 AASHTO *Guide* defines three bicycle user types (these were first defined in a 1994 FHWA report):^(2,4)

1. Type A (Advanced).
2. Type B (Basic).
3. Type C (Children).

The following descriptions are from the 1999 AASHTO *Guide*:⁽²⁾

Advanced or experienced riders are generally using their bicycles as they would a motor vehicle. They are riding for convenience and speed and want direct access to destinations with a minimum of detour or delay. They are typically comfortable riding with motor vehicle traffic; however, they need sufficient operating space on the traveled way or shoulder to eliminate the need for either themselves or a passing motor vehicle to shift position.

Basic or less confident adult riders may also be using their bicycles for transportation purposes, e.g., to get to the store or to visit friends, but prefer to avoid roads with fast and busy motor vehicle traffic unless there is ample roadway width to allow easy overtaking by faster motor vehicles. Thus, basic riders are comfortable riding on neighborhood streets and shared-use paths and prefer designated facilities such as bike lanes or wide shoulder lanes on busier streets.

Children, riding on their own or with their parents, may not travel as fast as their adult counterparts but still require access to key destinations in their community, such as schools, convenience stores and recreational facilities. Residential streets with low motor vehicle speeds, linked with shared-use paths and busier streets with well-defined pavement markings between bicycles and motor vehicles, can accommodate children without encouraging them to ride in the travel lane of major arterials.

These definitions suggest that bicyclists with different skill levels will prefer certain facility types. Advanced bicyclists, because of their advanced skills, desire for speed, convenience, and direct access, prefer direct routes that may also carry significant vehicle traffic, without any dedicated space for bicyclists. Children, however, prefer shared residential roads with little traffic or separated paths. Because of these differing preferences, it may sometimes be difficult to accommodate all potential bicyclists' preferences.

The 1999 AASHTO *Guide* suggests that facility selection is dependent on many factors, including the bicyclist skill level, the specific corridor conditions, and facility cost. However, more specific information about balancing the preferences of bicyclists is not provided. The *Guide* does indicate that bicyclists may be provided with more than one option to meet the travel and access needs of all potential users. Further, the *Guide* indicates that continuity and consistency should be considered when providing bicycle facilities. For example, children bicyclists using a separated path to get to school should not have to cross a major arterial without some intersection controls. Similarly, shoulders and bike lanes should not end abruptly at difficult intersections or busy segments of highway.

13.4 Overview of Evaluating Roads for Bicyclists

An integral part of the planning process for bicycle facilities is an inventory of existing conditions. Most bicycle plans attempt to quantify how well the existing road network accommodates bicyclists. A variety of bicycle compatibility criteria have been developed since the early 1990s to quantify how compatible a roadway is for accommodating safe and efficient bicycle travel. Also included under the genre of bicycle compatibility criteria are bicycle stress levels, bicycle safety indices, bicycle suitability ratings, roadway condition indices, bicycle interaction hazard scores, and bicycle LOS. As the name indicates, bicycle compatibility criteria are somewhat analogous to the LOS criteria established in the *Highway Capacity Manual*, which engineers and planners commonly use to evaluate the quality of traffic flow on highways and streets.⁽⁵⁾

Bicycle compatibility criteria, like the LOS criteria, can be used to evaluate existing conditions and identify facility improvement needs. Bicycle compatibility criteria also can be used to determine those streets or highways that are most amenable to bicycle travel. Many studies have shown, for example, that most bicyclists typically prefer to use streets with low traffic volumes, low vehicle speeds, and wide travel lanes. A number of other factors or variables can be used in addition to these to determine the roadways most compatible for bicycle use and, therefore, most likely to elicit positive traveler response.

Several recent studies have identified roadway cross-section elements and traffic factors that affect bicyclists' perceptions of safety, comfort, and convenience. These factors have been tested and calibrated in real-world conditions to develop models that attempt to quantify bicyclist comfort levels (based mostly on perceptions of safety). Numerous models have been developed, but the following two appear to be most commonly used in bicycle planning and facility selection:

- **Bicycle Compatibility Index (BCI).** Used to “evaluate the capability of specific roadways to accommodate both motorists and bicyclists.”⁽⁶⁾ This model was developed as part of an FHWA study and involved data collection from 200 persons in three different States.
- **Bicycle LOS.** Used to evaluate “...the bicycling conditions of shared roadway environments.”⁽⁷⁾ This model was developed using 150 persons in Florida; however, the model has been calibrated and extensively tested in numerous other locations.

13.5 Bicycle Compatibility Index

A team of researchers developed BCI in the late 1990s to quantify the “bicycle friendliness” of roadways.⁽⁶⁾ BCI is calculated as shown in table 13-1. The significant variables include: the presence and width of a paved shoulder or bicycle lane; motor vehicle traffic volume and speed in adjacent lanes; the presence of motor vehicle parking; and the type of roadside development.

Table 13-1. Bicycle compatibility index model.

Source: *The Bicycle Compatibility Index: A LOS Concept, Implementation Manual*⁽⁶⁾

$$BCI = 3.67 - 0.966BL - 0.410BLW - 0.498CLW + 0.002CLV + 0.022SPD + 0.506PKG - 0.264AREA + AF$$

where:

BL = presence of a bicycle lane or paved shoulder greater than 0.9 m (1 ft) <i>No</i> = 0 <i>Yes</i> = 1	PKG = presence of a parking lane with more than 30 percent occupancy <i>No</i> = 0 <i>Yes</i> = 1
BLW = bicycle lane (or paved shoulder) width, m (to the nearest tenth)	AREA = type of roadside development <i>Residential</i> = 1 <i>Other type</i> = 0
CLW = curb lane width, m (to the nearest tenth)	AF = $f_t + f_p + f_{rt}$
CLV = curb lane volume, vehicles per hour (v/hr) in one direction	Where: AF = adjustment factors
OLV = other lane(s) volume—same direction, v/h	f_t = adjustment factor for truck volumes (see below)
SPD = 85th percentile traffic speed, km/h	f_p = adjustment factor for parking turnover (see below) f_{rt} = adjustment factor for right-turn volumes (see below)

Adjustment Factors

Hourly Curb Lane Large Truck Volume ^a	f_t	Parking Time Limit (minutes (min))	f_p
≥ 120	0.5	≤ 15	0.6
60–119	0.4	16–30	0.5
30–59	0.3	31–60	0.4
20–29	0.2	61–120	0.3
10–19	0.1	121–240	0.2
< 10	0.0	241–480	0.1
		> 480	0.0
Hourly Right-Turn Volume ^b	f_{rt}		
≥ 270	0.1		
< 270	0.0		

Notes: ^a Large trucks are defined as all vehicles with six or more tires.

^b Includes total number of right turns into driveways or minor intersections along a road segment.

In developing BCI, the research team used the perspectives of more than 200 persons in 3 cities (Olympia, WA; Austin, TX; and Chapel Hill, NC) to subjectively evaluate the perceived bicycling comfort level in different roadway environments. The approach used in this study relied on participants viewing roadway segments on videotape; the videotape method was validated with an on-street pilot study using 24 participants and 13 different roadway segments. After viewing the videotape for a particular roadway segment, each of the 200+ participants in the larger study were asked to grade the segment viewed on a numerical scale of 1 to 6 (corresponding to LOS rankings of A to F).

The BCI method has been developed to allow practitioners to evaluate existing facilities to determine what improvements may be required, as well as determine the geometric and operational requirements for new bicycle facilities.

where:

$$W_v = W_t \quad \text{if ADT} > 4,000 \text{ vehicles per day (veh/day)}$$

$$W_v = W_t (2 - 0.00025 \times \text{ADT}) \quad \text{if ADT} \leq 4,000 \text{ veh/day, and if the street/road is undivided and unstriped}$$

$$a_1: 0.507 \quad a_2: 0.199 \quad a_3: 7.066 \quad a_4: -0.005 \quad C: 0.760$$

where:

$$(a_1-a_4) = \text{coefficients established by the multivariate regression analysis.}$$

The bicycle LOS score resulting from the final equation is prestratified into service categories of A through F (A being the best and F, the worst), according to the ranges shown in table 13-2, which reflect users' perception of the road segments' LOS for bicycle travel. This stratification is in accordance with the linear scale established during the referenced research (i.e., the research project bicycle participants' aggregate response to roadway and traffic stimuli). The model is particularly responsive to factors that are statistically significant. An example of its sensitivity to various roadway and traffic conditions is shown in figure 13-7.

Table 13-2. Bicycle LOS categories.

Source: Bicycle LOS Software User's Manual⁽⁸⁾

LOS	Bicycle LOS Score
A	≤ 1.5
B	> 5.5
C	> 4.5 and ≤ 5.5
D	> 3.5 and ≤ 4.5
E	> 2.5 and ≤ 3.5
F	> 1.5 and ≤ 2.5

Because the model represents the comfort level of a hypothetical typical bicyclist, some bicyclists may feel more or less comfortable than the bicycle LOS calculated for a roadway. A poor bicycle LOS grade does not mean that bikes should be prohibited on a roadway.

The bicycle LOS model is used by planners, engineers, and designers throughout the United States and Canada in a variety of planning and design applications. Applications include:

1. Conducting a benefits comparison among proposed bikeway/roadway cross sections.
2. Identifying roadway restriping or reconfiguration opportunities to improve bicycling conditions.
3. Prioritizing and programming roadway corridors for bicycle improvements.
4. Creating bicycle suitability maps.
5. Documenting improvements in corridor or systemwide bicycling conditions over time.

Bicycle LOS = $a_1 \ln(\text{Vol}_{15}/\text{Ln}) + a_2 \text{SP}_t(1+10.38\text{HV})^2 + a_3(1/\text{PR}_5)^2 + a_4(W_e)^2 + C$				
where:	a_1 : 0.507	a_2 : 0.199	a_3 : 7.066	a_4 : -0.005 C: 0.760
T-statistics:	(5.689)	(3.844)	(4.902)	(-9.844)
Baseline inputs:				
ADT =	12,000 vpd	% HV =	1	L = 2 lanes
SP _p =	40 mph	W _e =	12 ft	PR ₅ = 4 (good pavement)
			<u>BLOS</u>	<u>% Change</u>
Baseline BLOS Score (Bicycle LOS)			3.98	N/A
Lane Width and Lane striping changes				
W _t =	10 ft		4.20	6% increase
W _t =	11 ft		4.09	3% increase
W _t =	12 ft	-- (baseline average) -----	3.98	no change
W _t =	13 ft		3.85	3% reduction
W _t =	14 ft		3.72	7% reduction
W _t =	15 ft (W _l = 3 ft)		3.57 (3.08)	10%(23%) reduction
W _t =	16 ft (W _l = 4 ft)		3.42 (2.70)	14%(32%) reduction
W _t =	17 ft (W _l = 5 ft)		3.25 (2.28)	18%(43%) reduction
Traffic Volume (ADT) variations				
ADT =	1,000 Very Low		2.75	31% decrease
ADT =	5,000 Low		3.54	11% decrease
ADT =	12,000 Average - (baseline average) --		3.98	no change
ADT =	15,000 High		4.09	3% increase
ADT =	25,000 Very High		4.35	9% increase
Pavement Surface conditions				
PR ₅ =	2 Poor		5.30	33% increase
PR ₅ =	3 Fair		4.32	9% reduction
PR ₅ =	4 -- Good - (baseline average) - - -		3.98	no change
PR ₅ =	5 Very Good		3.82	4% reduction
Heavy Vehicles in percentages				
HV =	0 No Volume		3.80	5% decrease
HV =	1 --- Very Low - (baseline average) --		3.98	no change
HV =	2 Low		4.18	5% increase
HV =	5 Moderate		4.88	23% increase _a
HV =	10 High		6.42	61% increase _a
HV =	15 Very High		8.39	111% increase _a

Figure 13-7. Equation. Bicycle LOS sensitivity analysis.

Source: Bicycle LOS Software User's Manual⁽⁸⁾

13.7 Student Exercise

Select a variety of local streets, and assemble their traffic and geometric data (you may estimate certain data if none are available). With the information at hand, evaluate LOS of the roadways, and make recommendations for additional bike facilities.

13.8 References and Additional Resources

The references for this lesson are:

1. Image Library, PBIC, available online at <http://www.pedbikeimages.org>, accessed May 6, 2004.
2. *Guide for the Development of Bicycle Facilities*, AASHTO, Washington, DC, 1999.
3. King, M., *Bicycle Facility Selection: A Comparison of Approaches*, PBIC, University of North Carolina, Chapel Hill, NC, August 2002, available online at http://www.bicyclinginfo.org/de/bike_selection.htm, accessed May 5, 2004.
4. *Selecting Roadway Design Treatments to Accommodate Bicycles*, Publication No. FHWA-RD-92-073, FHWA, Washington, DC, January 1994, available online at http://safety.fhwa.dot.gov/ped_bike/docs/select.pdf.
5. *Highway Capacity Manual*, TRB, National Research Council, Washington, DC, 2000.
6. Harkey, D.L., D.W. Reinfurt, and A. Sorton, *The Bicycle Compatibility Index: A Level of Service Concept, Implementation Manual*, Publication No. FHWA-RD-98-095, FHWA, Washington, DC, December 1998, available online at <http://www.hsrc.unc.edu/research/pedbike/98095/index.html>.
7. Landis, B.W., V.R. Vattikuti, and M.T. Brannick, "Real-Time Human Perceptions: Toward a Bicycle Level of Service," *Transportation Research Record* 1578, TRB, 1997, available online at http://www.dot.state.fl.us/planning/systems/sm/los/pdfs/BLOS_TRBscanned.pdf
8. *Bicycle LOS Software User's Manual*, Sprinkle Consulting, Inc., Tampa, FL no date.

LESSON 14:

SHARED ROADWAYS

14.1 Introduction

As indicated in lesson 13, there are a variety of ways to accommodate bicyclists on roadways. In many cases, a few simple construction projects can make a big difference for bicyclists, such as replacing unsafe drain grates, filling potholes, or maintaining roadway shoulders so that they are free of debris.

This lesson provides information on shared roadways, which can encompass the following:

- Regular roads and streets with no special bicycle provisions.
- Wide curb lanes.
- Roadway shoulders or shoulder bikeways.
- Designated bicycle routes.
- Bicycle boulevards.

The major sections of this lesson are as follows:

- 14.1 Introduction.
- 14.2 Shared Roadways.
- 14.3 Wide Curb Lanes.
- 14.4 Roadway Shoulder or Shoulder Bikeways.
- 14.5 Designated Bicycle Routes.
- 14.6 Bicycle Boulevards.
- 14.7 Other Design Considerations.
- 14.8 Practices to Avoid.
- 14.9 Student Exercise.
- 14.10 References and Additional Resources.

This lesson has been primarily derived from the *Oregon Bicycle and Pedestrian Plan*, a statewide policy, planning, and design manual for the Oregon Department of Transportation (ODOT) in 1995.⁽¹⁾ Additional information has been gathered from the 1999 AASHTO *Guide for the Development of Bicycle Facilities*, which is abbreviated in this lesson as the *AASHTO Guide*.⁽²⁾

14.2 Shared Roadways

Since bicyclists are legally able to use nearly all roadways, the great majority of road mileage can be technically classified as shared roadways (see figure 14-1). The exception for shared roadways are where bicycling has been expressly prohibited by an ordinance or law, such as on some city streets or controlled-access freeways in some States. The 1999 AASHTO *Guide* defines a shared roadway as “a roadway which is open to both bicycle and motor vehicle travel. This may be an existing roadway, street with wide curb lanes, or a road with paved shoulders.”⁽²⁾

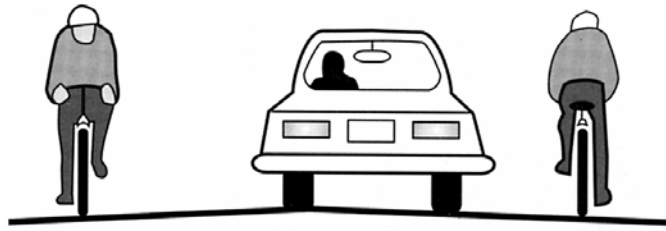

Figure 14-1. Illustration. Shared roadways include most existing roads and streets.

Source: Oregon Bicycle and Pedestrian Plan⁽¹⁾

In the United States, most shared roadways have no provisions for bicycle travel and are perceived by many bicyclists to be unsafe or at least uninviting. However, there are some design measures that can be taken to ensure that shared roadways accommodate bicyclists safely and efficiently. This lesson describes several design options for shared roadways, including wide curb lanes, shoulder bikeways, and bicycle boulevards. There is also a discussion of practices to be avoided, such as sidewalk bikeways.

There are no specific bicycle standards for most shared roadways; they are simply the roads that currently exist as local urban or rural roads and highways. Mile for mile, shared roadways are the most common bikeway type. Shared roadways are suitable in urban areas on streets with low speeds—40 km/h (25 mi/h) or less—or low traffic volumes (3,000 vehicles per day or less, depending on speed and land use).

In rural areas, the suitability of a shared roadway decreases as traffic speeds and volumes increase, especially on roads with poor sight distances. Where bicycle use or demand is potentially high, roads should be widened to include paved shoulders or shoulder bikeways if the travel speeds and volumes on the roadway are high.

Many urban local streets carry excessive traffic volumes at speeds higher than they were designed to carry. These can function as shared roadways if traffic speeds and volumes are reduced. There are many traffic calming techniques that can make these streets more amenable to bicycling on the road.

14.3 Wide Curb Lanes

A wide curb lane may be provided where there is inadequate width to provide bike lanes or shoulder bikeways. This may occur on retrofit projects where there are severe physical constraints and all other options have been pursued, such as removing parking or narrowing travel lanes. Wide curb lanes can often be installed by narrowing inner lanes on a multilane arterial, thereby reallocating roadway space so that the outside (curb) lanes are wider (see lesson 15 for roadway retrofit solutions). Wide curb lanes are not particularly attractive to most bicyclists, as they do not specifically designate road space for bicyclists. Wide curb lanes simply allow motor vehicles to pass bicyclists within a travel lane.

In general, 4.2 m (14 ft) of usable lane width is the recommended width for shared-use in a wide curb lane (see figures 14-2 and 14-3). Usable width is normally measured from the edge stripe to the centerline or adjacent lane stripe, and the gutter pan should not be included as usable width. A wider curb lane (up to 4.5 m (15 ft)) may be appropriate on steep grades where bicyclists need more maneuvering space. The increased width may also be appropriate in areas where drainage grates, raised reflectors, or other pavement features detract from usable width. With these exceptions in mind, wide curb lanes greater than 4.2 m (14 ft) that extend continuously may encourage two motor vehicles to share a lane, and are therefore not recommended. In situations where more than 4.5 m (15 ft) of pavement width exist, a bike lane or paved shoulder should be considered.

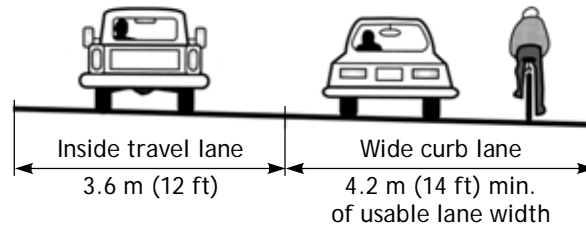

Figure 14-2. Illustration. Example of a wide curb lane.

Source: Oregon Bicycle and Pedestrian Plan⁽¹⁾



(This picture shows bicyclists not wearing helmets. FHWA strongly recommends that all bicyclists wear helmets.)

Figure 14-3. Photo. Motorists overtaking bicyclists in a wide curb lane.

A few cities in Canada and the United States (most notably Denver) have experimented with placing a bicycle symbol with an arrow along the right side of wide curb lanes at regular intervals (see figures 14-4 and 14-5). Called a hybrid bicycle lane, this bicycle facility has not been endorsed by the AASHTO *Guide* or other bicycle facility design manuals. The use of this bicycle pavement marking is suggested to offer the advantages of bicycle lanes along with many of the problems associated with bicycle lanes. Proponents of this treatment indicate that the bicycle symbol clearly indicates the right side of the wide curb lane for bicyclists, while also alerting motorists to the potential presence of bicyclists on the road.

There are currently no standards or guidance on how to deal with bus routes on shared roadway facilities having wide curb lanes. Extra space is needed for a bus to overtake a bicycle, so a wider curb lane (up to 4.5 m (15 ft)) may be appropriate. If both bus and bicycle traffic is significant, other alternatives besides a shared roadway should probably be considered. In some cities, a shared bus and bike lane accommodates both groups and ranges from 4.2 to 4.9 m (14 to 16 ft). Other cities have chosen to separate these two road users by providing separate bicycle and bus lanes.

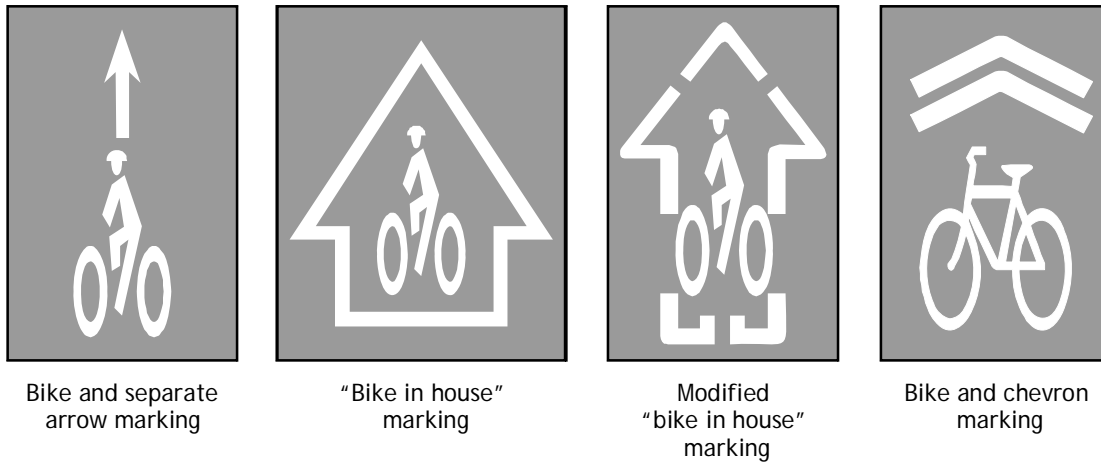

Figure 14-4. Illustrations. Various pavement markings for shared roadways and wide curb lanes.

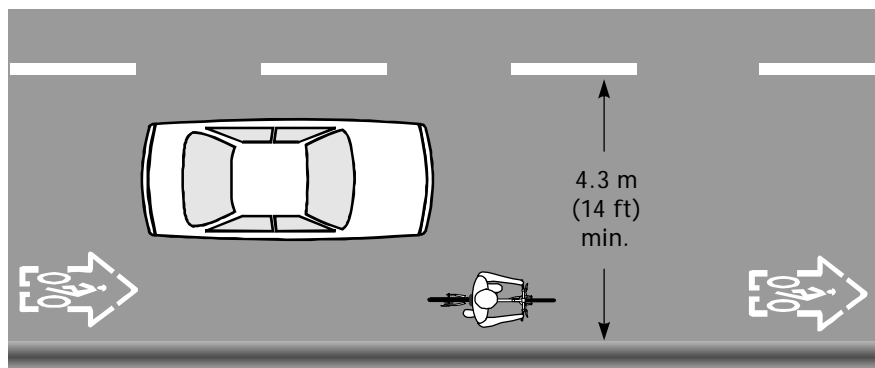

Figure 14-5. Illustration. Typical application of shared roadway pavement markings.

14.4 Roadway Shoulders or Shoulder Bikeways

Paved shoulders are provided on rural highways for a variety of safety, operational, and maintenance reasons:

- Space is provided for motorists to stop out of traffic in case of mechanical difficulty, a flat tire, or other emergency.
- Space is provided to escape potential crashes.
- Sight distance is improved in cut sections.
- Highway capacity is improved.
- Space is provided for maintenance operations such as snow removal and storage.
- Lateral clearance is provided for signs and guardrail.
- Storm water can be discharged further from the pavement.
- Structural support is given to the pavement.
- Paved shoulders, if they are adequately maintained, provide an excellent place for bicyclists to operate.

Width Standards

In general, the shoulder widths recommended for rural highways in AASHTO's *Policy on Geometric Design of Highways and Streets* serve bicyclists well, since wider shoulders are required on heavily traveled and high-speed roads and on those carrying large numbers of trucks.⁽³⁾

When providing paved shoulders for bicycle use, a minimum width of 1.2 m (4 ft) is recommended (see figure 14-6); however, even 0.6 m (2 ft) of shoulder width will benefit more experienced bicyclists. A shoulder width of 1.5 m (5 ft) is recommended from the face of guardrail, curb, or other roadside barriers.

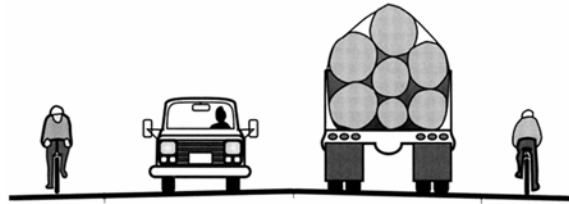

Figure 14-6. Illustration. Example of a paved shoulder or shoulder bikeway.

Source: Oregon Bicycle and Pedestrian Plan⁽¹⁾

Certain situations may require a wider paved shoulder. On steep grades, it is desirable to maintain a 1.8-m (6-ft) shoulder (minimum of 1.5 m (5 ft)), as cyclists need more space for maneuvering. A 1.8-m (6-ft) shoulder allows a cyclist to ride far enough from the edge of the pavement to avoid debris, yet far enough from passing vehicles to avoid conflict. If there are physical width limitations, a minimum width of 1.2 m (4 ft) from the longitudinal joint between a monolithic curb and gutter and the edge of travel lane may be adequate. Where high bicycle usage is expected, it is desirable to increase the shoulder width. Additional shoulder width may also be appropriate where vehicle speeds are greater than 80 km/h (50 mi/h), or where there is significant truck, bus, or recreational vehicle traffic.

Pavement Design

Many existing gravel shoulders have sufficient width and base to support shoulder bikeways. Minor excavation and the addition of 75 to 100 millimeters (mm) (3 to 4 in) of asphalt pavement is often enough to provide shoulder bikeways. It is best to widen shoulders in conjunction with pavement overlays for several reasons:

- The top lift of asphalt adds structural strength.
- The final lift provides a smooth, seamless joint.
- The cost is less, as greater quantities of materials will be purchased.
- Traffic is disrupted only once for both operations.

When shoulders are provided as part of new road construction, the pavement structural design should be the same as that of the roadway.

On shoulder widening projects, there may be some opportunities to reduce costs by building to a lesser thickness. A total of 50–100 mm (2–4 in) of asphalt and 50–75 mm (2–3 in) of aggregate over existing roadway shoulders may be adequate if the following conditions are met:

- There are no planned widening projects for the road section in the foreseeable future.
- The existing shoulder area and roadbed are stable and there is adequate drainage, or adequate drainage can be provided without major excavation and grading work.
- The existing travel lanes have adequate width and are in stable condition.
- The horizontal curvature is not excessive, so the wheels of large vehicles do not track onto the shoulder area (on roads that have generally good horizontal alignment, it may be feasible to build only the insides of curves to full depth).
- The existing and projected vehicle and heavy truck traffic is not considered excessive (e.g., heavy truck traffic less than 10 percent of total traffic).

The thickness of pavement and base material will depend upon local conditions, and engineering judgment should be used. If there are short sections where the travel lanes must be reconstructed or widened, these areas should be constructed to normal full-depth standards.

The Joint between the Shoulders and the Existing Roadway

The following techniques should be used to add paved shoulders to roadways where no overlay project is scheduled:

- **Saw Cutting.** A 0.3-m (1-ft) saw cut inside the existing edge of the pavement provides the opportunity to construct a good tight joint. This eliminates a ragged joint at the edge of the existing pavement (see figure 14-7).

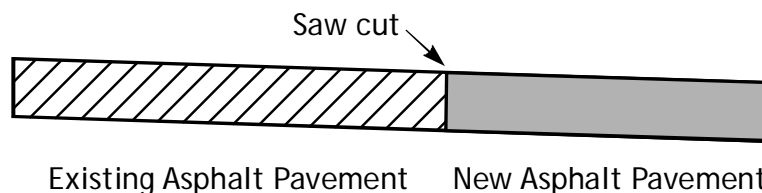

Figure 14-7. Illustration. Example of a saw-cut pavement joint.

Source: Oregon Bicycle and Pedestrian Plan⁽¹⁾

- **Feathering.** Feathering the new asphalt onto the existing pavement can work if a fine mix is used and the feather does not extend across the area traveled by bicyclists (see figure 14-8).

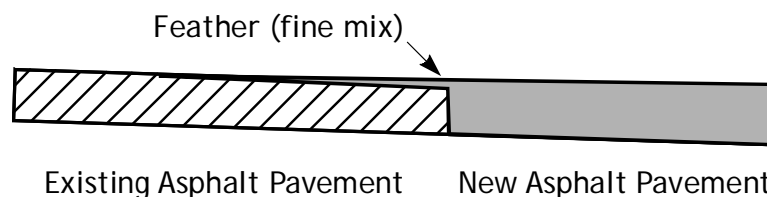

Figure 14-8. Illustration. Example of a feathered pavement joint.

Source: Oregon Bicycle and Pedestrian Plan⁽¹⁾

- **Grinding.** Where some shoulder width and thickness are already available, a pavement grinder can be used to make a clean cut at the edge of the travel lane, grade the existing asphalt to the right depth, and cast aside the grindings in one operation (see figure 14-9), with these advantages:

- Less of the existing pavement is wasted.
- The existing asphalt acts as a base.
- There will not be a full-depth joint between the travel lane and the shoulder.
- The grindings can be recycled as base for the widened portion.

New asphalt can then be laid across the entire width of the shoulder bikeway with no seams.

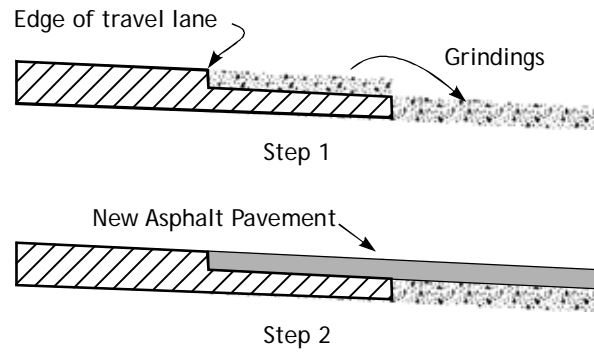

Figure 14-9. Illustration. Example of the use of grindings as pavement base.

Source: Oregon Bicycle and Pedestrian Plan⁽¹⁾

Gravel Driveways and Approaches

Wherever a highway is constructed, widened, or overlaid, all gravel driveways and approaches should be paved back 4.5 m (15 ft) to prevent loose gravel from spilling onto the shoulders (see figure 14-10).

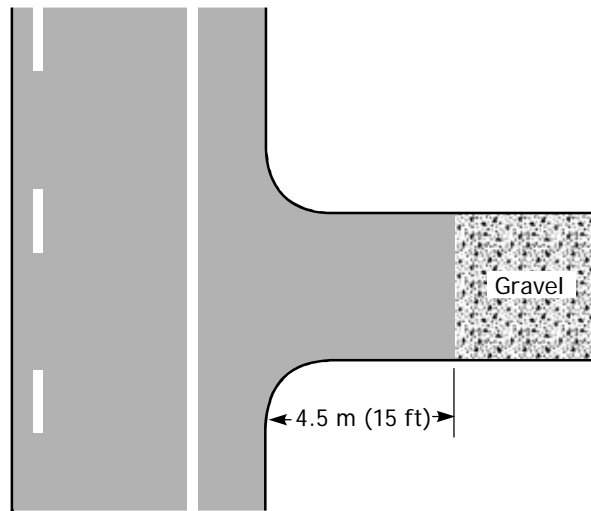

Figure 14-10. Illustration. A paved driveway apron reduces gravel on roadway shoulders.

Source: Oregon Bicycle and Pedestrian Plan⁽¹⁾

14.5 Designated Bicycle Routes

Bicycle routes are specially designated shared roadways that are preferred for bicycle travel for certain recreation or transportation purposes. The 1999 AASHTO *Guide* also refers to a designated bicycle route as a signed shared roadway and lists the following reasons for designating signed bike routes:

- The route provides continuity to other bicycle facilities such as bike lanes and shared-use paths.
- The road is a common route for bicyclists through a high-demand corridor.
- In rural areas, the route is preferred for bicycling because of low motor vehicle traffic volumes or paved shoulder availability.
- The route extends along local neighborhood streets and collectors that lead to internal neighborhood destinations, such as a park, school, or commercial district.

Bike route signs may also be used on streets with bike lanes, as well as on shared-use paths. Regardless of the type of facility or roadway on which they are used, it is recommended that bike route signs always include destination, direction, and distance information (see figure 14-11).

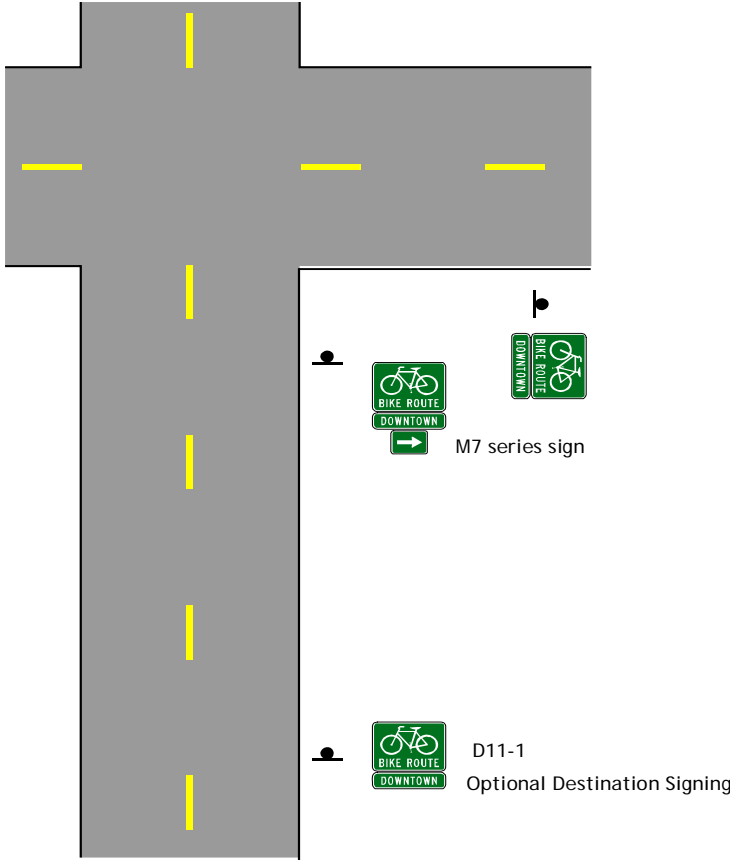

In urban areas, signs should be placed every 500 m (approx. 0.25 mile), at every turn, and at all signalized intersections.

Figure 14-11. Illustration. Typical signed shared route signing.

Source: American Association of State Highway and Transportation Officials ⁽²⁾

The signing of shared roadways indicates to bicyclists that there are particular advantages to using these routes compared to alternate routes. This means the responsible agencies have taken action to ensure that these routes are suitable as shared routes and will be maintained as such.

The following criteria should be considered prior to signing a route:

- The route provides through and direct travel in bicycle-demand corridors.
- The route connects discontinuous segments of shared-use paths, bike lanes, and/or other bike routes.
- An effort has been made to adjust traffic control devices (e.g., stop signs, signals) to give greater priority to bicyclists on the route, as opposed to alternative streets. This could include placement of bicycle-sensitive detectors where bicyclists are expected to stop.
- Street parking has been removed or restricted in areas of critical width to provide improved safety.
- A smooth surface has been provided (e.g., utility adjusted to grade, bicycle-safe drainage grates installed, potholes filled, etc.).
- The route will be maintained at sufficient intervals to prevent accumulation of debris (e.g., regular street sweeping).
- Wider curb lanes are provided compared to parallel roads.
- Shoulder or curb-lane widths meet or exceed width requirements for shared roadways (1.2-m (4-ft) shoulder; 4.2-m (14-ft) curb lanes).

14.6 Bicycle Boulevards

The bicycle boulevard is a refinement of the shared roadway concept in that the operation of a local street is modified to function as a through-street exclusively for bicycles while maintaining local access for automobiles. Traffic calming devices reduce traffic speeds and extensive through traffic. Traffic controls limit conflicts between motorists and bicyclists and give priority to through-bicycle movement.

Advantages of Bicycle Boulevards

- Opportunity—Traditional street grids offer many miles of local streets that can be converted to bicycle boulevards.
- Low cost—The major costs are for traffic control and traffic calming devices.
- Traffic calming techniques are increasingly favored by residents who want slower traffic on neighborhood streets.
- Bicycle travel on local streets is usually compatible with local land uses.
- Bicycle boulevards may attract new or inexperienced cyclists who do not feel comfortable on arterials and prefer to ride on lower traffic volume streets.
- Bicycle boulevards can improve conditions for pedestrians, with reduced traffic and improved crossings.

Disadvantages of Bicycle Boulevards

- They are often located on streets that do not provide direct access to commercial land uses and other destinations; some cyclists may have to negotiate a hostile street environment to complete a portion of their trip.
- If improperly implemented, they can cause traffic diversion onto other streets.
- Failure to provide arterial crossings can result in unsafe conditions for bicyclists.
- Traffic signals may be expensive or unacceptable for the traffic conditions.

Successful bicycle boulevard implementation requires careful planning with residents and businesses to avoid unacceptable impacts.

Elements of a Bicycle Boulevard

Several elements are typically considered in the design of a bicycle boulevard (see figure 14-12):

- Selecting a direct and continuous street, rather than a circuitous route that winds through neighborhoods. Bike boulevards work best on a street grid system.
- Turning stop signs toward intersecting streets so bicyclists can ride with few interruptions.
- Placing motor vehicle traffic diverters at key intersections to reduce traffic volumes (the diverters must be designed to allow through-bicycle movement).
- Placing traffic calming devices on streets to lower traffic speeds.
- Placing directional signs that route cyclists to key destinations, guide cyclists through difficult situations, and alert motorists to the presence of bicyclists.
- Providing protection where the boulevard crosses high-volume arterials:
 - Using signals where a traffic study has shown that a signal will be safe and effective in ensuring that bicyclists can activate it. Signal loops should be installed where bicyclists stop and should be supplemented with a pushbutton that does not require dismounting.
 - Using median refuges with gaps wide enough to allow bicyclists to pass through (minimum of 2.4 m (8 ft)). The median should be wide enough to provide a refuge (minimum of 3 m (10 ft)). The design should allow bicyclists to see the travel lanes they must cross.

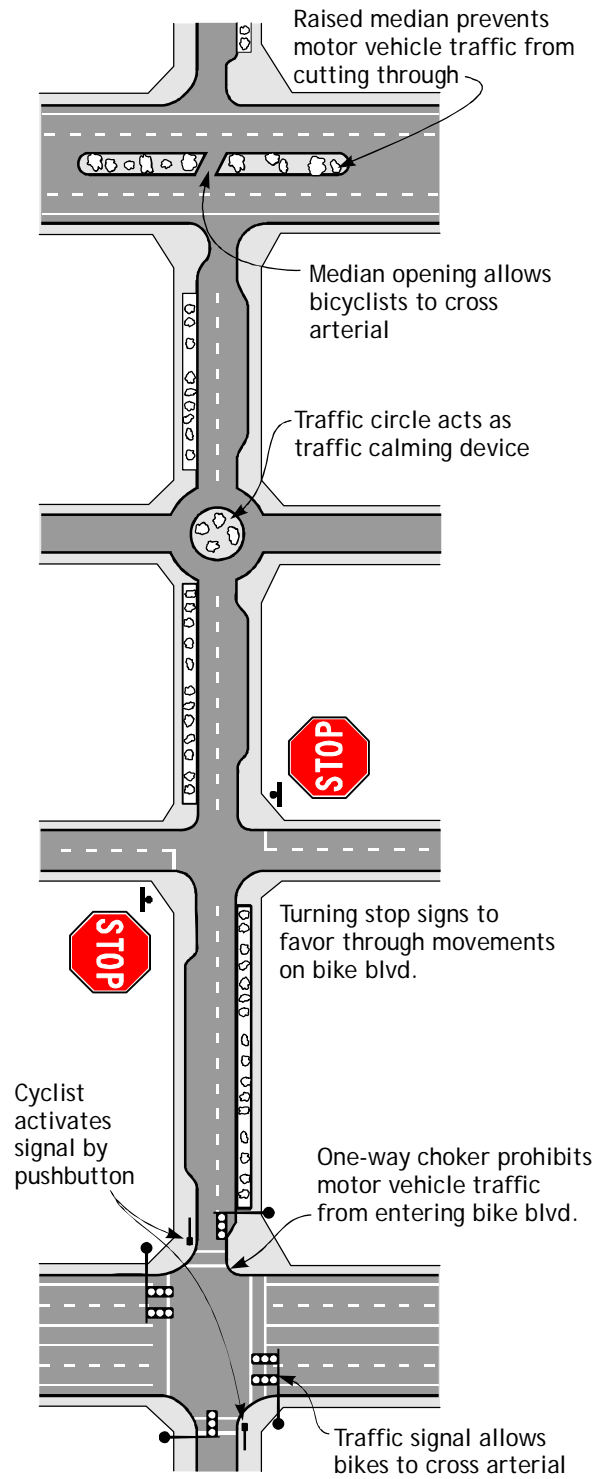

Figure 14-12. Illustration. Typical elements of a bicycle boulevard.

Source: Oregon Bicycle and Pedestrian Plan⁽¹⁾

14.7 Other Design Considerations

Rumble Strips

Rumble strips are provided to alert motorists that they are wandering off the travel lanes onto the shoulder or across the centerline on an undivided highway. They are most common on rural freeways, but are also being considered on other primary and secondary highways. One of a bicyclist's main concerns about rumble strips is the ability to control the bicycle when traveling across or along the rumble strip for such maneuvers as a left turn or to avoid debris or an obstacle on the paved shoulder. Travel to the right of the rumble strip is generally most beneficial for the bicyclist as long as that area is free of debris and obstacles and the travel path is wide enough to comfortably accommodate the bicycle.

According to the 1999 AASHTO *Guide*, rumble strips or raised pavement markers, where installed to warn motorists they are driving on the shoulder (or discourage them from doing so), are not recommended where shoulders are used by bicyclists unless there are:⁽²⁾

- A minimum clear path of 0.3 m (1 ft) from the rumble strip to the traveled way.
- 1.2 m (4 ft) from the rumble strip to the outside edge of paved shoulder (or 1.5 m (5 ft) to an adjacent guardrail, curb, or other obstacle).

If existing conditions preclude achieving the minimum desirable clearance, the width of the rumble strip may be decreased or other appropriate alternative solutions should be considered.

Additional guidance on rumble strips is provided by the FHWA:⁽⁴⁾

- Rumble strips should only be installed when an adequate unobstructed width of paved surface remains available for bicycle use. To aid a bicyclist's movement to the left of a shoulder rumble strip when needed to avoid debris, make turns, or avoid other shoulder users, some States provide periodic gaps of 3.0 m (10 ft) to 3.6 m (12 ft) between groups of the milled-in elements throughout the length of the shoulder rumble strip. A study by one State recommends a gap of 3.6 m (12 ft) between milled-in elements of 8.5 m (28 ft) to 14.6 m (48 ft) in length. Other States have specified 3.0 m (10 ft) gaps between 3.0-m (10-ft) milled-in elements.
- Small stones, sand, and other debris often collect on roadway shoulders. Usually the air turbulence caused by passing traffic will keep the portion of the shoulder closest to traffic relatively clear of such debris. For this reason, most bicyclists prefer to ride on that portion of the shoulder nearest to traffic to avoid debris. To provide a clear area beyond the rumble strip for bicycle travel, highway maintenance agencies should periodically sweep shoulders along identified bicycle routes and other routes with high bicycle usage.
- Recent studies by two States attempted to develop modified rumble strip designs that would be more acceptable to bicyclists. The principle adjustments to the milled-in strip elements considered were reduced depth, reduced width, and changes to the center-to-center spacing. Several types of raised elements have also been tested and evaluated. Both studies concluded that a reasonable compromise between maximum warning to errant motorists and tolerable discomfort to bicyclists was a reduced-depth, milled rumble strip.

Some highway agencies have instituted policies that prohibit the use of shoulder rumble strips on roads designated as bike routes or where there is insufficient paved shoulder room remaining to accommodate bicycle travel. Others evaluate the use of rumble strips on a case-by-case basis and often opt to install them only at locations with a history of run-off-road crashes.

Other designs being used or investigated employ a skip pattern of rumble strip that provides a smoother travel path throughout portions of the strip and thus allows bicyclists to move to the left when needed. Furthermore, some highway agencies are providing an aid to cyclists and all travelers in general by posting roadside signs, such as RUMBLE STRIPS AHEAD, alerting the traveler to the presence of the shoulder rumble strip.

ODOT uses a rumble strip design that meets the AASHTO guidelines (see figure 14-13): 400-mm (16-in) grooves are cut into the shoulder 150 mm (6 in) from the lane edge line. On a 2.4-m (8-ft) shoulder, this leaves 1.8 m (6 ft) of usable shoulder for bicyclists.

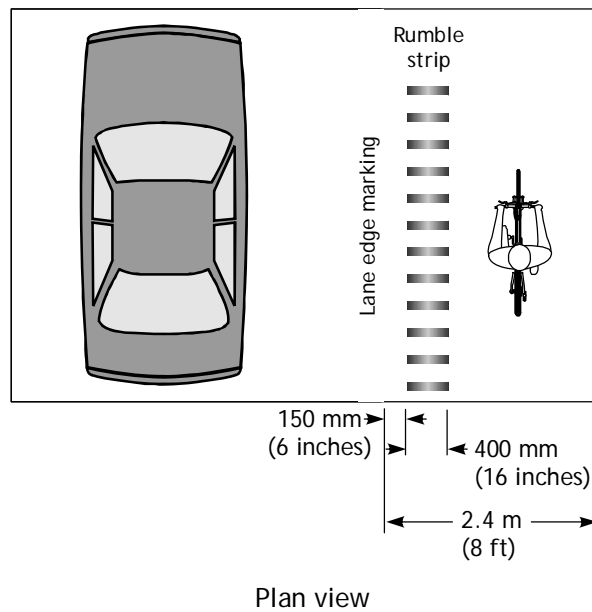
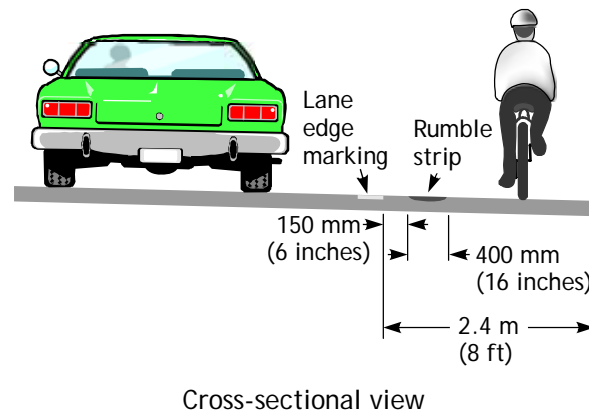

Figure 14-13. Illustration. Rumble strip guidance provided by ODOT.

Source: Oregon Bicycle and Pedestrian Plan⁽¹⁾

The following recommendations come from a Colorado DOT study.⁽⁵⁾ The standard type of ground-in rumble strips are 0.3 m (12 in) wide, with a groove depth of 9.5 mm ± 3 mm (0.375 in ± 0.125 in) ground in an interrupted pattern, and is the recommended configuration for asphalt rumble strips based on the data collected for this report. No recommendation is made concerning rolled-in concrete rumble strips.

In a study for the Pennsylvania DOT, the authors recommended two different “bicycle tolerable” rumble strip patterns:⁽⁶⁾

- For nonfreeway facilities with speeds greater than 88 km/h (55 mi/h):
 - Groove width of 127 mm (5 in).
 - Flat portion between cuts of 178 mm (7 in).
 - Depth of 10 mm (0.375 in).
- For nonfreeway facilities with speeds near 72 km/h (45 mi/h):
 - Groove width of 127 mm (5 in).
 - Flat portion between cuts of 152 mm (6 in).
 - Depth of 10 mm (0.375 in).

Drainage Grates

Care must be taken to ensure that drainage grates are bicycle-safe. If not, a bicycle wheel may fall into a slot in the grate, causing the bicyclist to fall. Replacing existing grates with bicycle-safe grates (see A and B in figure 14-14, preferred methods) or welding thin metal straps across the grate perpendicular to the direction of travel (see C in figure 14-14, alternate method) is required. These should be checked periodically to ensure that the straps remain in place.

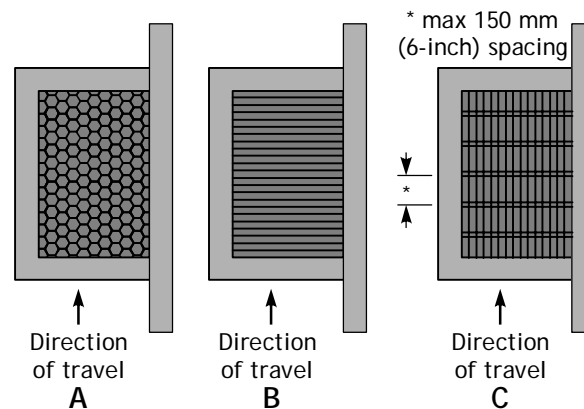

Figure 14-14. Illustration. Examples of bicycle-safe drainage grates.

Source: Oregon Bicycle and Pedestrian Plan⁽¹⁾

Note that grates with bars perpendicular to the roadway must not be placed at curb cuts, as wheelchairs could get caught in the slots. The most effective way to avoid drainage grate problems is to eliminate them entirely with the use of inlets in the curb face (see figure 14-15).

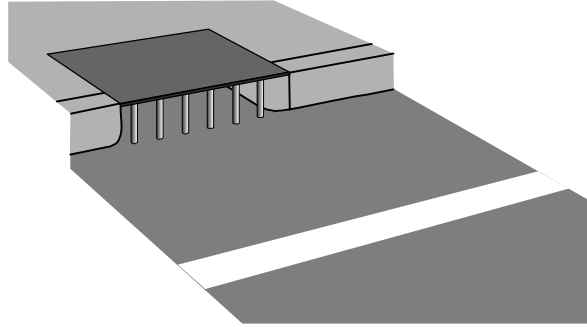

Figure 14-15. Illustration. Example of curb drainage inlet.

Source: Oregon Bicycle and Pedestrian Plan⁽¹⁾

If a street-surface grate is required for drainage, care must be taken to ensure that the grate is flush with the road surface. Inlets should be raised after a pavement overlay to within 6 mm (0.25 in) of the new surface. If this is not possible or practical, the pavement must taper into drainage inlets so they do not cause an abrupt edge at the inlet.

Railroad Crossings

Special care must be taken wherever a bikeway intersects railroad tracks. The most important improvements for bicyclists are smoothness, angle of crossing, and flange openings (see figure 14-16).

Smoothness. Concrete performs better than other materials under wet conditions and, when laid with precision, provides a smooth ride. Rubberized crossings provide a durable, smooth crossing, although they tend to become slippery when wet. If asphalt pavement is used, it must be maintained in order to prevent a ridge buildup next to the rails. Timber crossings wear down rapidly and are slippery when wet.

Angle of Crossing. The risk is kept to a minimum where the bikeway crosses the tracks at a 90° angle. If the skew angle is less than 45°, special attention should be given to the bikeway alignment to improve the angle of the approach, preferably to 60° or greater, so cyclists can avoid catching their wheels in the flange and losing their balance.

Flange Openings. The open flange area between the rail and the roadway surface can cause problems for bicyclists, since it can catch a bicycle wheel, causing the rider to fall. Flange width must be kept to a minimum.

Note that the combination of smoothness, angle, and flange opening creates conditions that affect bicyclists. By improving smoothness and flange opening, the angle becomes less critical.

Sidewalk Ramps on Bridges

Sidewalk ramps can help bicyclists if the bridge sidewalks are wide enough for bicycle use (minimum 1.2 m (4 ft), see figure 14-17). They should be provided where motor vehicle traffic volumes and speeds are high and the shoulders on the bridge are narrow.

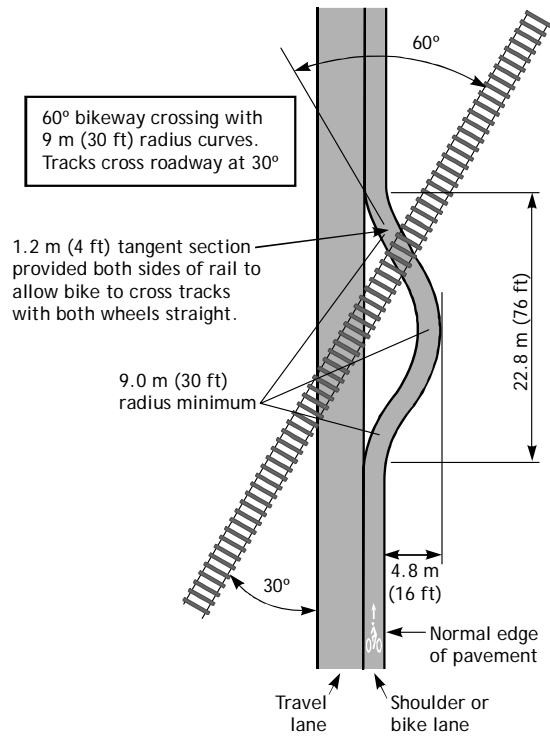

Figure 14-16. Illustration. Bike lane or shoulder crossing railroad tracks.

Source: Oregon Bicycle and Pedestrian Plan⁽¹⁾

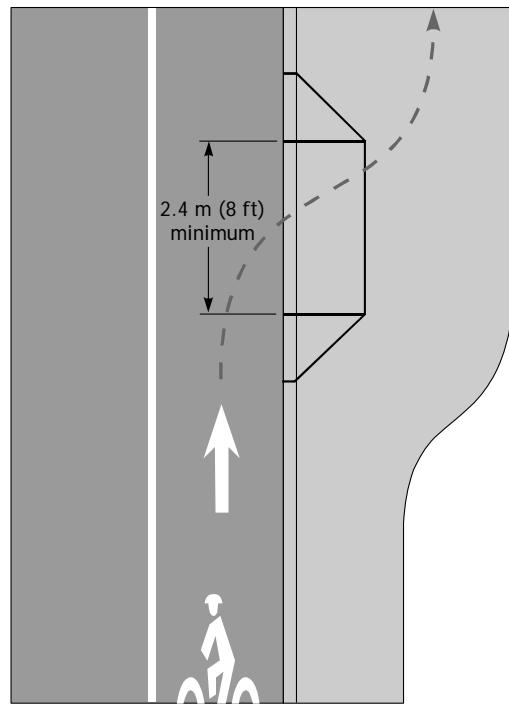

Figure 14-17. Illustration. Curb ramp provides access to sidewalk.

Source: Oregon Bicycle and Pedestrian Plan⁽¹⁾

14.8 Practices to Avoid

ODOT has more than 20 years of experience designing bikeways, and it has also learned from local city and county experiences. Several practices have proven to be poor ones, including sidewalk bikeways, extruded curbs, and raised pavement markings. These practices are discussed in this section.

Sidewalk Bikeways

Some early bikeways used sidewalks for both pedestrians and bicyclists. While in rare instances this type of facility may be necessary, or desirable for use by small children, in most cases it should be avoided.

Sidewalks are not suited for bicycling for several reasons:

- Bicyclists face conflicts with pedestrians.
- There may be conflicts with utility poles, sign posts, benches, etc.
- Bicyclists face conflicts at driveways, alleys, and intersections: A bicyclist on a sidewalk is generally not visible to motorists and may emerge unexpectedly. This is especially true of bicyclists who ride opposing adjacent motor vehicles.
- Bicyclists are put into awkward situations at intersections where they cannot safely act like a vehicle, but are not in the pedestrian flow either, which creates confusion for other road users.

Bicyclists are safer when they are allowed to function as roadway vehicle operators rather than as pedestrians.

Where constraints do not allow full-width walkways and bikeways, solutions should be sought to accommodate both modes (e.g., narrowing travel lanes or reducing on-street parking). In some urban situations, preference may be given to accommodating pedestrians. Sidewalks should not be signed for bicycle use—the choice should be left to the users.

Extruded Curbs

Raised concrete curbs create an undesirable condition when used to separate the motor vehicle lane from a bike lane or paved shoulder: Either one may hit the curb and lose control, with the motor vehicle crossing onto the bikeway or the bicyclist falling onto the roadway.

At night, the curbs cast shadows on the lane, reducing the bicyclist's visibility of the surface. Extruded curbs make bikeways difficult to maintain and tend to collect debris. They are often hit by motor vehicles, causing them to break up and scatter loose pieces onto the roadway surface.

Reflectors and Raised Pavement Markers

The placement of some raised pavement markers or reflectors can deflect a bicycle wheel, causing the bicyclist to lose control. If pavement markers are needed for motorists, they should be installed on the motorist's side of the lane stripe, and they should have a beveled front edge.

14.9 Student Exercise

Choose a local street that would be a good candidate for a bicycle boulevard. The street segment should be several blocks in length, and should include at least one crossing of a major arterial. Prepare a

conceptual design plan for the street segment, showing the location of signing, traffic signals, on-street parking, and traffic calming features. Your design should be shown in plan view, and should be accompanied by a narrative explaining the purpose of special design features.

14.10 References and Additional Resources

The references for this lesson are:

1. *Oregon Bicycle and Pedestrian Plan*, Oregon Department of Transportation, 1995.
2. *Guide for the Development of Bicycle Facilities*, AASHTO, Washington, DC, 1999.
3. *A Policy on Geometric Design of Highways and Streets*, AASHTO, Washington, DC, 2004.
4. *Roadway Shoulder Rumble Strips*, Technical Advisory T 5040.35, FHWA, available online at <http://www.fhwa.dot.gov/legsregs/directives/techadv/t504035.htm>, accessed April 27, 2004.
5. Outcalt, W., *Bicycle-Friendly Rumble Strips*, Colorado Department of Transportation, Publication No. CDOT-DTD-R-2001-4, May 2001, available online at <http://www.dot.state.co.us/publications/Bicycle%20Friendly/BFRSW.pdf>, accessed April 27, 2004.
6. Elefteriadou, L., M. El-Gindy, D. Torbic, P. Garvey, A. Homan, Z. Jiang, B. Pecheux, and R. Tallon, *Bicycle-Tolerable Shoulder Rumble Strips*, Pennsylvania Department of Transportation, March 2000, available online at <http://www.pti.psu.edu/mautc/docs/MA-III-0008.pdf>, accessed April 27, 2004.

Additional resources for this lesson include:

- MUTCD, FHWA, revised edition, November 2003, Washington, D.C., available online at <http://mutcd.fhwa.dot.gov/HTM/2003/html-index.htm>, accessed February 25, 2004.

LESSON 15:

BICYCLE LANES

15.1 Introduction

The 1999 AASHTO publication, *Guide for the Development of Bicycle Facilities* (hereafter referred to as the AASHTO *Guide*), defines a bicycle or bike lane as “a portion of a roadway which has been designated by striping, signing, and pavement markings for the preferential or exclusive use of bicyclists.”⁽¹⁾ The public agency and community support for bike lanes as a reasonable accommodation of bicyclists has been growing in many American cities. Although some cities such as Davis, CA, have several decades of experience, many American cities are still developing innovative ways to design bike lanes into complex roadway and traffic environments. A number of best design practices have emerged and are included in the 1999 AASHTO MUTCD.⁽²⁾ This lesson includes the design standards from AASHTO as well as additional design guidelines that other cities or States have developed. This lesson also summarizes other innovative bike lane designs and concepts (some are borrowed from Europe—see lesson 23) that are still being tested and evaluated.

The major sections of this lesson are as follows:

- 15.1 Introduction.
- 15.2 Width Standards and Cross-Section Design.
- 15.3 Retrofitting Bicycle Lanes on Existing Streets.
- 15.4 Bicycle Lanes at Intersections and Interchanges.
- 15.5 Bicycle Lane Pavement Markings.
- 15.6 Bicycle Lane Signing.
- 15.7 Other Design Considerations.
- 15.8 Practices to Avoid.
- 15.9 Student Exercise.
- 15.10 References and Additional Resources.

This lesson on bicycle lanes has been derived from several sources, including the 1999 AASHTO *Guide*, the 1995 *Oregon Bicycle and Pedestrian Plan*, and the *Philadelphia Bicycle Facility Design Guidelines*.^(1,3,4)

15.2 Width Standards and Cross-Section Design

Bicycle lanes serve the needs of all types of cyclists in urban and suburban areas by providing them with a dedicated travel lane within the street space. The minimum width of a bike lane will vary based on the roadway cross section (see figure 15-1). For roadways with no curb and gutter, the minimum width of a bike lane should be 1.2 m (4 ft). If parking is permitted, the bike lane should be placed between the parking area and the travel lane, and have a minimum width of 1.5 m (5 ft). Where parking is permitted but a parking stripe or stalls are not utilized, the shared area should be a minimum of 3.3 m (11 ft) without a curb face and 3.5 m (12 ft) adjacent to a curb.

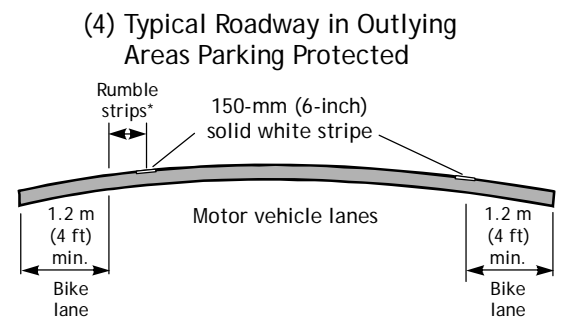
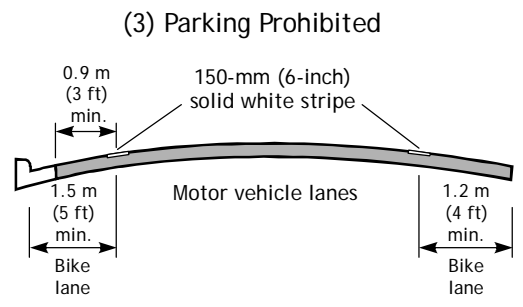
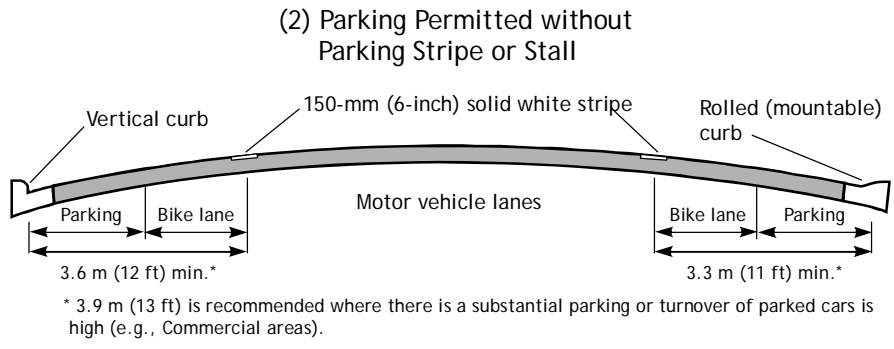
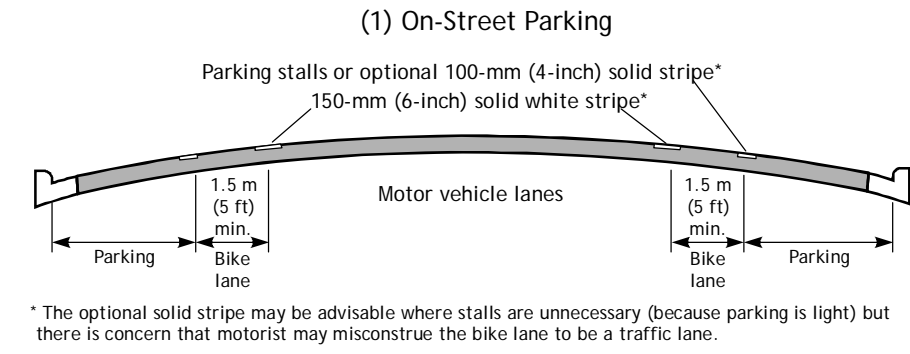

Figure 15-1. Illustrations. Typical bike lane cross sections.

Source: American Association of State Highway and Transportation Officials⁽¹⁾

The recommended width of a bike lane is 1.5 m (5 ft) from the face of a curb or guardrail to the bike lane stripe. This 1.5-m (5-ft) width should be sufficient in cases where a 0.3–0.6 m (1–2 ft) gutter pan exists, given that a minimum of 0.9 m (3 ft) of rideable surface is provided and the longitudinal joint between the gutter pan and the pavement surface is smooth. If the joint is not smooth, 1.2 m (4 ft) of rideable surface should be provided.

Since bicyclists usually tend to ride a distance of 0.8–1.0 m (32–40 in) from the curb face, it is very important that the pavement surface in this zone be smooth and free of structures. Drain inlets and utility covers that extend into this area cause bicyclists to swerve, resulting in a reduction of usable lane width. Where these structures exist and the surface cannot be made smooth, the bike lane width should be adjusted accordingly. Regular maintenance is critical for bike lanes (see lesson 16).

Bicycle lanes are always located on both sides of the road on two-way streets. Since bicyclists must periodically merge with motor vehicle traffic, bike lanes should not be separated from other motor vehicle lanes by curbs, parking lanes, or other obstructions. Two-way bike lanes on one side of two-way streets create hazardous conditions for bicyclists and are not recommended. The problems associated with two-way bike lanes are discussed in more detail in section 15.8.

On one-way streets, bicycle lanes should be installed on the right-hand side, unless conflicts can be greatly reduced by installing the lane on the left-hand side. Left-side bicycle lanes on one-way streets may also be considered where there are frequent bus or trolley stops, unusually high numbers of right-turning motor vehicles, or if there is a significant number of left-turning bicyclists.

15.3 Retrofitting Bicycle Lanes on Existing Streets

While bike lanes may be desirable in many urban locations, designers face the reality that space is limited on most urban streets. Unless plans call for a roadway widening project, the extra width for bike lanes is often very difficult to find in retrofit situations. In central business districts, roadway widening for bike lanes is usually not a desired option, since it could cause problems for pedestrians by further reducing sidewalk space. This section discusses possible options to consider when retrofitting bicycle lanes into limited space on existing streets.

Where existing street width does not permit desirable roadway cross-section dimensions to be used, it may be possible to modify elements of the roadway to accommodate bike lanes. In their guidelines, the Oregon Department of Transportation (ODOT) considers these options:⁽³⁾

- Reduction of travel lane width.
- Reduction of the number of travel lanes.
- Removal, narrowing, or reconfiguration of parking.
- Other design options.

ODOT uses the guidelines in this section to determine how a roadway can be modified to accommodate bike lanes without significantly affecting the safety or operation of the roadway. The reduced travel lane widths are within AASHTO minimums. ODOT stresses the importance of using good engineering judgment when retrofitting bike lanes on existing streets.

Reduction of Travel Lane Widths

The need for full-width travel lanes decreases with speed (see figure 15-2):

- Up to 40 km/h (25 mi/h), travel lanes may be reduced to 3.0 or 3.2 m (10.0 or 10.5 ft).
- From 50 to 65 km/h (30 to 40 mi/h), 3.3-m (11-ft) travel lanes and 3.6-m (12-ft) center turn lanes may be acceptable.
- At 70 km/h (45 mi/h) or greater, try to maintain a 3.6-m (12-ft) outside travel lane and 4.2-m (14-ft) center turn lane if there are high truck volumes.

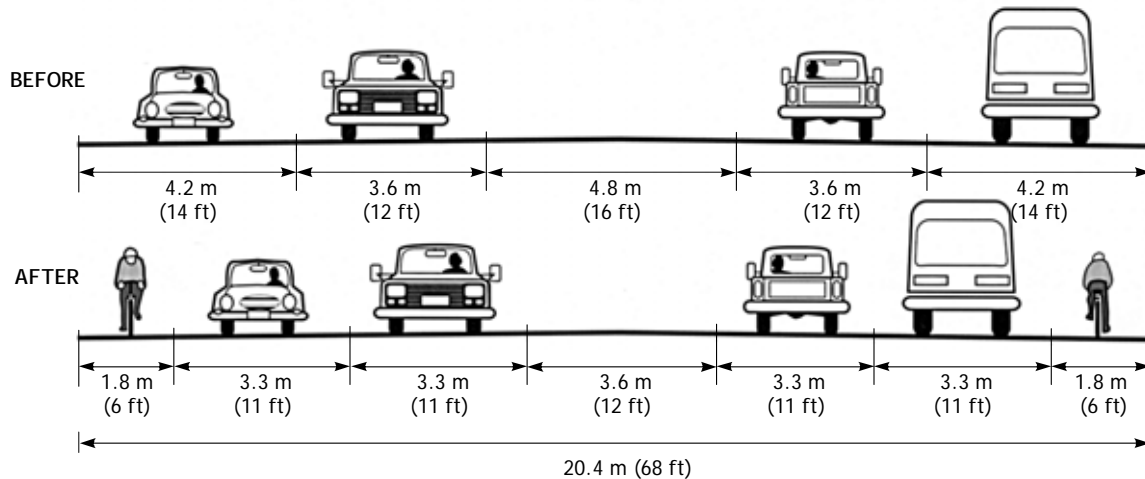

Figure 15-2. Illustration. Retrofitting bike lanes by reducing travel lane widths.

Source: Oregon Bicycle and Pedestrian Plan⁽³⁾

Reduction of the Number of Travel Lanes

Many one-way street pairs were originally two-way streets. This can result in an excessive number of travel lanes in one direction. A traffic capacity study will determine if traffic can be handled with one less lane (see figure 15-3).

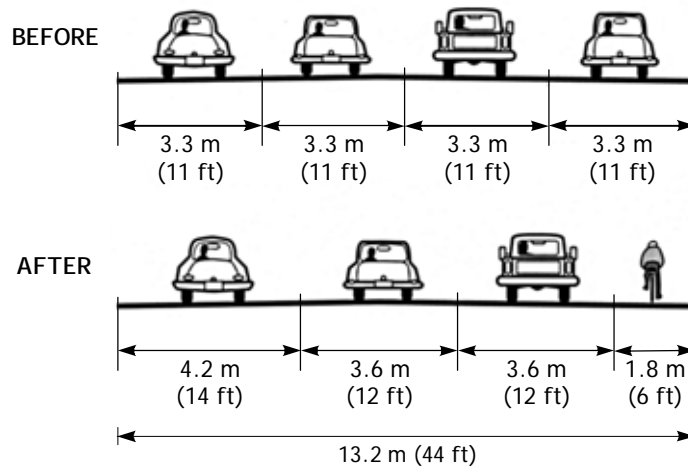

Figure 15-3. Illustration. Reducing the number of travel lanes on a one-way street.

Source: Oregon Bicycle and Pedestrian Plan⁽³⁾

On two-way streets with four travel lanes and a significant number of left-turn movements, restriping for a center turn lane, two travel lanes, and two bike lanes can often improve traffic flow (see figure 15-4). This type of street reconfiguration is referred to as a road diet and is considered to be effective at calming traffic and providing space for bicyclists while still providing a reasonable vehicle LOS. Burden and Lagerway summarize the street and location criteria that can be used to identify potential candidates for road diets:⁽⁵⁾

- Moderate volumes (8,000–15,000 ADT).
- Roads with safety issues.
- Transit corridors.
- Popular or essential bicycle routes/links.
- Commercial reinvestment areas.
- Economic enterprise zones.
- Historic streets.
- Scenic roads.
- Entertainment districts.
- Main streets.

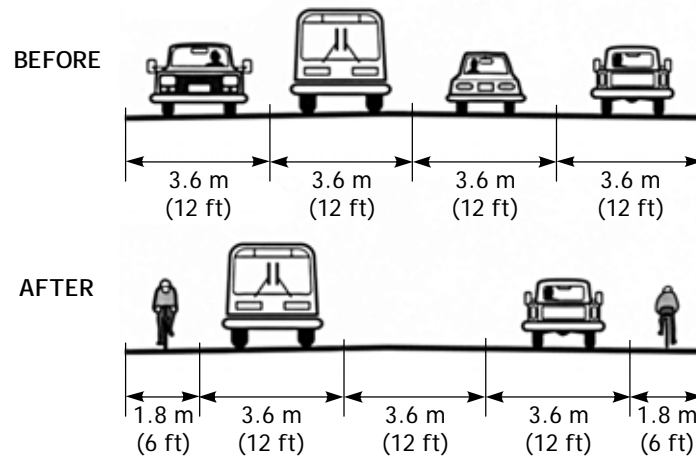

Figure 15-4. Illustration. Road diet: retrofitting bike lanes by reducing the number of travel lanes.

Source: Oregon Bicycle and Pedestrian Plan⁽³⁾

Removal, Narrowing or Reconfiguration of Parking

A roadway's primary function is to move people and goods rather than to store stationary vehicles. When parking is removed, safety and capacity are generally improved. Removal of parking will require negotiations with the local governing body (such as the city council), affected business owners, and residents. To reduce potential conflicts, careful research is needed before making a proposal, including:

- Counting the number of businesses and residences and the availability of both on-street and off-street parking.
- Selecting which side of the roadway would be less affected by removal (usually the side with fewer residences or businesses, or the side with residences rather than businesses in a mixed-use neighborhood).
- Proposing alternatives such as:
 - Allowing parking for church or school activities on adjacent lots during services or special events.
 - Promoting shared use by businesses.
 - Constructing special parking spaces for residents or businesses with no other options.

Instead of removal of all on-street parking, several other options can be pursued. Parking can be narrowed to 2.1 m (7 ft) (see figure 15-5), particularly in areas with low truck parking volumes.

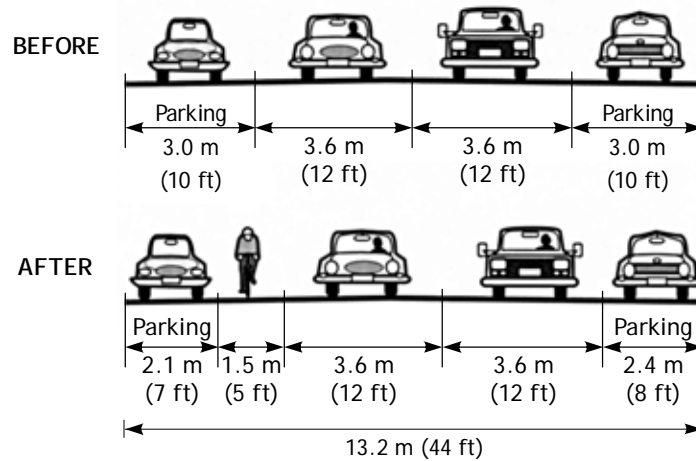

Figure 15-5. Illustration. Narrowing parking on a one-way street.

Source: Oregon Bicycle and Pedestrian Plan⁽³⁾

Bicycle lanes next to on-street parking can be problematic if enough space is not provided to prevent bicyclists from riding into an opened door. The AASHTO *Guide* recommends a combined width of 3.9 m (13 ft) for combined width of parking and bike lanes (see figure 15-1).

In some cases, parking may be needed on only one side to accommodate residences and/or businesses (see figure 15-6). Note that it is not always necessary to retain parking on the same side of the road through an entire corridor.

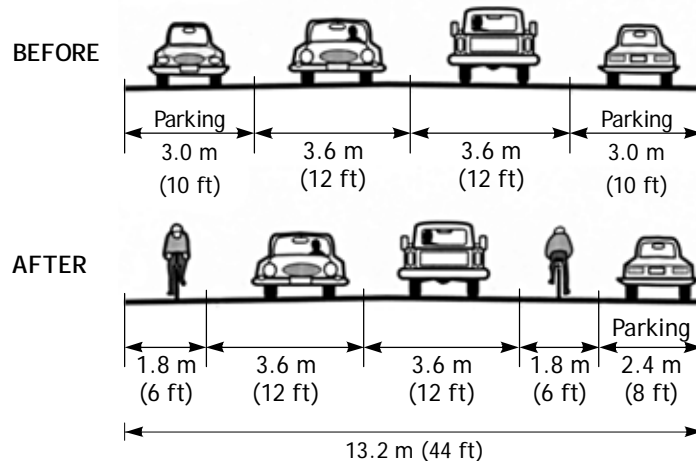

Figure 15-6. Illustration. Parking removed on one side of a two-way street.

Source: Oregon Bicycle and Pedestrian Plan⁽³⁾

Diagonal parking takes up an inordinate amount of roadway width relative to the number of parking spaces provided. It can also be hazardous, as drivers backing out cannot see oncoming traffic. Changing to parallel parking reduces availability by less than one-half (see figure 15-7). On one-way streets, changing to parallel parking on one side only is sufficient; this reduces parking by less than one-fourth.

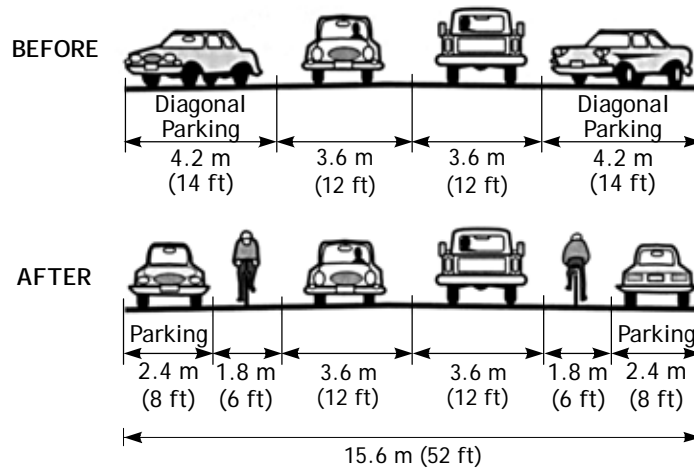

Figure 15-7. Illustration. Changing from diagonal to parallel parking on a two-way street.

Source: Oregon Bicycle and Pedestrian Plan⁽³⁾

Most business owners cite the fear of losing potential customers as the main reason to retain on-street parking. Many cities have had success with ordinances prohibiting employees from parking on the street. This could help increase the number of available parking spaces for customers, even if the total number of parking spaces is reduced. Note that one parking place occupied by an employee for 8 hours is the equivalent of 16 customers parking for half an hour, or 32 customers parking for 15 minutes.

Where all of the above possibilities of replacing parking with bike lanes have been pursued, and residential or business parking losses cannot be sustained, innovative ideas should be considered to provide parking, such as off-street parking. Other uses of the right-of-way should also be considered, such as using a portion of a planting strip where available (see figure 15-8).

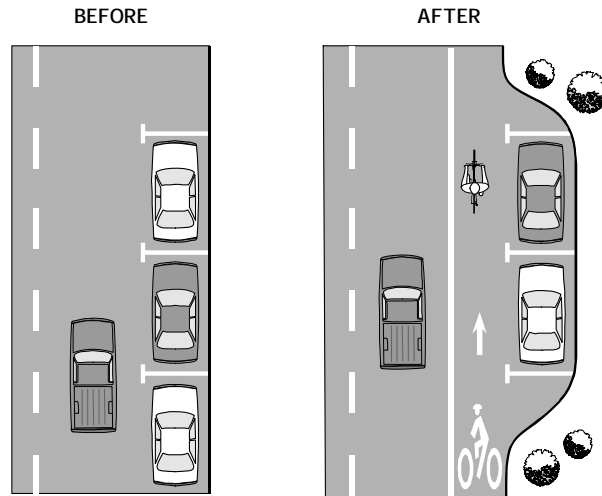

Figure 15-8. Illustration. Providing parking when there are no reasonable alternatives.

Source: Oregon Bicycle and Pedestrian Plan⁽³⁾

Other Design Options

Not all existing roadway conditions will be as simple to retrofit as those listed previously. In many instances, unique and creative solutions will have to be found. Width restrictions may only permit a wide curb lane (4.2–4.8 m (14–16 ft)) to accommodate bicycles and motor vehicles (see figure 15-9). Bike lanes must resume where the restriction ends. It is important that every effort be made to ensure bike lane continuity. Practices such as directing bicyclists onto sidewalks or other streets for short distances should be avoided, as they may introduce unsafe conditions.

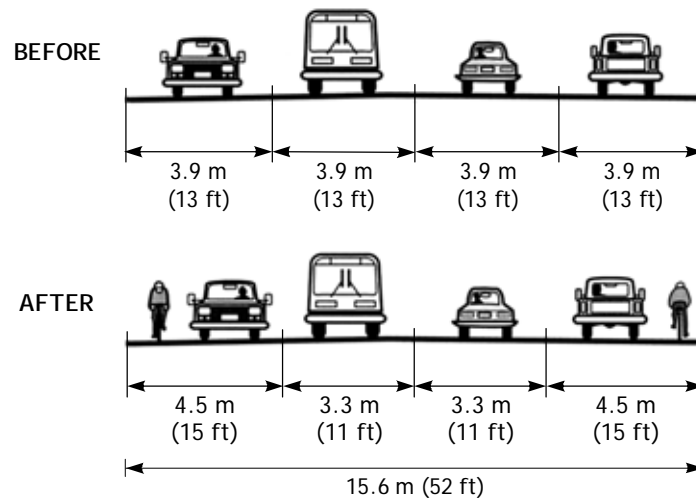

Figure 15-9. Illustration. Restriping for a wide curb lane.

Source: Oregon Bicycle and Pedestrian Plan⁽³⁾

Other minor improvements at the outer edge of the roadway should be made in conjunction with bike lane restriping, including:

- Existing drainage grates, and manhole and utility covers should be raised flush to the pavement prior to striping a bike lane.
- Minor widening may be required to obtain adequate width.
- Removal or relocation of obstructions away from the edge of the roadway may gain some usable width. Obstructions can include guardrails, utility poles, and sign posts.

Additional Benefits from Retrofitting Bike Lanes

Safety is enhanced as travel lanes are offset from curbs, lanes are better defined, and parking is removed or reduced. Adding bike lanes can often improve sight distance and increase turning radii at intersections and driveways. Restriping travel lanes redistributes motor vehicle traffic, which can help extend the pavement life, as traffic is no longer driving in the same well-worn ruts.

Salem, OR, Case Study

A paper by Chuck Fisher contains information about how the city of Salem, OR, approached the retrofit of bicycle lanes in their city.⁽⁶⁾ The first step in the retrofitting process was identifying which streets would make the best connections for bicyclists. In Salem, there is a lack of connectivity between the outer areas' bicycle facilities and the downtown core. Particularly lacking are connecting bicycle lanes within

3 km (2 mi) of downtown, the area most likely served by increased levels of bicycling. Salem city staff recognized that retrofitting these older neighborhoods with bike lanes and removing all on-street parking would probably have created a political firestorm. As a result, the staff developed policies and methodologies that allowed for the mitigation of on-street parking demand.

Policy Language. The relevant policy language is contained within the Goal, Objective, and Policies of the Salem Transportation System Plan's Bicycle System Element:

Policy 1.2—Mitigation of On-Street Parking Loss Due to Future Bicycle Facility

Projects. Where new bicycle facilities require the removal of on-street parking spaces on existing roadways, parking facilities shall be provided that mitigate, at a minimum, the existing on-street parking demand lost to the bike project. This policy does not apply to street widening or major reconstruction projects.

The key phrase in the policy is the mitigation of parking demand, not supply. As part of the update of the plan, the staff developed criteria for ranking potential bike projects. Working with this list, the staff determined which projects were to be included for the next construction season. First and foremost, the staff surveys the existing on-street parking demand on the facility. Other data collection includes existing cross sections and on-street parking supply. Analysis activities included sketching cross-section design, locating alternative on-street parking locations, and developing initial project cost estimates.

Public Involvement. At this point, the staff began a public involvement process that included neighborhood meetings, letters to abutting property owners, public workshops to determine alternatives, on-street sign notification, Citizens Advisory Traffic Commission meetings, and final approval by the City Council.

Some of the alternatives presented by the staff at the meeting workshops included restriping the road to accommodate parking on one side instead of two. Neighbors were asked to help determine on which side of the street parking should remain, given that only half of the parking supply would be required to meet the demand. A variation on this would be to alternate the parking from side to side. For instance, if a six-block area required parking on one side, a solution might be to allow parking on one side for three blocks and then changing to the other side for three blocks.

Another alternative would be to build parking bays, especially if only a small amount of parking mitigation would be required. Similar to bus bays or pull-outs, these would add the necessary room to accommodate parking in what had been the planting strip, between the curb and sidewalk.

15.4 Bicycle Lanes at Intersections and Interchanges

At intersections and interchanges, bicyclists proceeding straight through and motorists making turns must cross paths. Lane striping and signing configurations that encourage crossings and merging in advance of the intersection are preferable to those that force a crossing or merging in the immediate vicinity of the intersection. The following paragraphs within this section provide guidance on bike lane design issues at intersections and interchanges.

Intersections with Right-Turn Lanes

The AASHTO *Guide* provides supplemental information about the design of bike lanes at intersections with right-turn lanes.⁽¹⁾ Figure 15-10 illustrates typical bike lane design and pavement markings at a variety of intersection approaches. There are several possible approaches for bike lane design where these

right-turn lanes are present (see figure 15-11). The most desirable configuration will depend on the local road cross section and turning vehicle traffic patterns.

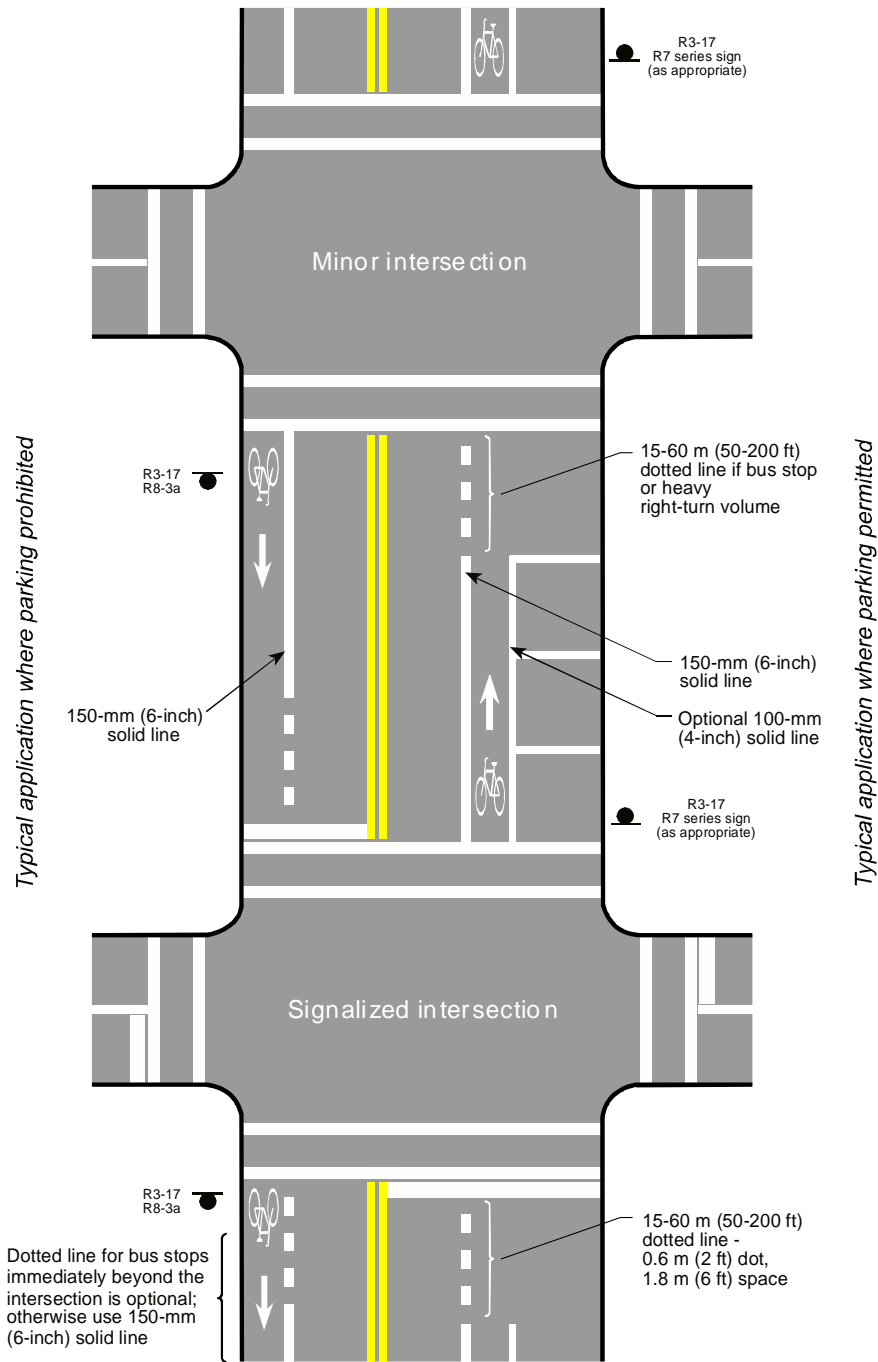
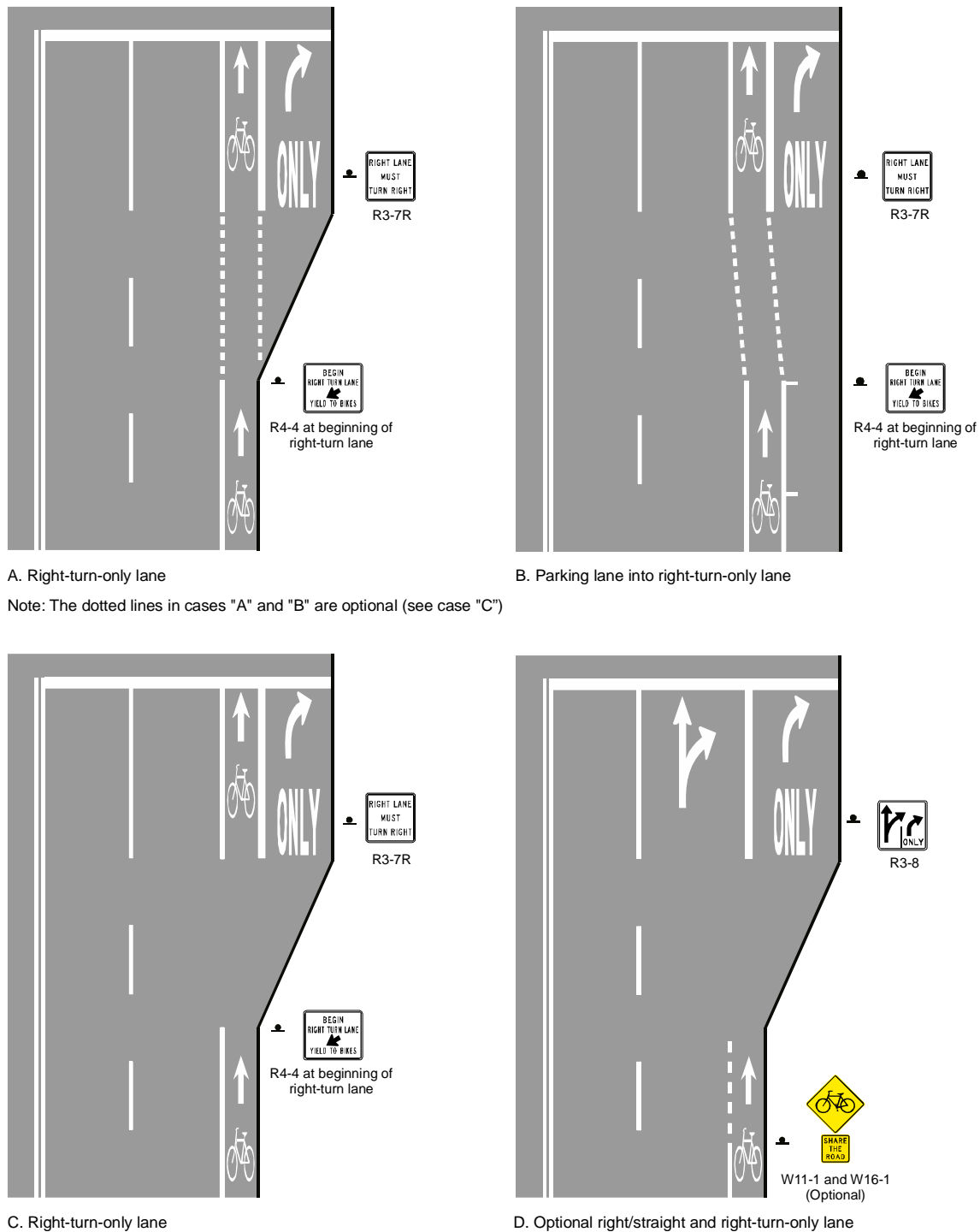

Figure 15-10. Illustration. Typical pavement markings for bike lane on two-way street.

Source: American Association of State Highway and Transportation Officials⁽¹⁾



Note: The dotted lines in cases "A" and "B" are optional (see case "C")

Figure 15-11. Illustrations. Possible configurations for bike lane and right-turn lane.

Source: American Association of State Highway and Transportation Officials⁽¹⁾

Dual right-turn lanes are particularly difficult for bicyclists. Warrants for dual turn lanes should be used to ensure that such lanes are provided only if absolutely necessary. The design for single right-turn lanes allows bicyclists and motorists to cross paths in a predictable manner, but the addition of a through lane

from which cars may also turn adds complexity. Some drivers make a last minute decision to turn right from the center lane without signaling, thus catching bicyclists and pedestrians unaware.

Several approaches to bike lane design with dual right-turn lanes are provided in figure 15-12. Design alternative A encourages cyclists to share the optional through-right-turn lane with motorists. Design alternative B guides cyclists up to the intersection in a dedicated bike lane. Design alternative C allows cyclists to choose a path themselves (this design is the AASHTO recommendation—simply dropping the bike lane prior to the intersection). Engineering judgment should be used to determine which design is most appropriate for the situation.

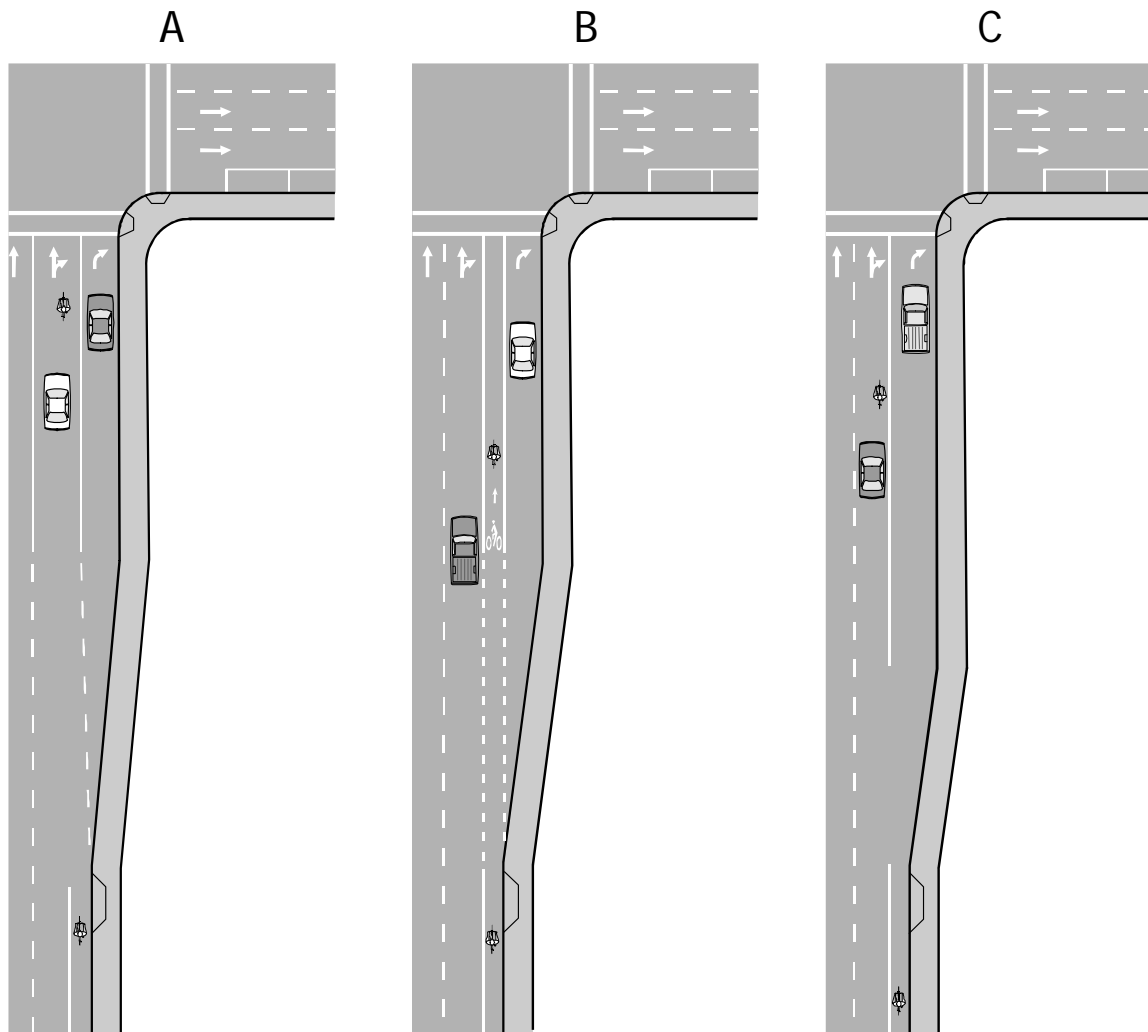

Figure 15-12. Illustrations. Design alternatives for a through bike lane with dual right-turn lanes.

Source: Oregon Bicycle and Pedestrian Plan⁽³⁾

On bike lane retrofit projects where there is insufficient room to mark a minimum 1.2-m (4-ft) bike lane to the left of the right-turn lane, a right-turn lane may be marked and signed as a shared-use lane to encourage through-cyclists to occupy the left portion of the turn lane (see figure 15-13). This has proven to be most effective on slow-speed streets.

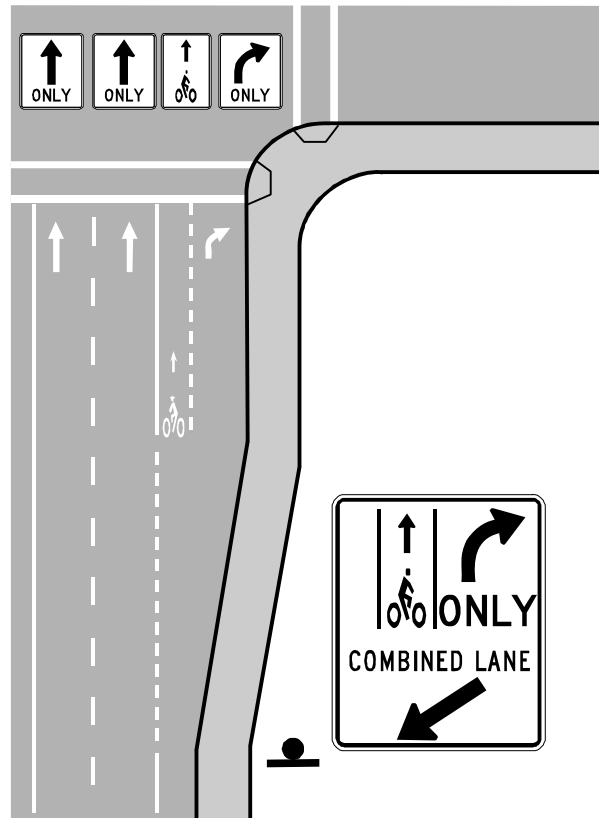

Figure 15-13. Illustration. Right-turn lane shared by bicyclists and motorists.

Source: Oregon Bicycle and Pedestrian Plan⁽³⁾

Intersections with Bus Stops

If there is a bus stop at the near side of an intersection, a broken white bike lane line between 15 and 60 m (50 and 200 ft) in length should be used, and the solid white line should resume on the far side of the intersection, immediately after the crosswalk (see figure 15-10). If a bus stop is located on the far side of the intersection, the solid white line on the far side of the intersection should be replaced with a broken line for a distance of at least 24 m (80 ft) from the crosswalk.

Traffic Signal Actuation

It is recommended that new on-road bicycle facilities include traffic signals that detect bicycles for all actuated signal systems. The *Traffic Detector Handbook* recommends several bicycle-sensitive loop configurations (loops are wires installed beneath the pavement surface that detect the presence of vehicles) that can effectively detect bicycles.⁽⁷⁾ The quadrupole loop is the preferred solution for bike lanes, and the diagonal quadrupole loop is preferred for use in shared lanes (see figure 15-14).

A potential solution for existing intersection signals that do not respond well to bicycles is to install a special pavement marking over the exact spot that a bicycle must stop in order to activate the signal. MUTCD, 2003 edition, recommends a pavement marking that can be used to locate these sensitive areas covering loop detectors for bicyclists (see figure 15-15).⁽²⁾

Quadrupole Loop

- detects most strongly in center
- sharp cut-off of sensitivity
- used in bike lanes

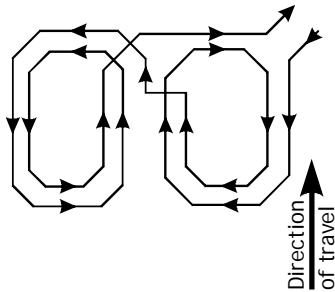

Diagonal Quadrupole Loop

- sensitive over whole area
- sharp cut-off of sensitivity
- used in shaded lanes

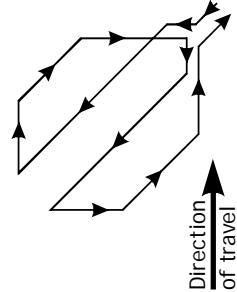

Standard Loop

- detects most strongly over wires
- gradual cut-off
- used for advanced detection

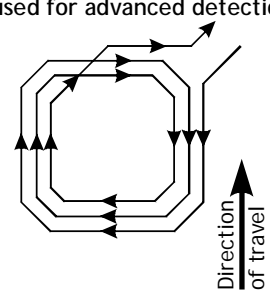

Figure 15-14. Illustrations. Different loop detector configurations for traffic signals.

Source: *Traffic Detector Handbook*⁽⁷⁾

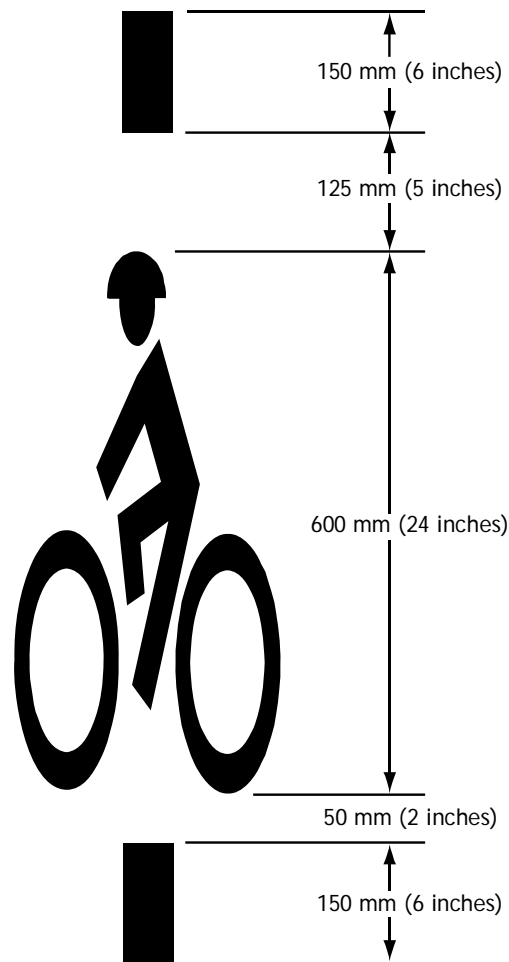

Figure 15-15. Illustration. Example of bicycle detector pavement marking.

Source: MUTCD, 2003 Edition⁽²⁾

Expressway Interchanges

Expressway interchanges often present barriers to bicycle travel. Designs that encourage free-flowing motor vehicle traffic movements are the most difficult for pedestrians and bicyclists to negotiate.

Interchanges with access ramps connected to local streets at a right angle are easiest for bicyclists to negotiate. The intersection of the ramp and the street should follow established urban intersection designs. The main advantages of this approach are:

- The distance that pedestrians and bicyclists must cross at the ramps is minimized.
- Signalized intersections stop traffic.
- Visibility is enhanced.

If these configurations are unavoidable, mitigation measures should be sought. Special designs should be considered that allow pedestrians and bicyclists to cross ramps in locations with good visibility and where speeds are low.

Where it is not possible to accommodate pedestrians and bicyclists with at-grade crossings, grade separation should be considered. Grade-separated facilities are expensive; they add out-of-direction travel and will not be used if the added distance is too great. This can create problems if pedestrians and bicyclists ignore the facility and try to negotiate the interchange at grade with no sidewalks, bike lanes, or crosswalks.

In some instances, a separate path can be provided on only one side of the interchange, which leads to awkward crossing movements. Some bicyclists will be riding on a path facing traffic, creating difficulties when they must cross back to a bike lane or shoulder (clear and easy-to-follow directions must be given to guide bicyclists' movements if those movements are inconsistent with standard bicycle operation).

The following concepts have been presented by ODOT as examples of innovative solutions to bike lane design at freeway/expressway interchanges and intersections.⁽³⁾ Traffic entering or exiting a roadway at high speeds creates difficulties for slower-moving bicyclists.

It is difficult for bicyclists to traverse the undefined area created by right-lane merge movements, because:

- The acute angle of the approach creates visibility problems.
- Motor vehicles are often accelerating to merge into traffic.
- The speed differential between cyclists and motorists is high.

The design in figure 15-16 guides bicyclists at merging entrance ramps in a manner that provides:

- A short distance across the ramp at close to a right angle.
- Improved sight distances in an area where traffic speeds are slower than farther downstream.
- A crossing in an area where drivers' attention is not entirely focused on merging with traffic.

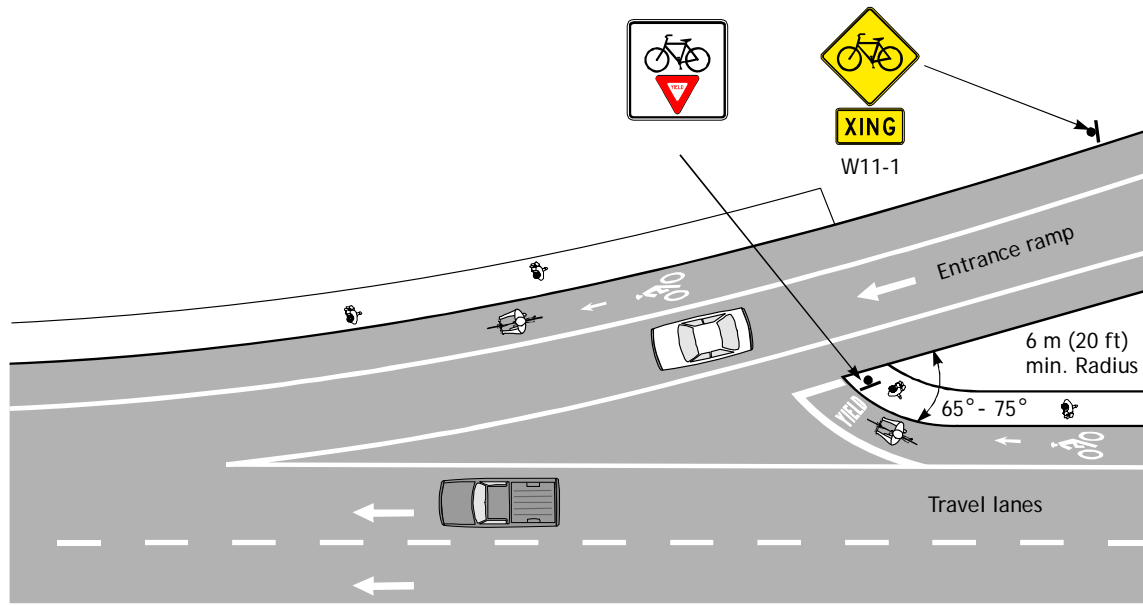

Figure 15-16. Illustration. Bike lane configuration at entrance ramp (urban design—not for limited access freeways).

Source: Oregon Bicycle and Pedestrian Plan⁽³⁾

Exit ramps present difficulties for bicyclists because:

- Motor vehicles exit at fairly high speeds.
- The acute angle creates visibility problems.
- Exiting drivers often do not use their right-turn signal, thus confusing pedestrians and bicyclists seeking a gap in the traffic.

The exit ramp design in figure 15-17 guides bicyclists in a manner that provides:

- A short distance across the ramp, at close to a right angle.
- Improved sight distances in an area where traffic speeds are slower than farther upstream.
- A crossing in an area where the driver's attention is not distracted by other motor vehicles.

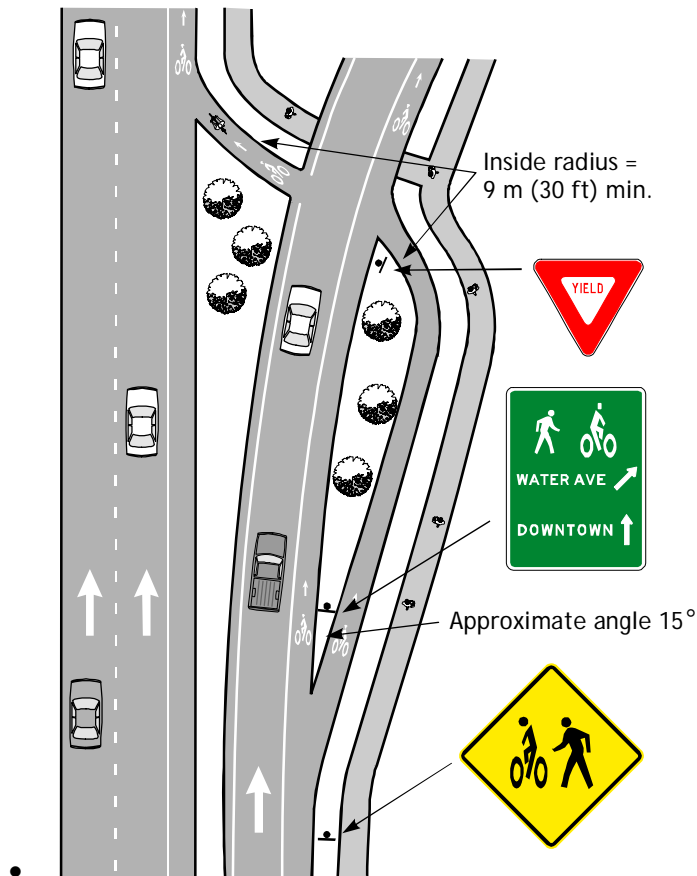

Figure 15-17. Illustration. Bike lane configuration at exit ramp (urban design—not for limited access freeways).

Source: Oregon Bicycle and Pedestrian Plan⁽³⁾

15.5 Bicycle Lane Pavement Markings

Section 9C of MUTCD addresses numerous aspects of pavement markings for bicycle facilities.⁽²⁾ Pavement markings typically consist of:

- Solid or broken-edge line lane markings that delineate the vehicle travel lane and the bike lane (see figure 15-10 for examples).
- Lane symbols that indicate the preferential nature of the bike lane and its direction (see figure 15-18 for examples).
- Traffic signal detector symbol to indicate preferred bicyclist stopping location at actuated signals (see figure 15-15 for example).
- Pavement markings to warn of road hazards or obstructions.

Care should be taken to use pavement striping that is durable, yet skid-resistant. Reflectors and raised markings in bike lanes can deflect a bicycle wheel, causing a bicyclist to lose control. If reflective pavement markers are needed for motorists, they should be installed on the motorist's side of the stripe and have a beveled front edge.

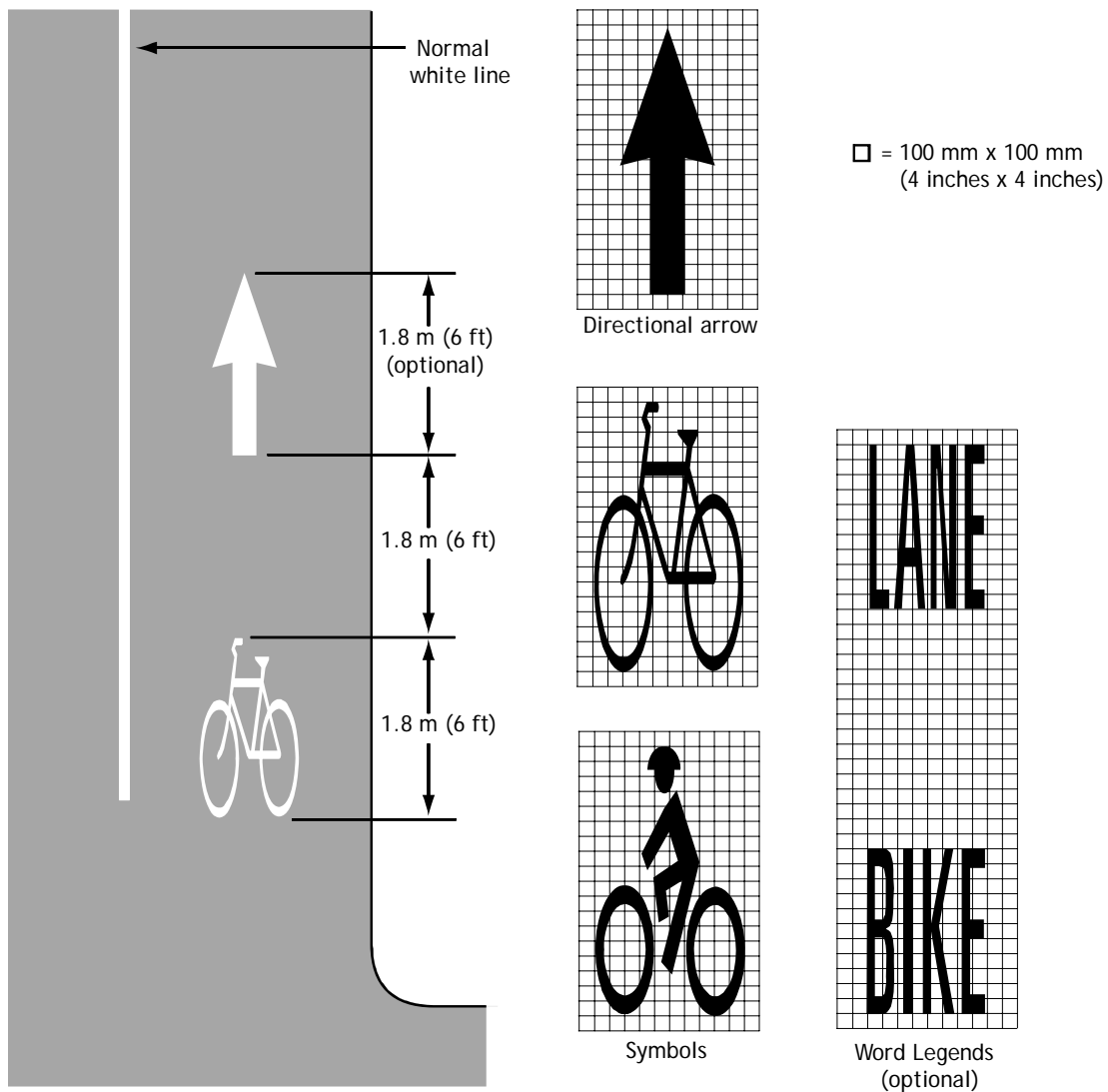

Figure 15-18. Illustrations. Examples of optional word and symbol pavement markings for bike lanes.

Source: MUTCD, 2003 Edition⁽²⁾

15.6 Bicycle Lane Signing

MUTCD section 9B addresses standard bike lane signing. Figure 15-19 shows regulatory signs for bicycle facilities (including bike lanes). MUTCD also provides recommendations for warning signs and bicycle route guide signs. Key MUTCD signing principles for bicycle facilities are:

- Bicycle signs shall follow standard MUTCD conventions for shape, legend, and color.
- All signs shall be retroreflectorized.
- Where signs serve bicyclists and other road users, the size, vertical mounting height, and lateral placement shall be as specified for vehicle traffic applications.

- Except for size, the design of signs specifically for bicycle facilities should be identical to that specified in MUTCD for vehicular travel.

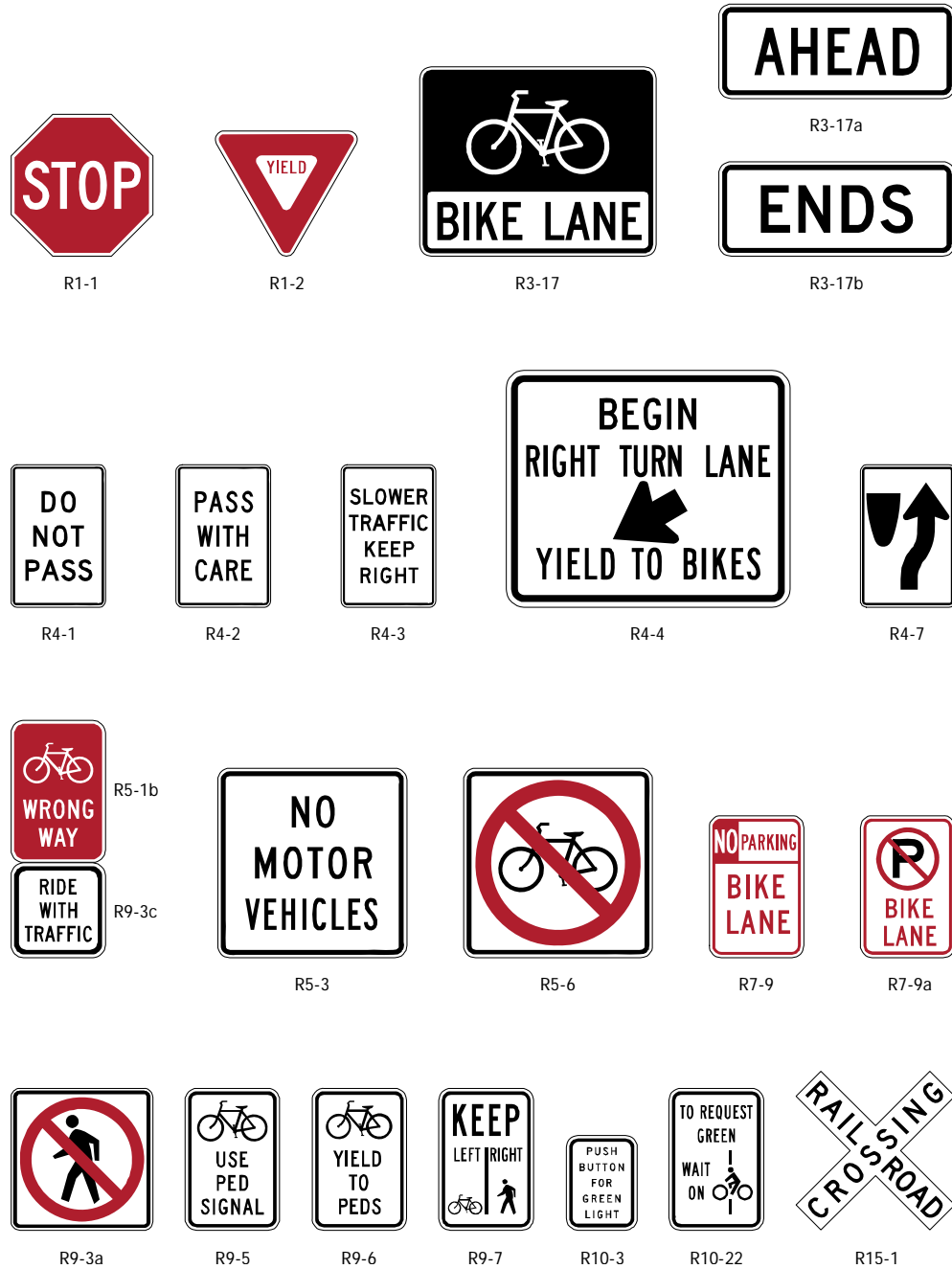

Figure 15-19. Illustrations. Regulatory signs for bicycle facilities.

Source: MUTCD, 2003 Edition⁽²⁾

15.7 Other Design Considerations

Colored Bike Lanes

Colored bike lanes have been tested in two U.S. cities (Portland, OR, and Cambridge, MA) as a way to guide bicyclists through complex intersections as well as to make motorists aware that they are crossing a bike lane. The concept of colored bike lanes has been applied and is standard practice in several European countries such as The Netherlands, Germany, Denmark, Sweden, Switzerland, Belgium, and France (see lesson 23). A study of blue bike lanes in Portland, OR (see figure 15-20 for example), reached the following conclusions:⁽⁸⁾

- Significantly more motorists yielded to bicyclists and slowed or stopped before entering the blue pavement area;
- More bicyclists followed the colored bike lane path.
- Fewer bicyclists turned their heads to scan for traffic or used hand signals, perhaps signifying an increased comfort level or lower level of caution.

Colored bike lanes have issues of maintenance—the paint wears quickly with vehicle traffic. As of 2004, the use of colored bike lanes has not been endorsed by any national design manuals or standards (such as the AASHTO *Guide* or MUTCD).



Figure 15-20. Photo. Example of blue bike lane in Portland, OR.

Source: *Evaluation of the Blue Bike-Lane Treatment Used in Bicycle/Motor Vehicle Conflict Areas in Portland, Oregon*, <http://www.trans.ci.portland.or.us/bicycles/broadwayblue.htm>⁽⁸⁾

Contraflow Bike Lanes

Contraflow bicycle lanes on a one-way street are not usually recommended. They may encourage cyclists to ride against traffic, which is contrary to the rules of the road and a leading cause of bicycle/motor vehicle crashes. There are, however, special circumstances when this design may be advantageous:

- A contraflow bike lane provides a substantial savings in out-of-direction travel.
- The contraflow bike lane provides direct access to high-use destinations.
- Improved safety because of reduced conflicts on the longer route.
- There are few intersecting driveways, alleys, or streets on the side of the contraflow lane.
- Bicyclists can safely and conveniently reenter the traffic stream at either end of the section.
- A substantial number of cyclists are already using the street.
- There is sufficient street width to accommodate a bike lane.

A contraflow bike lane may also be appropriate on a one-way residential street recently converted from a two-way street (especially where this change was made to calm traffic).

For a contraflow bike lane to function well, special features should be incorporated into the design:

- The contraflow bike lane must be placed on the proper side of the street (to motorists' left) and must be separated from oncoming traffic by a double yellow line. This indicates that the bicyclists are riding on the street legally, in a dedicated travel lane.
- Any intersecting alleys, major driveways, and streets must have signs indicating to motorists that they should expect two-way bicycle traffic.
- Existing traffic signals should be fitted with special signals for bicyclists (see figure 15-21); this can be achieved with either loop detectors or pushbuttons (these should be easily reached by bicyclists without having to dismount).

Under no circumstances should a contraflow bike lane be installed on a two-way street, even where the travel lanes are separated by a raised median.



*(This picture shows a bicyclist not wearing a helmet.
FHWA strongly recommends that all bicyclists wear helmets.)*

Figure 15-21. Photo. Contraflow bike lane with bicycle-specific signal in Madison, WI.

Diagonal Parking

Diagonal parking causes conflicts with bicycle travel: Drivers backing out have poor vision of oncoming cyclists; parked vehicles obscure other vehicles backing out. These factors require cyclists to ride close to the center of a travel lane, which is intimidating to inexperienced riders.

Where possible on one-way streets, diagonal parking should be limited to the left side, even if the street has no bike lane (on one-way streets with bike lanes, the bike lane should be placed adjacent to parallel parking, preferably on the right).

Bike lanes are not usually placed next to diagonal parking. However, should diagonal parking be required on a street planned for bike lanes, the following recommendations can help decrease potential conflicts:

- The parking bays must be long enough to accommodate most vehicles.
- A 200-mm (8-in) stripe should separate the parking area from the bike lane (see figure 15-22).
- Enforcement may be needed to cite or remove vehicles encroaching on the bike lane.

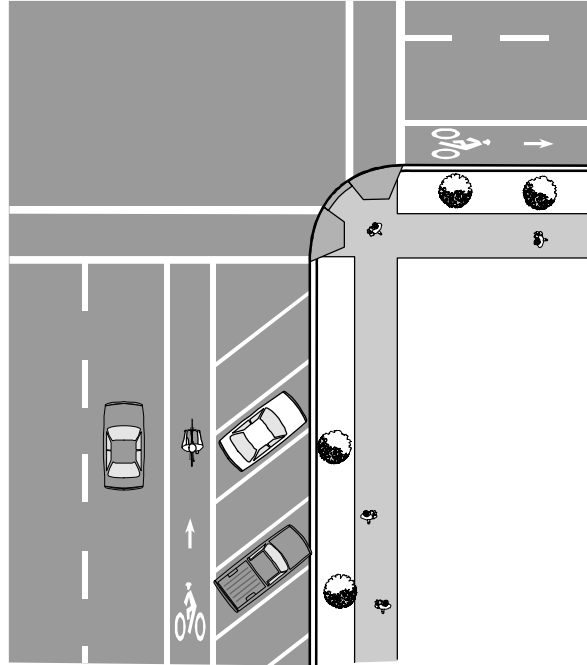

Figure 15-22. Illustration. Use of wide stripe to separate bike lane from diagonal parking.

Source: Oregon Bicycle and Pedestrian Plan⁽³⁾

Some cities have found the use of back-in diagonal parking to be more effective along streets with bike lanes. With back-in diagonal parking, parking motorists are required to stop in the travel lane and back their car across the bike lane into the parking spot. When leaving the back-in diagonal parking, the motorists are in a much better position to see bicycles approaching the bike lane. This design alternative has not been widely used yet, and more experience will determine its effects on the safety and operation of bike lanes near parking.

15.8 Practices to Avoid

Two-Way Bike Lanes

Two-way bike lanes create a dangerous condition for bicyclists (see figure 15-23). They encourage illegal riding against traffic, causing several problems:

- At intersections and driveways, wrong-way riders approach from a direction where they are not visible to motorists.
- Bicyclists closest to the motor vehicle lane have opposing motor vehicle traffic on one side and opposing bicycle traffic on the other.
- Bicyclists are put into awkward positions when transitioning back to standard bikeways.

If constraints allow widening on only one side of the road, the centerline stripe may be shifted to allow for adequate travel lanes and bike lanes.

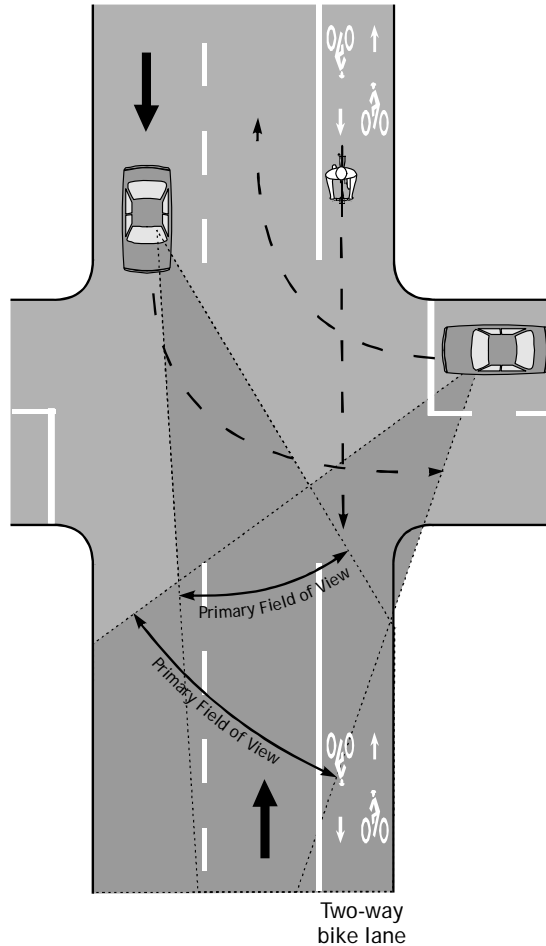

Figure 15-23. Illustration. A wrong-way bicyclist in a two-way bike lane is not in a driver's field of vision.

Source: Oregon Bicycle and Pedestrian Plan⁽³⁾

Continuous Right-Turn Lanes

A continuous right-turn lane configuration is difficult for bicyclists. Riding on the right puts them in conflict with right-turning cars, but riding on the left puts them in conflict with cars merging into and out of the right-turn lane. The best solution is to eliminate the continuous right-turn lane, consolidate accesses, and create well-defined intersections (Figure 15-24).

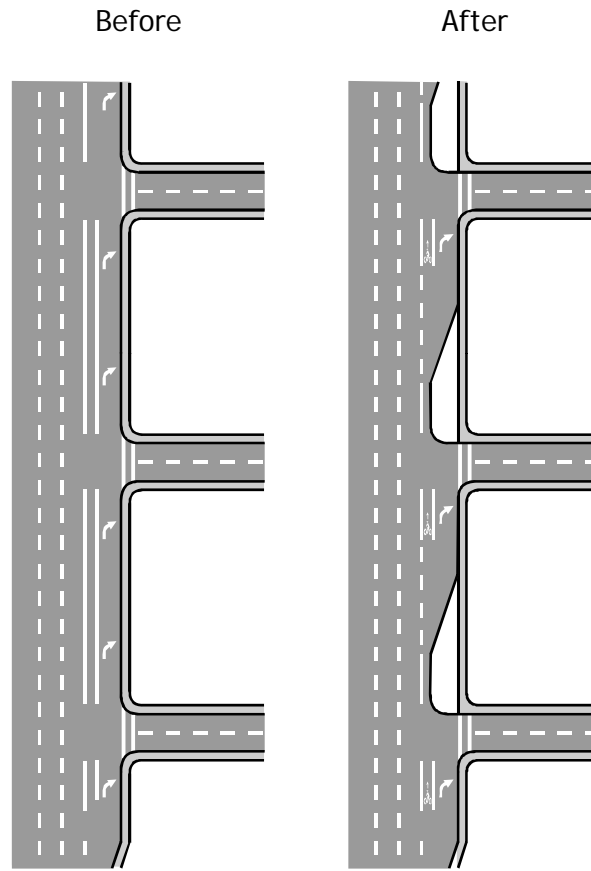

Figure 15-24. Illustration. Reconfiguration of a continuous right-turn lane to be bicycle-friendly.

Source: Oregon Bicycle and Pedestrian Plan⁽³⁾

15.9 Student Exercise

Exercise A

Redesign a local intersection to include bike lanes. Choose an intersection with a moderate level of complexity, and assume that curb lines can be moved at will in order to achieve your design. Prepare a report and graphics that show existing conditions and your recommended modifications. Signalization changes (if necessary) should also be explained, as well as any advance striping and signing needed on the intersection approaches.

Exercise B

Choose a local urban street that would be a good candidate for a bike lane retrofit project. Redesign a two-block section of the roadway to include bike lanes (sketch drawings will be sufficient). Present at least two options for retrofitting the street, and include solutions that would require further traffic studies. Indicate proposed dimensions for travel lanes, parking lanes, and bike lanes. If removal of parking is one of your solutions, describe the public involvement process you would go through to achieve agreement from adjacent property owners and businesses.

15.10 References and Additional Resources

The references for this lesson are:

1. *Guide for the Development of Bicycle Facilities*, AASHTO, Washington, DC, 1999.
2. MUTCD, FHWA, Washington, DC, 2003, available online at <http://mutcd.fhwa.dot.gov>, accessed April 22, 2004.
3. *Oregon Bicycle and Pedestrian Plan*, Oregon Department of Transportation, Salem, OR, 1995.
4. *Philadelphia Bicycle Facility Design Guidelines*, Philadelphia Department of Streets, Philadelphia, PA, 1998.
5. Burden, D., and P. Lagerwey, *Road Diets: Fixing the Big Roads*, Walkable Communities, Inc., March 1999, available online at <http://www.contextsensitivesolutions.org/content/reading/road-diets-3/resources/road-diets-fixing/>.
6. Fisher, C., "Retrofitting Bicycle Lanes While Mitigating On-Street Parking Demand," *Pro Bike/Pro Walk 1996 Conference Proceedings*, Portland, ME, September 1996.
7. Kell, J.H., I.J. Fullerton, and M.K. Mills, *Traffic Detector Handbook*, Publication No. FHWA-IP-90-002, FHWA, July 1990, available online at <http://www.fhwa.dot.gov/tfhrc/safety/pubs/Ip90002/intro.htm>, accessed April 28, 2004.
8. Hunter, W.W., D.L. Harkey, J.R. Stewart, and M.L. Birk, *Evaluation of the Blue Bike Lane Treatment Used in Bicycle/Motor Vehicle Conflict Areas in Portland, Oregon*, Publication No. FHWA-RD-00-150, August 2000, available online at <http://www.walkinginfo.org/pdf/r&d/bluelane.PDF>, accessed April 28, 2004.

Additional resources for this lesson include:

- *Bike Lane Design Guide*, PBIC, October 2002, available online at <http://www.bicyclinginfo.org/de/bikelaneguide.htm>, accessed April 28, 2004.

LESSON 16:

BICYCLE FACILITY MAINTENANCE

16.1 Introduction

This lesson describes maintenance programs and activities that are critical to successful bicycle facilities, and it recommends a step-by-step approach to solving common maintenance problems. The major sections of this lesson are as follows:

- 16.1 Introduction.
- 16.2 Problem Overview.
- 16.3 Solution Overview.
- 16.4 Objectives.
- 16.5 Implementation Strategies.
- 16.6 Subtasks.
- 16.7 Schedule and Resource Requirements.
- 16.8 Typical Maintenance Concerns.
- 16.9 Student Exercise.
- 16.10 References and Additional Resources.

This lesson on bicycle facility maintenance has been primarily derived from the “Bicycle-Related Maintenance” chapter of the FHWA publication, *Implementing Bicycle Improvements at the Local Level*.⁽¹⁾ Other sources of information are listed at the end of the lesson.

16.2 Problem Overview

Bicycles and bicyclists tend to be particularly sensitive to maintenance problems. Many bicycles lack suspension systems, and as a result, potholes that motorists would hardly notice can cause serious problems for bicyclists. In addition, since bicyclists often ride near the right edge of the road—sometimes as required by traffic law—they use areas that are generally less well maintained than the main traffic lanes. On roads with higher vehicle speeds, air from passing vehicle traffic typically sweeps debris to the right where most bicyclists travel. In addition, ridges, such as those found where a new asphalt overlay does not quite cover the older roadway surface, can catch a wheel, and throw a bicyclist to the ground.

Aside from these general problems, special bicycle facilities often need more maintenance than they receive. On shared-use trails, for example, vegetation is often allowed to overgrow the pavement edge, effectively narrowing the usable surface. Soil treatments that are commonly used under new roadbeds are sometimes ignored on trail projects; as a result, the surfaces are quickly destroyed by intruding plants.

16.3 Solution Overview

For the most part, satisfying bicycle facility maintenance requirements is a matter of slightly modifying current roadway procedures. For example, if street sweeping crews pay a bit more attention to the right edge of the road, it can benefit bicyclists greatly.

In addition, using maintenance-friendly design and construction techniques can reduce the need for special and sometimes costly treatments later. For example, when paving a street bordered by unpaved alleys and driveways, paving into those alleys and driveways 3 to 6 m (10 to 20 ft) (depending on grades and other features) can keep entering traffic from dragging gravel and other debris onto the paved surface.

Special bicycle facilities such as bike lanes or trails may require enhanced maintenance (see figure 16-1). This cost, along with a clear understanding of who has responsibility for maintenance, should be part of every project budget.



Figure 16-1. Photo. Shared-use paths and bicycle lanes may require additional maintenance.

16.4 Objectives

The primary objectives of a bicycle facility maintenance program should be to:

1. Maintain roadways and bikeways to a relatively hazard-free standard. This can be accomplished by:
 - Sweeping pavement edges and paved shoulders with sufficient care.
 - Patching surfaces as smoothly as possible and requiring other agencies or private companies to do likewise whenever they dig up a road or trail.
 - Making sure pavement overlay projects feather the new surface into the existing one or otherwise do not create new linear joints.
 - Replacing such hazards as dangerous grates or utility covers as the opportunity arises.
 - Patching potholes in an expeditious manner.
 - Routinely cutting back all encroaching vegetation, especially on trails or popular bike routes.
2. Encourage bicyclists to report maintenance problems and hazards. This can be accomplished by:
 - Developing a bicycle spot improvement form and distributing copies throughout the bicycling community.
 - Making sure returned forms are acted on in a timely fashion.

3. Design and build new roadways and bikeways in such a way as to reduce the potential for accumulating debris. This can be accomplished by:
 - Using edge treatments, shoulder surfaces, and access controls that reduce the potential for accumulation of debris (see figure 16-2).
 - Using materials and construction techniques that increase the longevity of new trail surfaces.



Figure 16-2. Photo. Roadways with paved shoulders should reduce on-road debris.

4. Include maintenance costs and clearly spelled-out maintenance procedures in all bicycle facility projects. This can be accomplished by:
 - Including reasonable estimates of the maintenance costs in the project budget.
 - Establishing clear maintenance responsibilities in advance of construction.

16.5 Implementation Strategies

Improving maintenance for bicycle facilities requires action on several fronts. First, maintenance policies used by all relevant agencies should be reviewed and changed, if necessary. Second, designers should be encouraged to think maintenance when they design: low-maintenance requirements should be the rule rather than the exception. And, finally, an outreach effort should be implemented to:

- Encourage bicyclists to report maintenance problems.
- Identify existing maintenance problems, particularly on special bicycle facilities or popular bicycling routes.

16.6 Subtasks

Subtask 1—Identify Key Implementers

Implementation requires working closely with those agencies and personnel responsible for maintaining the current infrastructure, as well as those charged with designing and building new facilities. For roadway maintenance, this may mean the local street department or the State transportation agency's district maintenance division. For trails, it may mean local, State, or Federal parks or lands agencies.

New facility design can involve local engineering and parks planning agencies, as well as State and Federal officials, depending on jurisdiction. It may be, for example, that a new arterial street being built in the local community is actually designed by engineers working in a remote headquarters office.

Subtask 2—Review Existing Policies and Practices

In some cases, an agency's policies, standards, and guidance are included in formal documents that have gone through an approval process or that have been issued by department supervisors. Examples of these may be standard sweeping schedules and priority streets for snow removal. Conducting a review of these may be relatively simple once copies have been obtained.

On the other hand, some practices may simply be matters of how a particular person handles a specific task. For instance, one street sweeper may leave more of the right roadway edge unswept than did another sweeper. Identifying important areas in which practices vary from standard procedure—or in which standard procedures do not exist—can help in determining needed improvements in such areas as policy development, communication, and employee training.

Subtask 3—Review Results in the Field and Solicit Comments from Users

In some cases, policies may seem reasonable in theory but may break down in practice. For this reason, it is important to see how well the facilities work. Checking out the street and trail system from the saddle of a bicycle can help uncover previously unknown problems. For instance, an agency may have a policy of sweeping arterial streets every two weeks. But field experience may show that certain arterials are subject to greater accumulations of debris from nearby land uses. Increasing the frequency of sweeping on such streets—particularly if they are popular bicycling streets—may be necessary.

In addition, soliciting comments from users can help identify problems that would otherwise be overlooked. Because of their intimate knowledge of surface conditions, bicycle users can often pinpoint specific locations and needs. To get information, send news releases to local bicycle groups, as well as the media, asking for help. In all likelihood, users will welcome the opportunity to contribute.

Subtask 4—Recommend Appropriate Changes in Policies and Practices

Based on the reviews and comments discussed above, develop modified versions of policies and practices where warranted; for important topics not previously covered, develop new guidance for adoption. Work with the appropriate agencies to make sure the changes are understood and implemented.

Subtask 5—Create an Ongoing Spot Improvement Program

As mentioned earlier, soliciting comments from users can help an agency find specific problem locations. Institutionalizing this process, in the form of a spot improvement program, can provide ongoing input and, in many cases, help identify problems before someone gets hurt. In addition, such a program can

dramatically improve the relationship between an agency and the bicycling public. Spot improvement programs are good policy and good public relations.

To this end, set aside a modest annual budgetary allocation for user-requested spot improvements. Create mail-back postcards (see figure 16-3 for example postcard) for distribution to local bicycle shops and user groups. As cards come in, check out the locations identified and take action as necessary.

TYPE:
 Safety Hazard Access Restriction Facility Need

LOCATION:
Street, landmarks

PROBLEM:
What is it and why is it a problem?

RECOMMENDATION:
What should be done about it?

Figure 16-3. Photo. Example of spot improvement postcard used to identify roadway maintenance issues.

Source: Vermont Bicycle & Pedestrian Coalition⁽²⁾

Subtask 6—Evaluate Progress

As the work proceeds, keep track of successes and failures, as well as the schedule of routine maintenance activities. Identify changes that have or have not been made to policies and determine if additional effort is needed. On an annual basis, ask the bicycling public for comments on maintenance issues in general, and the spot improvement program in particular. In addition, keep track of the numbers and kinds of problems identified and how they were dealt with. Finally, determine if the program budget is appropriate to the task.

16.7 Schedule and Resource Requirements

In regions with harsh winters, special effort should be made to clear the winter's accumulation of road sand and other debris early in the spring. Also, the periods following high winds and flooding may require special attention.

For the most part, bicycle-related maintenance tasks involve the work an agency already does; little additional effort will be required. It may simply mean adding popular bicycling routes to the priority sweeping route network, for example. In some instances, however, additional equipment may be needed.

For example, maintaining a particular trail may require purchasing special equipment—perhaps a small sweeper or a special attachment for a tractor.

16.8 Typical Maintenance Concerns

The following paragraphs list and describe bicyclists' most common maintenance concerns and some typical solutions.

Surface Problems

Potholes and other surface irregularities. Patch to a high standard, paying particular attention to problems near bicyclists' typical travel alignments. Require other agencies and companies to patch to a similarly high standard; if repairs fail within a year, require remedial action.

Debris (sand, gravel, glass, auto parts, etc.) near the right edge of the road. Sweep close to the right edge. If necessary, use vacuum trucks to remove material, especially if it accumulates adjacent to curbs. Pay particular attention to locations such as underpasses, where changes in lighting conditions can blind bicyclists to surface hazards.

Debris or surface irregularities on curves or at intersections. Pay special attention to the areas between the typical paths of turning and through motor vehicle traffic; often these fill with debris and are in typical bicyclist trajectories. In addition, areas where debris washes across the paved surface should receive special attention; for example, eliminating the source of the problem by providing better drainage is ultimately a more cost-effective solution than increased sweeping.

Chip seal gravel. Many local agencies use chip seal to extend the lives of their roadways. However, the technique, which involves laying down a coating of oil and a layer of crushed rock, often leaves deep piles of gravel just to the right of the typical travel paths of motor vehicles. To reduce the impact on bicyclists, remove excess gravel as soon as possible and suggest alternative routes as detours.

Ridges or cracks. These should be filled or ground down as needed to reduce the chance of a bicyclist catching a front wheel and crashing. Pay particular attention to ridges or cracks that run parallel to the direction of travel. One common location to check is where a merging lane is provided just beyond an intersection. Because traffic must merge left to continue traveling straight, the bicyclist will be crossing the joint between the merge lane and the through lane at a very shallow angle.

Snow removal. Many shared-use paths in colder climates will require snow removal during the winter. Snowplows and other snow removal equipment typically used for streets are often much too large to maneuver on shared-use paths. Special snow removal equipment and policies should be considered part of regular trail maintenance. Snow removal policies for shared-use paths should address the overall priority of this activity and estimated clearance times so that trail users can adjust their trips and expectations accordingly. In some cases, snow removal policies may also address whether snow is to be cleared. Along some trails and paths in northern climates, snow is left in place for the benefit of cross country skiing and other snow-related activities.

Encroaching Vegetation

Bushes and tree branches adjacent to trail edges. Trim vegetation back to allow at least a 0.6-m (2-ft) clearance between the edge of the pavement and the vegetation, paying particular attention to the insides of curves.

Grasses adjacent to trail edges. Tall grasses should be mowed regularly to expose any potential hazards that might otherwise be hidden from a cyclist's view. In addition, vegetation should be prevented from breaking up the edge of pavement and encroaching on the trail surface.

Signing and Marking

Trail signing. Because they are often unique, trail signs may be subjected to frequent theft or vandalism. Regular inspections should be conducted to ensure that signs are still in place and in good condition; this is particularly true of regulatory and warning signs.

Trail markings. Generally, trails have a few simple markings (e.g., a yellow center line); however, these should be repainted when necessary (see figure 16-4). Center lines, for example, perform the very useful function of encouraging bicyclists to keep to their side of the trail.

On-road bicycle signs. Special bicycle signs (regulatory, warning, or information) should be maintained in the same way that other roadway signs are. Pay particular attention to bike route signs at decision points, warning signs at special hazard locations, and regulatory signs on popular streets with bike lanes.

On-road bicycle markings. Bicycle lane striping should be renewed at the same time that other stripes are painted. The same goes for bike lane pavement markings. Some markings may suffer from more wear-and-tear than others and deserve special attention. For instance, pavement markings that indicate the hot spot for traffic signal loop detectors may be in a location where car tires routinely pass; as a result, they may wear out faster than other markings.



Figure 16-4. Photo. Example of newly striped bicycle lane with accumulation of debris next to curb.

Source: PBIC

Image Library, <http://www.pedbikeimages.org>⁽³⁾

16.9 Student Exercise

Inventory three to five bicycle facilities, rating their condition based on the techniques learned in the lesson (surface, vegetation, etc.—what are the problems and potential solutions?). Review policies and procedures to make improvements to the bicycle facility, documenting the ease of reporting and the remedy of any deficiencies reported.

16.10 References and Additional Resources

The references for this lesson are:

1. Williams, J., B. Burgess, and B. Wilkinson, *Implementing Bicycle Improvements at the Local Level*, USDOT, FHWA, Publication No. FHWA-RD-98-105, Washington, DC, September 1998.
2. Vermont Bicycle & Pedestrian Coalition, available online at <http://www.vtbikeped.org>, accessed May 17, 2004.
3. Image Library, PBIC, available online at <http://www.pedbikeimages.org>, accessed May 6, 2004.

Additional resources for this lesson include:

- *AASHTO Maintenance Manual: The Maintenance and Management of Roadways and Bridges, 3rd Edition*, AASHTO, Washington, DC, 1999.
- Flink, C.A., K. Olka, and R.M. Searns, *Trails for the Twenty-First Century: Planning, Design, and Management Manual for Multi-Use Trails*, Island Press, Washington, DC, 2000.
- *Guide for the Development of Bicycle Facilities*, AASHTO, Washington, DC, 1999.

LESSON 17:

BICYCLE PARKING AND STORAGE

17.1 Introduction

Bicycle parking is an important supporting element in bicycle programs. Quite simply, bicyclists need a safe and convenient place to park or store their bicycles along or at the end of most trips. This lesson contains the following information on developing an effective bicycle parking program: basic bicycle parking strategies; bicycle rack designs, specifications, and costs; and bicycle parking ordinances. The major sections of this lesson are as follows:

- 17.1 Introduction.
- 17.2 Overview of the Problem.
- 17.3 Overview of Bicycle Parking Strategies.
- 17.4 Implementing Bicycle Parking Strategies.
- 17.5 Student Exercise.
- 17.6 References and Additional Resources.

This lesson on bicycle parking and storage has been primarily derived from the “Bicycle Parking” chapter of *Implementing Bicycle Improvements at the Local Level*.⁽¹⁾ Other sources of information are listed at the end of the lesson.

17.2 Overview of the Problem

Providing secure bicycle parking is a key ingredient in efforts to encourage bicycling at the local level (see figure 17-1). Many bicycle trips end somewhere other than the bicyclist’s home, and as a result, the bicyclist must park his or her bicycle. And for those who live in apartment complexes, college dormitories, or other high-density settings, the issue of where to leave a bike while at home is also a serious issue. In short, at one time or another, most bicyclists have experienced the frustration of finding no secure place to leave their bikes.

While providing secure bicycle parking is not the entire solution to the problem of theft, it certainly can help, and it can increase bicyclists’ comfort in leaving their bicycles unattended. As a result, many bicycle owners may be encouraged to make bicycle trips that they might otherwise forego.



Figure 17-1. Photo. Effective bicycle parking improves security and reduces theft.

17.3 Overview of Bicycle Parking Strategies

An effective bicycle parking program should include the following basic strategies:

- **Provide bicycle parking in public rights-of-way.** Provide well-located secure bicycle parking at popular destinations in business districts and at other public sites:
 - Install bicycle parking at public centers.
 - Install bicycle parking on public rights-of-way in neighborhood commercial and downtown business districts.
 - Encourage private businesses to provide bicycle parking for their customers.
 - Install bicycle parking at transit stops and in parking garages.
 - Encourage the installation of high-security bicycle parking at existing worksites, schools, and high-density residential developments.
- **Provide bicycle parking in private development.** Encourage bicycle parking at existing developments and require new commercial, public, and high-density residential developments to include plans for bicycle parking:
 - Encourage existing businesses to provide bicycle parking for their customers.
 - Add provisions to local zoning regulations requiring bicycle parking as part of new developments, particularly commercial, public, and high-density residential developments.
 - Make these requirements part of the process of getting a building permit.

Typically, the provision of bicycle parking at public facilities helps to convince business owners of the need for bicycle parking on private development. The use of zoning regulations or bicycle parking ordinances helps in the long-term to ensure bicycle parking in newly developed areas.

Bicycle parking can be provided for these strategies using three types of devices (see figure 17-2):

1. **Bicycle racks.** These are open-air devices to which a bicycle is locked and work well for short-term parking.
2. **Bicycle lockers.** These are stand-alone enclosures designed to hold one bicycle per unit and are a good choice at sites that require long-term parking for a variety of potential users.
3. **Bicycle lock-ups.** These are site-built secure enclosures that hold one or more bicycles and are often used for long-term parking for a limited number of regular and trustworthy users.

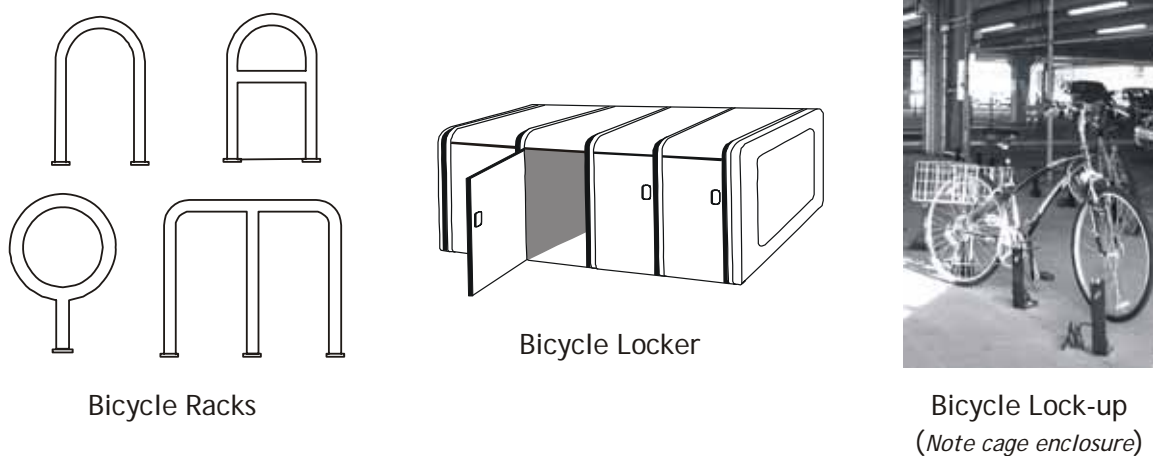

Figure 17-2. Illustrations and photo. Examples of common bicycle parking devices.

17.4 Implementing Bicycle Parking Strategies

This section describes one possible approach to implement bicycle parking. Other approaches are possible and encouraged, particularly if the bicycle parking program is managed by city or county government. This approach is organized chronologically by major steps.

Step 1—Identify Key Implementers

Each of the strategies described previously requires the cooperation of a different group of constituencies. Bicycle parking in public spaces requires the cooperation of public agencies who control or manage the property involved. Sidewalks are typically controlled by the streets or public works department, whereas a parks and recreation department typically has responsibility for open spaces and recreational areas. There may be an agency (similar to the Federal Government's General Services Administration) in charge of all public property. Or agencies that run specific services (e.g., libraries, public health clinics) may control their own sites.

Encouraging businesses to install bicycle parking may require the cooperation of such groups as the local chamber of commerce, downtown business association, or shopping center manager. In addition, agencies

that routinely deal with businesses should be enlisted as outlets for any literature developed as part of the program.

Altering zoning regulations to require consideration of bicycle parking in new developments requires close cooperation with city planning and zoning agency staff, as well as assistance from appointed zoning boards and builders' associations. Typically, regulations are revised on a schedule; therefore, the time or opportunity to revisit bicycle parking requirements will need to be coordinated with these schedules.

Step 2—Structure the Program

In some communities, a reactive program that simply fills orders and answers questions can be successful. This success would be most likely in a bicycle-friendly community with a high degree of interest in bicycling matters. However, in many places, a reactive approach will result in little and disorganized response. Business owners and managers of large employment centers or residential complexes often see bicycles as clutter and a problem to be eliminated rather than as a solution to traffic congestion or air quality problems. As a result, a successful bicycle parking program should include elements of marketing and promotion.

With the help of the key implementers identified in step 1, one could create three ad hoc task groups to cover three primary thrusts. The groups should create the ground rules and materials necessary for the following tasks:

- Task Group 1: Public Bicycle Parking.
 - Install bicycle parking at public centers.
 - Install bicycle parking on public rights-of-way.
 - Install bicycle parking at transit stops and in parking garages.
- Task Group 2: Private Bicycle Parking.
 - Encourage private businesses to provide bicycle parking for their customers.
 - Encourage installation of high-security bicycle parking at worksites, schools, and high-density residential developments.
- Task Group 3: Zoning Regulation Revision.
 - Add provisions to local zoning regulations requiring bicycle parking.
 - Make these requirements part of the process of getting a building permit.

Step 3—Identify Priority Locations that Need Bicycle Parking

The International Bicycle Fund (IBF) provides the following information on identifying locations for bicycle parking:⁽²⁾

Various mechanisms can be used for determining where bicycle parking is needed. Almost all the ones that are sited with bicyclist input are in heavy use. It is more likely that those sited for political consideration will be underutilized. Siting bicycle parking doesn't have to be scientific. Some of the best deterrents for bicycle parking are:

- **Visual observation:** Look for where bikes are parked illegally due to lack of legal parking. The (car) parking patrol people can probably do this for you in a week.

- **User input:** Ask bicyclists (through clubs or advocacy groups) to create a list of most-needed spots for bike parking.
- **Land use criteria:** Target every coffee shop, bookstore, video arcade, teen/young adult clothing store.
- **Public-private partnership:** Have a grant program whereby businesses can request bike parking for customers and employees, paying for the installation themselves, but getting the racks paid for by the grant.
- **Building code:** Require all new development or change of business to install bike parking proportionate to car parking requirements.

More scientific criteria may be useful for determining exactly what kind of bicycle parking device to install and exactly where.

- **Visibility:** Cyclists should easily spot short-term parking when they arrive from the street. A highly visible location discourages theft and vandalism. Avoid locations “off on the side,” “around the corner” or in un-supervised parking structures or garages.
- **Access:** The parking area should be convenient to building entrances and street access, but away from normal pedestrian and auto traffic. Avoid locations that require bicycles to travel over stairs.
- **Security:** Surveillance is essential to reduce theft and vandalism. For security, locate parking within view of passersby, retail activity, or office windows. Better yet: officially assign building security, a parking lot attendant or other personnel to watch for suspicious behavior.
- **Lighting:** Bicycle parking areas should be well lit for theft protection, personal security and accident prevention.
- **Weather protection:** Whenever possible, protect bicycle parking area from weather. An existing overhang or covered walkway is recommended. Alternatively, construct a canopy or roof—either freestanding or attached to an existing building.
- **Avoid conflict with pedestrians:** Locate racks so that parked bicycles don't block the pedestrian path. Select a bike rack with no protruding bars that could trip or injure cyclists or pedestrians. Very low bar-type racks can be a hazard to pedestrians and are not recommended.
- **Avoid conflict with automobiles:** Separate bicycle parking, auto parking, and road areas with space and a physical barrier. This prevents motor vehicles from damaging parked bicycles and keeps some thieves at a distance. Most professional bike thieves use vans or similar vehicles to hide their activities and make a getaway with their loot concealed. The closer bicycle parking is to automobile parking, alleys, roads, etc., the better the opportunity for a bike thief.

The following location criteria have been gathered from guidelines used by the cities of Denver and Seattle for placing bicycle racks:

- Racks should be located within 15.2 m (50 ft) of building entrances (where bicyclists would naturally transition into pedestrian mode).
- Racks should be installed in a public area within easy viewing distance from the main pedestrian walkway, usually on a wide sidewalk with 1.5 m (5 ft) or more of clear sidewalk space remaining

(a minimum of 61 cm (24 in) of clear space from the parallel wall and 76 cm (30 in) from the perpendicular wall).

- Racks are placed to avoid conflicts with pedestrians. They are usually installed near the curb and at a reasonable distance from building entrances and crosswalks.
- Racks can be installed at bus stops or loading zones only if they do not interfere with boarding or loading patterns and there are no alternative sites.

Step 4—Choose Appropriate Bicycle Parking Devices

As described earlier, bicycle parking can be accomplished with three basic devices: racks, lockers, or lock-ups (see figure 17-2). Packets of information should be assembled for available bicycle parking devices, along with the pros and cons of each device. In a joint meeting(s) with all three task groups, adopt a set of criteria and decide which devices are to be endorsed. Typical criteria used to evaluate bicycle parking devices are security (and how well the device works with common bicycle locks), durability and resistance to vandalism, ease of use, aesthetics, and cost.

The Association of Pedestrian and Bicycle Professionals (APBP) publication, *Bicycle Parking Guidelines*, suggest that bicycle racks should:⁽³⁾

- Support the bicycle upright by its frame in two places.
- Prevent the wheel of the bicycle from tipping over.
- Enable the frame and one or both wheels to be secured.
- Support bicycles without a diamond-shaped frame with a horizontal top tube (e.g., a women's or other frame).
- Allow front-in parking: a U-lock should be able to lock the front wheel and the down tube of an upright bicycle.
- Allow back-in parking: a U-lock should be able to lock the rear wheel and the seat tube of the bicycle.
- Resist being cut or detached using common hand tools.

AASHTO's *Bicycle Guidelines* recommend that bicycle racks should:⁽⁴⁾

- Not bend wheels or damage other bicycle parts.
- Accommodate high-security U-shaped bike locks.
- Accommodate locks securing the frame and both wheels (preferably without removing the front wheel from the bicycle).
- Not impede or interfere with pedestrian traffic.
- Be easily accessed from the street and protected from motor vehicles.
- Be visible to passersby to promote usage and enhance security.
- Be covered where users will leave their bikes for a long time.
- Have as few moving parts as possible.
- Accommodate a wide range of bicycle shapes and sizes.

- Be simple to operate.

Figure 17-3 illustrates a variety of bicycle racks that meet these requirements, whereas figure 17-4 illustrates types of bicycle racks that are not recommended because they fail to meet one or more of these requirements. The average cost for typical bicycle racks ranges from \$75 to \$100 per rack; a single rack typically holds one or two bicycles. The cost for bicycle lockers ranges considerably more, from about \$500 to \$1,500 per bicycle.

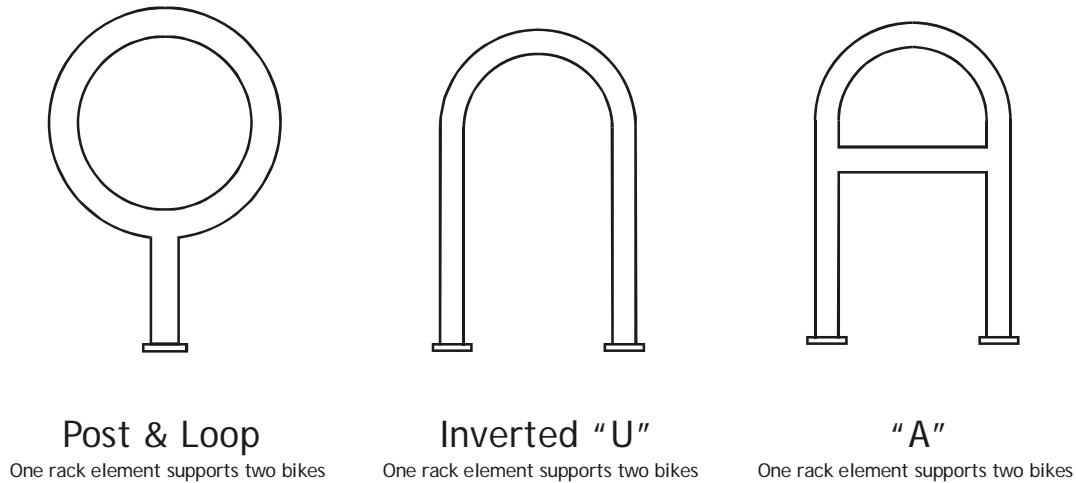
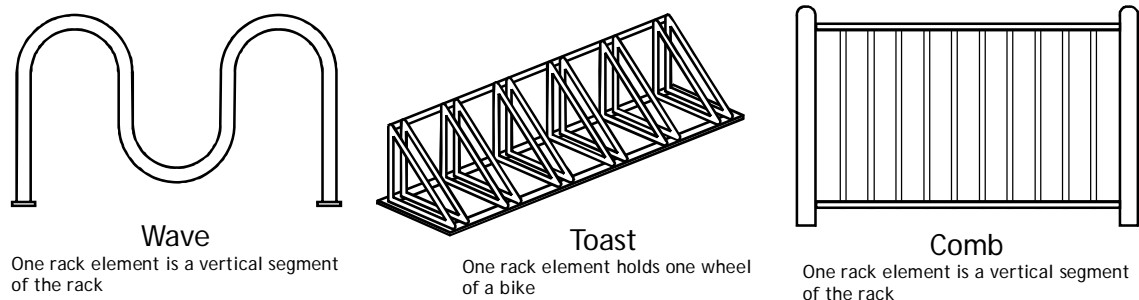

Figure 17-3. Illustrations. Recommended types of bicycle racks.

Source: *Bicycle Parking Guidelines*⁽³⁾



These bicycle racks are not recommended

Figure 17-4. Illustrations. Bicycle rack types that are not APBP-recommended.

Source: *Bicycle Parking Guidelines*⁽³⁾

In addition to the basic bicycle rack design, the layout of bicycle rack areas will need to be designed. The APBP *Bicycle Parking Guidelines* provides some minimum recommended dimensions for bicycle rack areas (see figure 17-5).⁽³⁾ Their guidelines also suggest that large rack areas with a high turnover rate have more than one entrance. If possible, the rack area should be protected from weather elements.

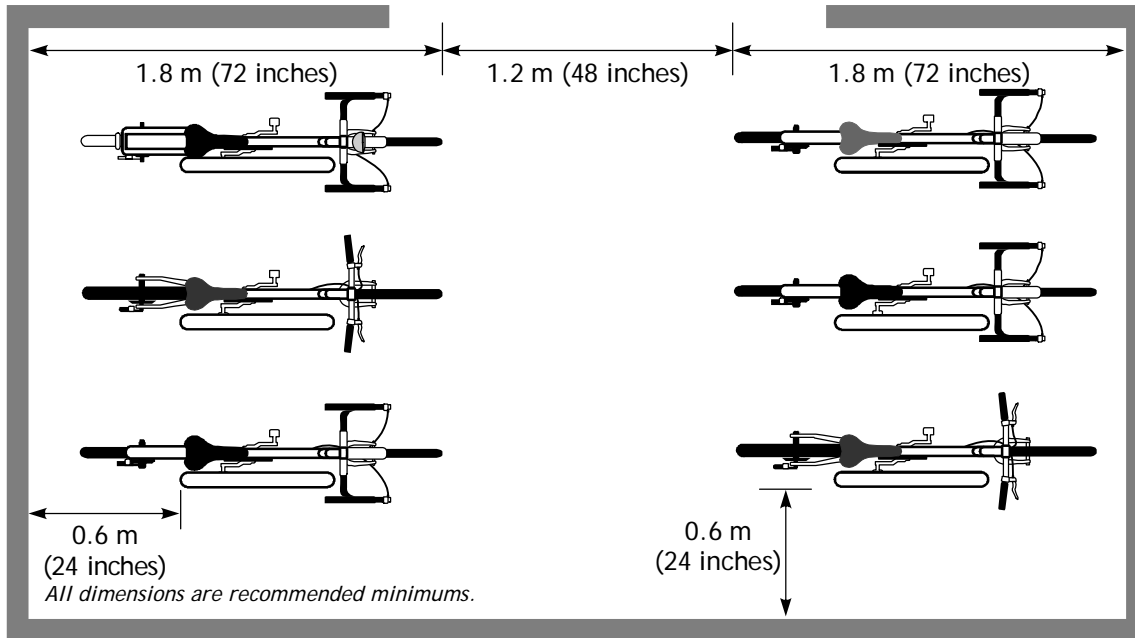

Figure 17-5. Illustration. APBP-recommended design dimensions for bicycle rack areas.

Source: *Bicycle Parking Guidelines*⁽³⁾

Step 5a—Tasks for Developing Public Bicycle Parking

The first task group should set criteria for installing bicycle parking on sidewalks as well as at public destinations. For sidewalks, criteria could include such items as minimum width of sidewalk, rack position on sidewalk and proximity to other street furniture and vegetation, and number per block or number per site. For public sites, they could include proximity to the main entrance, and minimum number of bicycle parking spaces per installation (i.e., based on the type of facility served).

Next, they should create a step-by-step procedure for planning and installation. This should include initial identification of the potential site, discussion with relevant agency personnel, determination of the specific site's needs (number of parking devices and location), cost analysis and budgeting, procurement, installation, and followup.

To support this activity, they should create a project sheet for rack installation that includes places for the source of the request (if any), signatures of any required agency personnel, a schematic diagram of the site, installation date, and any comments.

Next, they should estimate the total bicycle parking need for public places given a list of potential sites. Estimates can be conservative and based to some extent on existing bicycle traffic, as long as participants recognize that latent demand may be significant. For this reason, phased installation may be particularly appropriate.

For sidewalks, a base number of racks to be installed during a fiscal year (e.g., 100, 500, or 750) should be decided, along with a map showing priority areas. For instance, downtown might be a top-priority area, neighborhood commercial areas could be second, and strip development areas might be third.

Finally, the first task group should set an annual budget for the program and decide how the bicycle parking will be funded. Potential sources include a wide variety of Federal transportation programs, as well as local funding opportunities.

Step 5b—Tasks for Developing Private Bicycle Parking

The second task group should assemble a packet of information for potential private-sector bicycle parking providers. The packet should include a cover letter describing the importance of bicycle parking to businesses and giving any organizational endorsements for the program; a list of available parking devices, along with information on how to order them and which are best suited for which settings; tips on deciding how many bikes need to be accommodated; and tips on locating and installing the devices.

The second task group should also work out details of any promotional activities that will need to be planned. For instance, they should develop a list of groups to talk with, determine who should be responsible for reaching each one, and start making contacts. To this end, the task group should develop a standard presentation, possibly including slides and handouts.

Step 5c—Tasks for Revising Zoning Regulations

The third task group should start by identifying passages in the existing zoning codes where motor vehicle parking is discussed. They should find out when the regulations are going to be modified and use that in determining their schedule of work. They should then assemble sample bicycle parking laws from other communities. Based on the sample laws, they should create a draft revision to the regulations and circulate it for comment. Once comments have been received and considered, they should forward a final draft revision for action at the proper time.

Based upon examples from several locations (e.g., Ann Arbor, MI, Madison, WI, Denver, CO, and San Francisco, CA), bicycle parking ordinances should include these elements:

1. **Number of spaces required.** Bike parking ordinances should clearly indicate how many bicycle parking spaces are required, either as a function of the type of development (retail, office, residential, etc.) or as a standard percentage of the required off-street automobile parking. For example, the City of Denver requires that off-street automobile parking facilities of 20 spaces or more provide bicycle parking equal to 5 percent of the automobile parking space requirement.
2. **Type(s) of permitted racks.** Bicycle racks that support the bike by the wheel should not be permitted.
3. **Location of bicycle racks.** Bicycle racks should be located at least as close to the building entrance as to the nearest parking space (excluding accessible parking spaces).
4. **Other elements.** The requirements can also address lighting of bicycle racks, requirements to retrofit existing public buildings, and protection from weather.

A growing number of communities have included bicycle parking requirements in their development regulations. By so doing, they ensure that bicycle parking is included in the normal course of development. Figure 17-6 contains excerpts about bicycle parking from the off-street parking ordinance in Madison, WI.⁽⁵⁾ Figure 17-7 illustrates the City of Philadelphia's standard for bicycle rack placement in business districts.⁽⁶⁾ Bicycle parking ordinances from numerous other cities can be found by searching a particular city's website for their planning, development, or land use ordinances.

Step 6—Implement the Program

With the program established, materials prepared, and initial funding identified, implementation of the program can begin. Routine responsibilities for the various tasks should be taken care of by the agencies identified through the previous steps. Oversight of the program may require the attention of a project coordinator. This may be a task delegated to a member of the planning department or public works staff.

Step 7—Evaluate Progress

As the work is proceeding, keep track of successes and failures. Early on, get the word out to the bicycling public that: (1) the program exists and (2) they should submit comments and ideas for potential parking sites. Keep a record of how many parking devices have been installed, how many comments have been received, how many information packets have been sent out, what proportion of public places has adequate bicycle parking, how well the parking is working (i.e., whether the public likes it, whether it holds up well to vandalism), and how successful the zoning regulations appear to be (once they are adopted). Use this feedback to fine-tune the program and determine future levels of funding.

Excerpts from “28.11 OFF-STREET PARKING AND LOADING FACILITIES”

(1) Statement of Purpose

...

(d) Providing adequate and safe facilities for the storage of bicycles.

(2) General Regulations

(a) Scope of Regulations

...

4. Bicycle parking facilities shall be provided as required for all new structures and uses established as provided in Sec. 28.11(2)(a)1. or for changes in use as provided in Secs. 28.11(2)(a)2. and 3; however, bicycle parking facilities shall not be required until the effective date of this paragraph. Notwithstanding Secs. 28.08(1)(i), 28.09(1)(i), and 28.09(5)(a), bicycle parking facilities shall be provided in all districts including districts in the Central Area.

...

(3) Off-Street Parking Facilities

(a) Utilization

1. In the residence district, accessory off-street parking facilities provided for uses listed herein shall be solely for the parking of passenger automobiles (including passenger trucks) and bicycles of patrons, occupants, or employees. Such vehicles are limited in size to less than one (1) ton in capacity.

...

(e) Size ... Required bicycle parking spaces shall be at least 0.6 m by 1.8 m (2 ft by 6 ft). An access aisle of at least 1.5 m (5 ft) shall be provided in each bicycle parking facility. Such space shall have a vertical clearance of at least 1.8 m (6 ft).

...

(h) Design and Maintenance. ... 2. d. Bicycle Parking Facilities. Accessory off-street parking for bicycle parking shall include provision for secure storage of bicycles. Such facilities shall provide lockable enclosed lockers or racks or equivalent structures in or upon which the bicycle may be locked by the user. Structures that require a user-supplied locking device shall be designed to accommodate U-shaped locking devices. All lockers and racks must be securely anchored to the ground or the building structure to prevent the racks and lockers from being removed from the location. The surfacing of such facilities shall be designed and maintained to be mud and dust free.

...

(i) Location. ... 3. Bicycle parking facilities shall be located in a clearly designated safe and convenient location. The design and location of such facility shall be harmonious with the surrounding environment. The facility location shall be at least as convenient as the majority of automobile parking spaces provided.

...

(l) Schedule of Required Off-Street Parking Facilities. ... 1. Bicycle parking facility spaces shall be provided in adequate number as determined by the Zoning Administrator. In making the determination, the Zoning Administrator shall consider when appropriate, the number of dwelling units or lodging rooms, the number of students, the number of employees, and the number of automobile parking spaces in accordance with the following guidelines:

(continued on next page)

Figure 17-6. Photo. Excerpts from off-street parking ordinance in Madison, WI.

Source: *Code of Ordinances*⁽⁵⁾

(l) Schedule of Required Off-Street Parking Facilities — *Continued*

Off-Street Bicycle Parking Guidelines

Land Use	Bike Space
Dwellings/lodging rooms	1 per dwelling unit or 3 lodging rooms
Clubs/lodges	1 per lodging room plus 3% of person capacity
Fraternities/sororities	1 per 3 rooms
Hotels/lodging houses	1 per 20 employees
Galleries/museums/libraries	1 per 10 automobile spaces
Colleges/universities/junior high and high schools	1 per 4 employees plus 1 per 4 students
Nursery/elementary schools	1 per 10 employees plus students above second grade
Convalescent and nursing homes/institutions	1 per 20 employees
Hospitals	1 per 20 employees
Places of assembly, recreation, entertainment, and amusement	1 per 10 automobile spaces
Commercial/manufacturing	1 per 10 automobile spaces
Miscellaneous/other	To be determined by the Zoning Administrator based on the guidelines for the most similar use listed above

- (l) 1. a. In all cases where bicycle parking is required, no fewer than two spaces shall be required.
- b. After the first fifty (50) bicycle parking spaces are provided, additional bicycle parking spaces required are 0.5 (one-half) space per unit listed.
- c. Where the expected need for bicycle parking for a particular use is uncertain due to unknown or unusual operating characteristics of use, the Zoning Administrator may authorize that construction and provision of not more than 50 percent of the bicycle parking spaces be deferred. Land area required for provision of deferred bicycle parking spaces shall be maintained in reserve....

Figure 17-6. Photo. Excerpts from off-street parking ordinance in Madison, WI—*Continued*

Source: Madison, WI, *Code of Ordinances*⁽⁵⁾

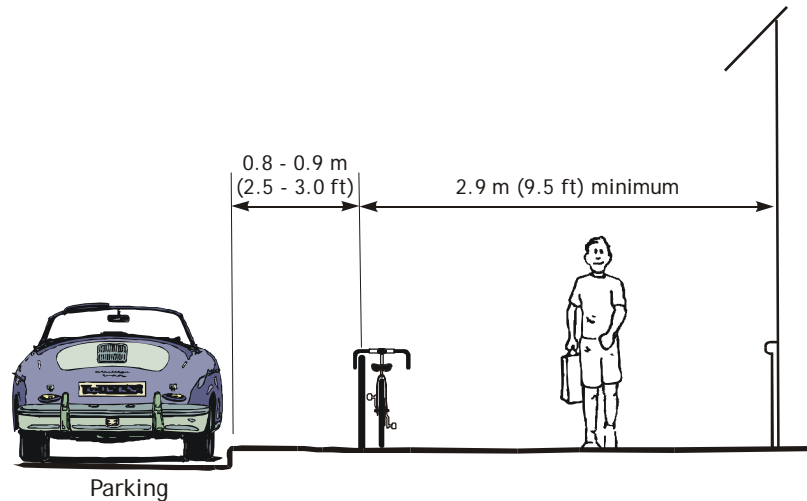

Figure 17-7. Illustration. Philadelphia’s standard for bike rack placement in business districts.

Source: *City of Philadelphia Bicycle Parking Specifications*⁽⁶⁾

17.5 Student Exercise

Exercise A

Do an inventory of need for bicycle storage facilities and a preliminary site design for an activity center in your community.

Exercise B

Develop a bicycle parking ordinance for your local community. Have students consider the features discussed in this chapter.

17.6 References and Additional Resources

The references for this lesson are:

1. Williams, J., B. Burgess, and B. Wilkinson, *Implementing Bicycle Improvements at the Local Level*, FHWA, Publication No. FHWA-RD-98-105, Washington, DC, 1998.
2. *Bicycle Parking Criteria, Bike Rack, Bicycle Locker, Cycle Stands & Bike Storage Systems*, IBF, 2004, available online at <http://www.ibike.org/engineering/parking.htm>, accessed March 9, 2004.
3. *Bicycle Parking Guidelines*, Association of Pedestrian and Bicycle Professionals, Spring 2002, available online at <http://www.apbp.org/pdfs/bikepark.pdf> or <http://www.bicyclinginfo.org/pdf/bikepark.pdf>, accessed March 23, 2004.
4. *Guide for the Development of Bicycle Facilities*, AASHTO, Washington, DC, 1999.
5. *Code of Ordinances*, City of Madison, WI.
6. *City of Philadelphia Bicycle Parking Specifications*, 1998.

Additional resources for this lesson include:

- *Bicycle Parking*, Bicycling Info Website, available online at <http://www.bicyclinginfo.org/de/park.htm>, accessed April 12, 2004.
- *Bicycle Parking Facility Guidelines*, City of Portland, OR, Office of Transportation, available online at <http://www.trans.ci.portland.or.us/bicycles/parkguide.htm>, accessed April 20, 2004.
- Fletcher, Ellen, *Bicycle Parking*, 1990.
- *Pro Bike News*, Bicycle Federation of America, April 1996.
- *Source Book of Designs, Manufacturers, and Representatives*, Bicycle Federation of America, 1992.

LESSON 18:

BICYCLE AND PEDESTRIAN CONNECTIONS TO TRANSIT

18.1 Introduction

Bicycling and walking typically account for one-fourth to one-half of all personal trips in European cities, as well as the vast majority of all public transportation access trips, even in lower density suburban areas. This stands in sharp contrast to the United States, where the share of personal trips made by nonmotorized means fell in recent decades to less than 10 percent, and where automobile park-and-ride accounts for a major share of suburban transit access.⁽¹⁾

In city after city, transit agencies are rediscovering that good bicycle and pedestrian access is a critical component of the success of the transit system. It has been estimated that 53 percent of the American public lives within 3.2 km (2 mi) of a public transit route. Walking is the most environmentally friendly and low-cost way to get people to and from public transportation. When given sidewalks or traffic-calmed streets to walk along, safe and convenient ways to cross streets, and a comfortable and attractive environment, most people are willing to walk farther to reach public transportation.

In the United States, however, lack of attention to pedestrian needs beyond the bounds of the transit station seems fairly common. The locations of park-and-ride lots are often not amenable to nonmotorized access. One transit agency commented that all of their park-and-ride lots are located near freeways and/or shopping areas where residential housing is quite far away, and no paths or sidewalks are located near the park-and-ride lots.

Some U.S. transit and transportation agencies are, nevertheless, turning a promisingly sharper focus on the larger environment that surrounds and leads to transit stations and bus stops. A variety of facilities and services are being provided to improve the interface between bicycling and transit: bike racks on buses; provisions for the transport of bicycles on light- and heavy-rail transit, commuter rail, and long-distance trains; bike parking at transit stations; design improvements at transit stations (curb cuts, signing, and lighting); links to transit centers (bike lanes, multiuse trails, and widened roadway shoulders); and multipurpose Bikestations[®] which cater to the bicycle commuter.

The U.S. Congress has emphasized the connection of transit with bicycle and pedestrian facilities in Federal transportation legislation by providing several funding sources for bicycle and pedestrian improvements through the FTP, among other programs.

This lesson discusses the history of bicycle and pedestrian access to transit in the United States and provides an overview of how bicycling and walking are being integrated with transit. Case studies from the United States and Europe describe successful projects.

The major sections of this lesson are as follows:

- 18.1 Introduction.
- 18.2 Interagency Cooperation.
- 18.3 Why Link Bicyclists With Transit Services?
- 18.4 Bike-on-Bus Programs.

- 18.5 Bike-on-Rail Programs.
- 18.6 Example Transit Access Programs.
- 18.7 Bicycle Parking Facilities at Transit Stations.
- 18.8 Bikestations.
- 18.9 What Are the Key Elements of Successful Programs?
- 18.10 Student Exercise.
- 18.11 References and Additional Resources.

18.2 Interagency Cooperation

While U.S. transit authorities have expended considerable planning and engineering efforts to meet pedestrian needs in the interiors of transit stations, in many cases, little attention has been devoted to either the pedestrian or bicycling environment to and from stations. Poorly developed interjurisdictional and interagency cooperation often impedes consideration of the door-to-door experience of using public transportation. It is not unusual for several different agencies to maintain independent control over the various facilities that are used by someone walking or bicycling to and from a single transit stop.

Unless these agencies agree to cooperate together in assessing, planning, and enhancing nonmotorized transit access, major impediments to pedestrian and bicycle access may persist or grow in severity. Local and State governments with the authority to manage, maintain, and construct pedestrian and bicycle facilities and roads should cooperate with transit agencies and interested citizens in developing action programs to reduce barriers to bicycle and pedestrian access to transit.

18.3 Why Link Bicyclists With Transit Services?

Integration enhances travel potential for both modes of travel by offering a number of advantages that each mode alone cannot provide:

- Bike-on-transit service enables bicyclists to travel greater distances and overcome topographical barriers.
- Bike-on-transit services to recreational destinations during off-peak periods can increase overall transit ridership and increase efficient use of capacity.
- Bicycle-to-transit services (trails, on-road bike lanes, and bike parking) enlarge transit's catchment area by making it accessible to travelers who are beyond walking distances from transit stations.

Integration lowers air pollutant emissions from trips taken on public transit. Outside of central business districts, most commuters using rail transit and park-and-ride lots arrive by auto; typical trip lengths are 3 to 6 km (5 to 10 mi). For an auto trip of 11 km (7 mi), nearly 90 percent of the emissions occur in the first 1.6 km (1 mi), known as the cold-start stage. Either converting transit access trips from auto to bike or converting car commutes to bike-and-ride transit trips can produce significant emission reductions.⁽²⁾

18.4 Bike-on-Bus Programs

Bike-on-bus programs are functionally similar to bike-on-rail programs, but often operate in much lower density corridors than rail transport. By expanding a bus line's access and egress service area, bike-on-bus programs can attract many passengers who would not otherwise be able to use transit for their trip, particularly to reach suburban destinations where transit coverage is often sparse.

There are two means of accommodating bicycles on buses—placing them on front-mounted racks and allowing them inside the bus. Rear-mounted racks were the earliest system, but for operational and safety reasons, preferences have shifted toward front-mounted racks (see figure 18-1).



Figure 18-1. Photo. The preferred style of bike rack mounts to the front of the bus.

When considering bike-on-bus programs, agencies typically cite two main concerns:

Schedule Adherence. A 1994 study completed through the Transit Cooperative Research Program (TCRP) shows that most transit agencies are not experiencing problems with schedule delays resulting from accommodating bicyclists; new designs of bike-on-bus racks have minimized dwell times for loading and removal.⁽³⁾

Safety and Protection of Transit Property. The study has also shown that the impact of bicycle-transit integration has been minimal on the personal safety of bicyclists, operators, and the public, and on transit agency property. Bike racks on the fronts of buses have not proven to interfere with driving. Because of concerns about bicycles aboard crowded trains during rush hours, some commuter rail programs have limited bike-on-train access to off-peak hours.

Most U.S. bike-on-bus services do not require a permit. While some U.S. transit systems accommodate bikes only on designated routes, others, such as Phoenix, AZ, Aspen, CO, and Sacramento, CA, have no route restrictions and have opened their entire system to carrying bicycles (see figure 18-2).



Figure 18-2. Photo. Some transit agencies allow bicyclists to carry their bikes onto buses.

The City of Phoenix, AZ, began a 6-month bike-on-bus demonstration program from March through August 1991 to assess potential use of the service. Bicycle racks were mounted on the front of buses operating on three routes that were selected based on criteria developed in coordination with the bicycle community. Two-thirds of the \$15,000 program cost came from a grant by the Arizona Department of Environmental Quality (ADEQ). During the demonstration program, 5,500 bicycle trips were taken and ridership steadily increased. At the end of the first month, 153 riders had used the service. By the end of the third month (May), this jumped to 1,109 riders per month; by the end of 6 months, there were 1,404 riders per month. Phoenix Transit reported no safety problems associated with the new service. The service not only attracted increasing numbers of bicyclists, but also attracted to transit people who did not previously use buses. A bike rider survey found that the vast majority (90 percent) of the bus riders used the bike racks for commuting. An evaluation of the demonstration concluded: ⁽²⁾

From the response received, it would not be a stretch to say that the program was overwhelmingly popular among transit riders and [was] hailed as an excellent idea by bike riders. For bus patrons it is an added option, for bike riders it is an opportunity, and for public transit it is another step toward reducing the number of vehicles traveling on the road.

As a result of the successful demonstration, the Phoenix Transit bike-on-bus program was expanded systemwide in July 1992. By 1997, all 463 buses in the Phoenix system were equipped with front-mounted bike racks, each of which carried two bikes. A survey in 1997 found that there were 2,146 daily users of the bike racks within Phoenix alone (not including use outside of Phoenix).

The success of the Phoenix program quickly caught the attention of other transit agencies and it is now estimated that more than one in five transit buses in the country are equipped with bike racks. In 1993, the Seattle/King County, State of Washington transit agency, Metro, used more than \$900,000 of Congestion

Mitigation and Air Quality (CMAQ) funds to equip every one of its 1,200 buses with racks. The agency now boasts more than 40,000 bicycle-carrying passengers every month. The racks were designed and supplied by a northwestern U.S. firm whose racks now carry more than 250,000 riders each month on systems throughout the country.

The Tompkins Consolidated Area Transit (TCAT) agency in Ithaca, NY, used STP funds to install racks on its 42 buses in August 1996. After one year, it was carrying 1,000 bicyclists a month. The agency estimates that, within the city, 1.2 bicycles are carried for every 100 passengers.

In California, the Santa Clara Valley Transportation Authority (SCVTA) has equipped all its buses with bike racks and allows up to two bikes inside each bus, at the driver's discretion, when the racks are full. During off-peak hours, the Sacramento Regional Transit District allows one bike inside each standard length 12.2-m (40-ft) bus not equipped with a front rack.⁽⁴⁾

Although most transit agencies offering bike-on-bus services have relied on various devices outside the bus, a few agencies have decided that such hardware is unnecessary and have allowed bicycles inside their buses instead. Westchester County Department of Transportation (WCDOT), located near New York, NY, simply adopted a permissive "welcome aboard" policy toward bicyclists and other potential users, beginning in the late 1970s. The space provided for passengers who use wheelchairs could be used by those traveling with baby carriages, shopping carts, bulky packages, or bicycles. This policy applied only to accessible Advanced Design Buses (ADB) and only in off-peak periods. Wheelchair users were given priority over bicycles at all times. No problems had been reported with the service.

18.5 Bike-on-Rail Programs

Most light and heavy rail systems now provide some level of access to bicyclists and their bicycles (see figure 18-3). In systems with dedicated bike racks inside the rail cars (e.g., Caltrain® and SCVTA in California), the only restrictions relate to capacity and points of access to the train. In systems without dedicated space (e.g., Portland, OR, Washington, DC, and Boston, MA), riders may take bicycles on board except during the morning and evening peak hours and on festival and other major event days.

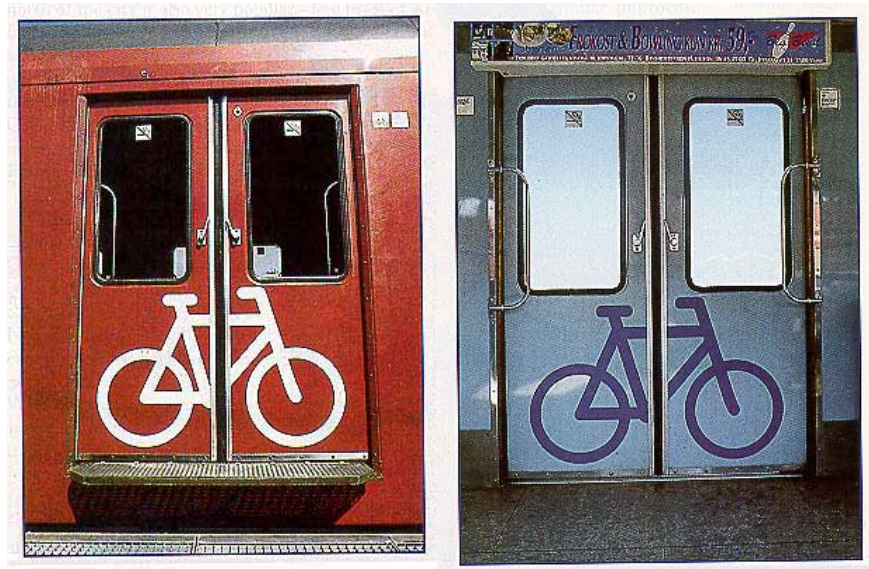

Figure 18-3. Photos. Bicycle stencils on doors of Danish State railways indicate those cars where bikes may be brought on the train.

The Tri-County Metropolitan Transportation District of Oregon (Tri-Met) light rail system (known as MAX) in Portland, OR, is one of the few systems still requiring riders to obtain a permit before bringing bikes on board. The permit costs \$5 and requires the rider to watch an 8-minute safety and operation video. Like a number of other transit agencies, the Washington [DC] Metropolitan Area Transit Authority (WMATA) eliminated its permit requirement for bringing bicycles on Metro trains. This simplifies travel for bike-transit users and encourages more bike-transit trips (<http://www.wmata.com>).

Almost 2,000 bicyclists a day bring their bikes on board the 110-km (70-mi) Caltrain passenger rail line between San Francisco, CA, and Silicon Valley. Each train has space for 24 bikes (some trains may have 2 bike cars, for a capacity of 48 bikes), up from just 4 spaces when the program began in 1992. More than half of a recent ridership jump of 7 percent was attributable to bicyclists. The initial \$30,000 investment by San Francisco County, plus another \$30,000 from Caltrain to expand capacity, was repaid in farebox revenue within 6 months. Demand for bicycle spaces is now so great that Caltrain recently started offering two rented bicycle lockers for the price of one in an effort to persuade bicyclists to keep bikes at both ends of their trip rather than bring their bike on board.⁽⁴⁾

Time Restrictions

In the United States, nearly all bike-on-rail services are restricted to times outside weekday peak hours. The exceptions are the Bay Area Rapid Transit (BART) in San Francisco, CA, and the commuter rail system in Boston, MA, which allows bicycles to be carried during peak hours in the “reverse commute” direction only. Restrictions on most systems prohibit bicycles on rail weekdays before 9 or 9:30 a.m. (some allow bikes before 6 a.m.) and from 3 or 3:30 p.m. to 6:30 p.m. Weekend policies vary, with some systems having no restrictions and some blocking out certain hours when there is substantial shopping, work, or recreational travel. Several European bike-on-rail systems, including Oslo and Amsterdam, have no restrictions on the times when bicycles can be brought on board. Without any restrictions, bicyclists, using their own common sense, tend to avoid bringing bicycles into rail cars during crowded rush hours. SCVTA leads the United States in adopting the most European attitude toward bike-on-rail, allowing two bicycles per car in peak hours, and four per car in off-peak hours.

Rail Car Design Constraints

Restrictions on the number of bikes permitted on each rail transit system vary. Some systems permit two bicycles per car; others allow bicycles only on the last car of the train, with a maximum of four bicycles per train. Rail transit system restrictions on the number of bicycles permitted are based in part on rail car designs available in the United States, for which bicycle accommodation has not been a consideration. On the Metropolitan Atlanta Rapid Transit Authority (MARTA) system in Atlanta, GA, and on other systems, bicyclists hold their bikes in a foldup seat area near the back door of the rail car.

In California, design of the new California Car rail car, mandated and funded by Proposition 116, requires accommodation of a reasonable number of bicycles carried on board by passengers for both intercity and commuter applications. The California Car is a bilevel car that superficially resembles Amtrak’s® Superliner®, but with significant design differences, including bicycle storage on the lower level of the car. This new rail car, for use on State-sponsored Amtrak and local commuter rail services, is a promising new development in the United States. Its specifications could be adapted by other rail agencies to enhance bicycle-rail linkage.

18.6 Example Transit Access Programs

The City of Charlotte, NC, began a project in 1981 to encourage walking and bicycle access to bus transit along its heavily traveled Central Avenue Corridor, which contains seven intersections at a LOS of E or F

during the peak hours. To help address bicycle access needs, bicycle racks and lockers were installed at key bus stops. Pedestrian access was improved by installing 114 pedestrian signals and 115 pushbuttons at key intersections, and sidewalks were constructed with curb-cut ramps.

In July 1996, the Maryland Transit Administration (MTA) initiated a statewide inventory of access for bicycles and pedestrians at 111 existing and planned light, heavy, and commuter rail stations throughout the State. The goal was to identify the availability and condition of roadways and facilities at or near rail stations to determine what improvements would be needed to accommodate, in a safe and effective manner, pedestrians and bicyclists. The inventory was funded with \$160,000 of FTA State planning and research program money and \$40,000 of State matching funds. Data were collected within a 3-km (2-mi) radius for bicycles and a 1-km (0.6-mi) radius for pedestrians on a wide range of items including:

- Availability of bicycle racks and lockers.
- Condition and availability of sidewalks, crossings, and bicycle access surrounding stations.
- Traffic conditions such as traffic volumes and speed.
- Lane widths, surface conditions, parking, and bridges.
- Traffic mix and related considerations.

The information was used to target improvements by the Maryland Department of Transportation (including MTA) and local governments and to generate a greater understanding of the importance of adequate access to public transportation.⁽⁴⁾

18.7 Bicycle Parking Facilities at Transit Stations

Cities and transit authorities across the country are beginning to recognize the crucial role of secure bicycle parking at transit stations in promoting increased bicycle access to transit (see figure 18-4). A number of the Nation's commuter rail and rail transit systems are investing in bicycle parking, but many lack a more comprehensive strategy that looks at the environment beyond the station. Frequently, the quality of the parking provided is inadequate, leaving most bicycles vulnerable to theft and vandalism. The majority of suburban bus transit systems, which could expand service area and ridership through bicycle-transit interface, appear to pay little, if any, attention to bicycle parking facilities at bus stops.



Figure 18-4. Photo. Lack of adequate bike parking is a common problem at urban subways.

There is wide variation in the use of bicycle racks and lockers at rail stations and transit systems. Two crucial factors appear to be the degree to which the environment leading to the station is bicycle-friendly and the quality of the bicycle parking provided. In areas where separate bicycle paths or bike lanes on streets have been implemented, facilitating connection to rail or bus services, the ease and safety of access by bicycle is greatly enhanced. Access to many stations, however, passes through streets where little or no thought has been given to bicycle safety, which curtails the extent of this access. The degree to which a transit agency actively promotes its bicycle parking facilities, and more broadly, promotes the environmental and social benefits of bicycle access versus auto access, directly impacts the use of bicycle lockers and racks.

18.8 Bikestation

Bikestations provide another innovative method of integrating bicycles with transit and supporting bicycle transportation in general. The Bikestation concept originated in Europe and Japan and essentially is a holistic approach to providing everything the bicyclist needs in one location. A typical Bikestation can include secure indoor bike parking, a repair shop, bike sales and rentals, car sharing services, changing rooms, route and transit information, and a variety of other support services. The first Bikestation in the U.S. opened in Long Beach, CA. A number of other cities throughout the country have either already built Bikestations or are in the process of planning new Bikestations, including Seattle, WA, Palo Alto, CA, and Washington, DC. Individual Bikestations are typically developed by franchises (either nonprofit or for profit) and are membership-based.

18.9 What Are the Key Elements of Successful Programs?

Demonstration Projects

Many successful programs began with a limited demonstration phase and then expanded to a broader, or even systemwide, operation. Demonstration projects tend to focus on identifying and solving specific technical and operational aspects of the service and usually lead to wider program implementation.

Advisory Committees

Such a committee should include nonagency organizations and individuals who have experience in bicycle advocacy in their community, an interest in bicycle-transit programs, knowledge of user needs and constituency characteristics, and some expertise in bicycle and/or transit issues.

Marketing and Promotion

A bike-transit program must vigorously market and promote in order to be effective: a brochure describing the agency's program, a telephone number for information, and drawings or photographs of equipment to help users understand operating procedures.

Tri-Met in Portland, OR, distributed 4,000 brochures directly to the local bicycle advocacy group's membership. In Philadelphia, PA, the Southeastern Pennsylvania Transportation Authority (SEPTA) prepared a pamphlet highlighting eight scenic and cultural destinations for bicycle touring that were accessible by its local rail systems. Bike-to-Work Days and bicycle fairs or offers of free test rides have also proven effective in promoting new programs.

18.10 Student Exercise

Exercise A

Choose a local transit station (or individual transit stop) and determine the potential catchment area. Design a program for increasing bicycle and pedestrian access to the transit station, including both design improvements and education/promotion efforts. For physical improvements, include both the immediate vicinity and the connections to origins that lie in the catchment area.

Exercise B

Choose a nearby transit stop or park-and-ride station and ride a bike or walk to it. Document the problems along the way, as well as those you experience when you arrive at the station/stop. Given your knowledge of the community, what would it take to get people to bicycle and walk to this site?

18.11 References and Additional Resources

The references for this lesson are:

1. “Case Study No. 17: Bicycle and Pedestrian Policies and Programs in Asia, Australia, and New Zealand,” *National Bicycling and Walking Study*, Publication No. FHWA-PD-93-016, FHWA, Washington, DC, 1993.
2. “Case Study No. 9: Linking Bicycle/Pedestrian Facilities With Transit,” *National Bicycling and Walking Study*, Publication No. FHWA-PD-93-012, FHWA, Washington, DC, 1992.
3. *Integration of Bicycles and Transit, TCRP Synthesis 4*, TCRP, TRB, National Research Council, Washington, DC, 1994, available online at <http://gulliver.trb.org/publications/tcrp/tsyn04.pdf>.
4. *Bicycles and Transit: A Partnership that Works*, FTA and FHWA, Washington, DC, 1999.

Additional resources for this lesson include:

- “The Economic and Social Benefits of Off-Road Bicycle and Pedestrian Facilities,” National Bicycle and Pedestrian Clearinghouse Technical Assistance Series, No. 1, FHWA, Washington, DC, 1995, available online at http://www.imba.com/resources/science/econsoc_benefits.html

LESSON 19:

GREENWAYS AND SHARED-USE PATHS

19.1 Introduction

Shared-use paths provide low-stress environments for bicycling and walking that are separate from motor vehicle traffic. They can be great places for novice and child bicyclists to try out their bicycling skills prior to taking trips on urban streets. Shared-use paths are frequently in high demand among bicyclists, joggers, in-line skaters, people walking dogs, people with disabilities, and a variety of other users. Systems of shared-use paths in urban and suburban communities serve as the arterials of the bicycle and pedestrian transportation system. They serve as a complement to and extension of onstreet facilities (not as alternatives to them) and offer the protection from motor vehicle traffic that many Americans seek when looking to leave their car behind in favor of a bike, walk, or skate.

The popularity of many urban paths has shown that large volumes of pathway traffic, with a diverse user mix, can create congested and conflictive path conditions similar to that on urban highways. Therefore, planning and design of shared-use paths must be done with the same care and attention to recognized guidelines and user needs as the design of on-roadway bikeways and other transportation facilities.

The following discussion addresses planning and design issues common to most shared-use path facilities, including how to accommodate various user types, address different right-of-way settings, and achieve various safety standards and guidelines. More detail on shared-use path design and engineering is provided in national guidelines established by FHWA, the U.S. Architectural and Transportation Barriers Compliance Board (the Access Board), and AASHTO. See specific resources listed in section 19.11. The major sections of this lesson are as follows:

- 19.1 Introduction.
- 19.2 Shared-Use Path Definition.
- 19.3 Shared-Use Path Users.
- 19.4 User Conflict.
- 19.5 Shared-Use Path Types and Settings.
- 19.6 Planning.
- 19.7 Rail-Trails, Rails-with-Trails, and Towpaths.
- 19.8 Greenway Paths.
- 19.9 Paths Adjacent to Roadways.
- 19.10 Path Design.
- 19.11 Student Exercise.
- 19.12 References and Additional Resources.

19.2 Shared-Use Path Definition

The term shared-use path is defined by AASHTO as “a bikeway physically separated from motorized vehicular traffic by an open space or barrier and either within the highway right-of-way or within an independent right-of-way. Shared-use paths may also be used by pedestrians, skaters, wheelchair users, joggers, and other nonmotorized users.”⁽¹⁾ These facilities are most commonly designed for two-way

travel. In many communities, shared-use paths may also be referred to as trails, multiuse trails, bike paths, hiker/biker trails, or other similar terms.

19.3 Shared-Use Path Users

Shared-use paths are typically used by a diverse set of users representing different travel modes, using different types of equipment and traveling at different speeds (see figure 19-1). It is important to understand, even within the basic user categories of bicyclists, pedestrians, and skaters, how diverse path users can be. A recent study, *Characteristics of Emerging Road and Trail Users and Their Safety*, begins to document the various characteristics of these users and their equipment.⁽²⁾



Figure 19-1. Photo. To minimize user conflicts, adequate trail width is critical on paths having high volumes and diverse user mixes (Santa Barbara, CA).

- **Bicyclists** include adults using traditional bicycles, but also child bicyclists, cyclists pulling trailers or trail-a-bikes, and riders of tandem bicycles, recumbent bicycles, hand cycles, tricycles, and a variety of four-wheeled human-powered vehicles.
- **Pedestrians** include joggers, runners, and people walking dogs and pushing strollers, as well as disabled people. Today, disabled and injured people have a wide variety of assistive devices available to aid in travel or enable participation in trail activities, including powered and manual wheelchairs, powered scooters, tricycles, hand cycles, and racing wheelchairs, as well as the more traditional, crutches, walkers, and canes.
- **Skaters** include users as diverse as in-line skaters, kick scooters, skateboarders, and people using roller-skis.

In some communities, multiuse trails are designed and managed to accommodate equestrians, cross-country skiers, mountain bikers, and other users of specialized recreational activities. In general, the present discussion of shared-use paths does not specifically address the needs and issues of these more specialized user groups.

Shared-use paths do not typically allow use by motorized vehicles such as cars, motor scooters, motorcycles, go-carts, or recreational all-terrain vehicles (ATVs); however, there are important exceptions to consider in planning and design:

- Access for emergency, police, and maintenance vehicles.
- Use of electric wheelchairs, scooters, or other devices by disabled persons.
- Use of electric bicycles, electric push scooters, or other means of electric locomotion (if permitted by Federal-aid program regulations), at the discretion of local or State government.
- In rural areas, use of snowmobiles in winter.

Some shared-use paths may be appropriate for equestrian use. Some States claim that Federal law or regulation prohibits equestrian use on shared-use paths that use transportation funds. This is not true: there is no such Federal law or regulation. While the projects must serve a transportation function, nothing prohibits recreational use, and nothing requires a prohibition of equestrian use. There are various design options to allow equestrian use, such as providing both a paved path and an unpaved path within the same right-of-way.

In addition to diverse users and a variety of equipment used, shared-use paths serve a wide variety of trip purposes. User behavior, such as travel speed and willingness to make stops, varies considerably with different trip purposes. Especially in urban and suburban areas, paths are routinely used for commuting to work or school, running errands, visiting friends, getting exercise, observing nature, and seeking recreation and enjoyment of the outdoors.

Moreover, people of all ages and abilities use and enjoy shared-use paths—from the very young to the very old, from the novice cyclist to the marathon trainer. Accommodating and balancing the various needs created by this diverse user market is a central challenge for today’s shared-use path planners and designers.

19.4 User Conflict

User conflicts can emerge when user goals differ. In *Conflicts on Multiple-Use Trails*, Moore urges trail planners, designers, and managers “not to treat conflict as an inherent incompatibility among different trail activities, but as goal interference attributed to another’s behavior.”⁽³⁾ In addition to following good trail planning and design principals, Moore describes how user conflicts can be successfully minimized through effective path management.

Understanding the diverse social and operational needs of expected users and designing trails to accommodate projected volumes and mode mixes is critical to building successful trail systems—trails that will serve multiple roles in a community’s transportation and recreation network.

19.5 Shared-Use Path Types and Settings

Shared-use paths can be developed on a variety of rights-of-way and exist in many types of settings, including urban, suburban, exurban, and rural. Increasingly long paths use a variety of rights-of-way and pass through many diverse environments. The following is a list of the most common shared-use path types:

- **Rail-trails**—Paths created on abandoned railroad corridors.

- **Rails-with-trails**—Paths created adjacent to active rail lines (see figure 19-2), such as freight railroads, commuter rail lines, light rail, or other rail transit facilities.



Figure 19-2. Photo. Shared-use paths can be adjacent to railroad lines (Libba Cotton Trail, Carrboro, NC).

- **Greenway trails**—Paths incorporated into linear natural areas such as parks or conservation areas, along stream or river corridors, along waterfronts (see figure 19-3) including beaches and shorelines, or along flood control levees, etc.
- **Paths adjacent to highways, roads, and parkways**—Sometimes referred to as *sidepaths*.
- **Towpaths**—Paths created along abandoned canals by using the towpath or canal bed.
- **Paths using utility corridors**—Such as power lines, water supply, or sewer corridors, irrigation canals, or other utility lines.
- **Other paths**—Such as those developed within university campuses, on other institutional properties, or within large residential and/or commercial developments.

A wide variety of other facilities are often referred to by the terms path, pathway, or trail. They may share similarities with shared-use paths, but they are not addressed in this course. These include nature and interpretive trails, primitive and backcountry hiking trails, historic trails, heritage trails and touring routes, and walking paths.



Figure 19-3. Photo. Shared-use paths can be integrated into urban waterfronts and parks, providing direct access to central business districts (East Bay Bicycle Path, Providence, RI).

19.6 Planning

Greenways: A Guide to Planning, Design and Development and *Trails for the Twenty-First Century* are two well-researched resources on the subject of planning that both emphasize its importance in the process of creating a shared-use path.^(4,5) Three key objectives that should be addressed during the planning phase comprise communicating a clear vision, goals, and concept for the facility; building community support; and developing a comprehensive corridor assessment. Other plan components may include: documentation of community benefits and opportunities, environmental impact assessments, preliminary cost estimates, funding and phasing options, and implementation plans. Public involvement, interagency coordination, and interjurisdictional coordination should also be considered during early planning activities.

Trails for the Twenty-First Century offers a helpful guide to planning process terminology and includes four key steps in the pathway planning process:⁽⁵⁾

1. Trail vision or concept
2. The master plan
3. Preliminary design
4. Construction drawings and documents

Too often, agencies charged with creating a shared-use path fail to understand or adopt a crucial pathway planning principal—that by definition, shared-use paths serve both transportation and recreation functions. As such, they must be planned and designed to be a part of two systems of community infrastructure: parks and recreation, and transportation.

19.7 Rail-Trails, Rails-with-Trails, and Towpaths

More than 20,117 km (12,500 mi) and 1,200 rail and canal trails are now in place nationwide. More than 61 rails-with-trails and 25 towpaths are included in these totals. Unused rail and canal corridors offer many benefits as trail conversions, including gentle grades, existing base and sub-base for path construction, access to the center of communities, historic preservation and revitalization opportunities, scenic and natural resource preservation, and creation of social linkages from the past to the future. These types of pathways also present unique planning and design challenges. The following issues are especially important, since many of them have received extensive study and best-practice analysis (see “References” in section 19.11):

- Right-of-way acquisition and landownership issues.
- Liability issues.
- Bridge, tunnel, stonewall, and other structure reuse and rehabilitation issues.
- Potential historic resource impacts.
- Potential environmental contamination.

19.8 Greenway Paths

The most common feature of many greenways is a trail...with so many types of users in the United States, there are many types of trails, and elementary though it may seem, it is important to distinguish among them. All greenway trails should be compatible with the natural landscape and its functions.⁽⁴⁾

What distinguishes the typical greenway path from other types of shared-use paths is that the path is only one component of a larger corridor, which is primarily defined by its environmental features or functions, including waterways, forests, wetlands, shorelines, or other natural or restored landscapes. Moreover, the reason that the corridor exists may not be primarily to create a context for a path, but for larger environmental purposes such as habitat preservation, to absorb and accommodate floodwaters, or to provide parkland and recreation resources for human communities.

Greenway paths may be incorporated into built natural areas such as linear urban parks or parkways, along flood control levees or along urban waterfronts. Greenway paths can also be created in natural areas such as along beaches and shorelines, in conservation areas, or along stream or river corridors.

Greenway paths present unique planning and design challenges. The following issues are especially significant, as many of them have received extensive study and best-practice analysis:

- Positioning the pathway within the greenway corridor.
- Minimizing and managing environmental disturbance and impact, both during path construction and as the path sustains ongoing use.
- Reducing stormwater runoff and protecting against erosion.
- Incorporating environmental restoration such as bioengineering and low-impact stormwater management techniques.
- Designing the trail to be compatible with or even reinforce the larger goals and purposes of the corridor.

19.9 Paths Adjacent to Roadways

In select circumstances, locating shared-use paths adjacent to roads may be the best or only option available. In settings such as parkways or roadways with little or no access on one side and sufficient space to provide a path and buffer, locating paths adjacent to roads may be preferable to other options. Roads or streets that have low motor-vehicle traffic volumes and/or low traffic speeds can also be viable candidates for accommodating sidepaths, especially to provide continuity for a path that is otherwise on an independent right-of-way, but has critical gaps.

However, in typical cases, if a two-way shared-use path is located immediately adjacent to a roadway, some operational problems are likely to occur. The extent of these problems will depend on the context and layout of the roadway, number and nature of cross-streets, driveways and access ramps, and adjacent motor vehicle travel speeds. The AASHTO *Guide for the Development of Bicycle Facilities* enumerates nine potential problems and safety issues that need to be given serious consideration when planning or designing a shared-use path adjacent to a roadway, as for example:⁽¹⁾

- When the bicycle path ends, bicyclists going against traffic will tend to continue traveling on the wrong side of the street. Likewise, bicyclists approaching a bicycle path often travel on the wrong side of the street in getting to the path. Wrong-way travel by bicyclists is a major cause of bicycle/automobile crashes and should be discouraged at every opportunity.
- At intersections, motorists entering or crossing the roadway often will not notice bicyclists coming from their right, as they are not expecting contraflow vehicles. Even bicyclists coming from the left often go unnoticed, especially when sight distances are poor.
- Although the shared-use path should be given the same priority through intersections as the parallel highway, motorists falsely expect bicyclists to stop or yield at all cross-streets and driveways. Efforts to require or encourage bicyclists to yield or stop at each cross-street and driveway are inappropriate and frequently ignored by bicyclists.

19.10 Path Design

AASHTO's updated (1999) *Guide for the Development of Bicycle Facilities* remains the primary design guide for shared-use paths. The MUTCD 2003 edition, "Part 9: Traffic Controls for Bicycle Facilities," is the primary source for guidance regarding signing and striping of shared-use paths.⁽⁶⁾

A number of new publications provide supplementary information, including:

- ADAAG.⁽⁷⁾
- *Accessible Rights-of-way: Sidewalks, Street Crossings, and Other Pedestrian Facilities: A Design Guide.*⁽⁸⁾
- *Characteristics of Emerging Road and Trail Users and Their Safety.*⁽²⁾
- *Designing Sidewalks and Trails for Access: Parts 1 & 2.*⁽⁹⁾
- *Draft Guidelines for Accessible Public Rights-of-Way.*⁽¹⁰⁾
- *Evaluation of Safety Design and Operation of Shared Use Paths: Users Guide and Final Report.*⁽¹¹⁾
- *Recommendations for Accessibility Guidelines: Outdoor Developed Areas, Final Report.*⁽¹²⁾
- *Trail Intersection Design Guidelines.*⁽¹³⁾

- *Trails for the Twenty-First Century.*⁽⁵⁾

The following highlights address important trail design issues using references from the texts listed above. The *AASHTO Guide* should be used as a companion text for this module.

Accessible Path Design

Because shared-use paths provide a transportation function, all newly constructed shared-use paths should be built to provide access for people with disabilities. In addition, existing shared-use paths should be improved to enhance access whenever possible. Key issues for accessibility include trail access points, grade, cross-slope, street crossings, curb ramp design, railings, and signage. A single source of access guidance for shared-use trails has not been compiled; however, taken together, the sources above address the essential topics.

- Surfaces can be paved (asphalt or concrete) or unpaved (crushed stone or aggregate), but should be firm, stable, and slip-resistant.
- Grades should generally be less than 5 percent, but can be up to 12.5 percent for short distances, such as 3 m (10 ft). Level landings or rest areas should be provided at appropriate intervals on grades steeper than five percent.
- Cross-slopes for drainage or superelevated curves should be no greater than two percent.

Trail Width and Striping

Under most conditions, the recommended paved width for two-directional trails is 3 m (10 ft); however 3.7- to 4.3-m (12- to 14-ft) widths are preferred where heavy traffic is expected (see figure 19-4). In select instances, a reduced width of 2.4 m (8 ft) can be adequate, especially if one or the other of the bicycle or pedestrian modes has a small percentage of overall use. A recent study, *Evaluation of Safety Design and Operation of Shared Use Paths*, found that from 3 to 4.9 m (10 to 16 ft), every additional foot in width significantly improves the LOS for bicyclists using shared-use paths.⁽¹¹⁾

This study also found that centerline stripes have a significant impact on how bicyclists tend to operate on shared-use paths:⁽¹¹⁾

A striped centerline has a strong impact on the bicyclist's perception of freedom to maneuver. This finding appears to support the intent of trail designers in providing a centerline, which is to clearly delineate two opposing travel lanes. A centerline reinforces the idea that to pass a slower moving user, the cyclist may need to use the travel lane of opposing trail users, and should pass only when the opposing lane is open...there may be valid safety reasons for providing a centerline stripe, particularly on crowded trails, on curves with limited sight distance, and in other appropriate circumstances.

Additional details regarding striping and marking of paths are found in MUTCD.

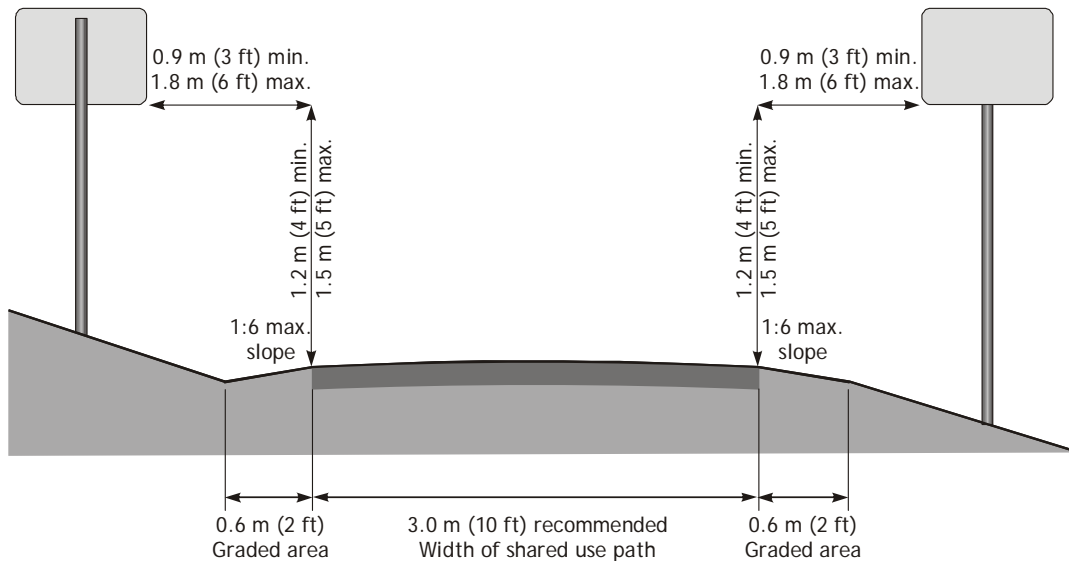

Figure 19-4. Illustration. Typical cross section for multiuse trails.

Source: American Association of State Highway and Transportation Officials⁽¹⁾

Trail/Roadway Intersection Design

According to page 46 of AASHTO's *Guide for the Development of Bicycle Facilities*:⁽¹⁾

Intersections between paths and roadways are often the most critical issue in shared-use path design. Due to the potential conflicts at these junctions, careful design is of paramount importance to the safety of path users and motorists alike. The solutions provided in this chapter should be considered guidelines, not absolutes. Each intersection is unique and will require sound engineering judgment on the part of the designer as to the appropriate solution.

The following are principles of intersection design taken from *Trail Intersection Design*, AASHTO, and other sources:^(13,1)

- Design for the full spectrum of trail users—young and old, slow and fast, bicyclists, skaters, and walkers, etc.
- Site the crossing area at a logical and visible location.
- When assigning right-of-way, give trail users at least the same rights as the motoring public, and provide clear right-of-way assignment.
- Provide positive guidance for trail users and motorists to ensure full awareness of the intersection. Warning signs and pavement markings (see figure 19-5) that alert motorists of the upcoming trail crossing should be used in accordance with MUTCD.



(This picture shows bicyclists not wearing helmets. FHWA strongly recommends that all bicyclists wear helmets.)

Figure 19-5. Photo. Signs, bollards, and trail and crosswalk markings alert both motorists and bicyclists to this midblock trail crossing.

Source: PBIC Image Library,
<http://www.pedbikeimages.org>

- Minimize conflicts and channelize the intersection to separate conflicting movements.
- Design unavoidable conflicts to occur at right angles.
- Optimize sight triangles, thereby ensuring proper stopping, intersection crossing, and decision sight distances. Conflicts should be clearly visible.
- Reduce motor-vehicle speed through traffic-calming techniques, as appropriate.
- Use design to ensure appropriate trail user speeds approaching and through the intersection. Wherever possible, intersections and approaches should be on relatively flat grades.
- Minimize trail user crossing distance with a median refuge area or by narrowing the roadway as appropriate.
- Provide adequate staging and refuge areas for trail users; use trail edge railings or posts to give stopped bicyclists a handhold that allows them to stop and maintain a ready posture for crossing without taking their feet off the pedals.
- Discourage unwanted motor vehicle intrusion onto the trail while enabling emergency and maintenance vehicle entry.
- Avoid unnecessary obstacles and barriers, and visibly highlight necessary obstacles. At signalized intersections:
 - Minimize trail user delay by minimizing traffic signal cycle time.
 - Provide adequate signal crossing time for design pedestrians.
 - Provide tactile/audible pushbuttons that are easily accessible for all types of trail users.

- Design to assist the trail user in looking in the direction of the potential hazard. Use signs and pavement markings on the trail to provide advance warning of upcoming intersections, especially in areas where the intersection is not clearly visible 75 m (250 ft) in advance.
- Consider the potential for sun blinding and lighting needs.
- Consider landscaping and other gateway treatments to draw motorists' and trail users' attention to intersections and to encourage slowing; however, take care to use designs that do not limit visibility and sight distances or demand trail users to make difficult maneuvers.

Other Design Issues

Quality shared-use path design requires a melding of skills from the fields of transportation engineering and landscape architecture. Guidance about basic engineering such as pavement structure, bridge loading, geometric design, and traffic safety must be combined with aesthetic, environmental, and cultural considerations such as attention to diverse human needs and the surrounding environmental and climatic conditions and integration with a community's identity and history. The following list of additional design issues is addressed in one or more of the design resources provided in section 19.11; these issues can also be researched on the Internet for case examples and guidance from documents developed by regional, State, or local agencies.

- Path surface and treadway design:
 - Hard and soft surfaces.
 - Boardwalks and bridge decks.
 - Separate treadways for wheels and heels.
 - Soils, subgrade, and geotechnical design.
- Geometric design issues:
 - Sight distance.
 - Slopes, grades, and cross-slopes.
 - Horizontal alignment.
- Providing access:
 - Stairs with bicycle rolling troughs for grade-separated crossings (see figure 19-6).
 - Access to abutting and cross-streets.
 - Controlled and uncontrolled access to adjacent properties.
 - Spur paths and trails.



Figure 19-6. Photo. Stairway with bicycle rolling troughs (Capital Crescent Trail, Bethesda, MD).

- Restricting access and separation from adjacent activities:
 - Restricting motor vehicle access.
 - Restricting path side access.
 - Paths adjacent to active railroads.
 - Fence, bollard, railing, and barrier design.
- Adjacent to roadway design issues:
 - Curbs.
 - Buffers.
 - Trail edge railings.
 - Roadway guide rails.
- Environmental controls and impacts:
 - Providing appropriate drainage.
 - Minimizing erosion.
 - Porous paving.
 - Trees and root systems.
 - Crossing wetlands.
 - Use of recycled materials and green building practices.
- Aesthetic issues:
 - Materials and use of color.
 - Landscaping.
 - Signs.

- Public art.
- Lighting.
- Amenities—location, citing, and design:
 - Bicycle parking.
 - Benches and rest areas.
 - Drinking water.
 - Restrooms.
 - Historic and cultural interpretation.
- Signing (see figure 19-7):
 - Wayfinding.
 - Identity.
 - Etiquette.
 - Regulatory.
 - Interpretive.
 - Informational.



Figure 19-7. Photo. Trailheads with parking and wayfinding signs assist shared-use path users (Rock Creek Trail, Montgomery County, MD).

- Structures and special crossings (see figure 19-8):
 - Bridges.
 - Tunnels.
 - Underpasses.
 - Retaining walls.
 - Culverts and drainage structures.
 - Railroad/trail crossings.
 - Bicycle/pedestrian ferries.



Figure 19-8. Photo. Bridges and floating sections allow paths to cross water and maintain continuity (Eastside Esplanade, Portland, OR).

- Lighting:
 - Safety and security.
 - Wildlife impacts.
- Trailheads and parking:
 - ADA accessibility.

19.11 Student Exercise

Visit and evaluate a trail facility in your area. Determine the positive elements and some of the issues of the facility, while paying close attention to the connection with on-street facilities, trail design, etc. Why might have the decision been made to build the facility in that manner, and what might be done to correct the issue?

19.12 References and Additional Resources

The references for this lesson are:

1. *Guide for the Development of Bicycle Facilities*, AASHTO, Washington, DC, 1999.
2. *Characteristics of Emerging Road and Trail Users and Their Safety*, FHWA, 2004, available online at <http://www.tfhrc.gov/safety/pubs/04104/index.htm>.
3. Moore, R., *Conflicts on Multiple-Use Trails*, FHWA, Publication No. FHWA-PD-94-031, available online at <http://www.fhwa.dot.gov/environment/conflicts/>, 1994, accessed November 22, 2004.

4. Flink, C., L. Schwarz, and R. Searns, *Greenways: A Guide to Planning, Design, and Development*, The Conservation Fund, 1993.
5. Flink, C., K. Olka, R. Searns, *Trails for the Twenty-First Century—Planning, Design, and Management Manual for Multi-Use Trails*, Second Edition, Island Press, Washington, DC, 2000, p. 30.
6. “Part 9—Traffic Controls for Bicycle Facilities,” MUTCD, FHWA, 2003, most recent edition available online at <http://mutcd.fhwa.dot.gov>.
7. ADAAG, Access Board, 2004, available online at <http://www.access-board.gov/ada-aba/final.htm>.
8. *Accessible Rights-of-Way: Sidewalks, Street Crossings and Other Pedestrian Facilities: A Design Guide*, Access Board, 1999, available online at <http://www.access-board.gov/provac/guide/PROWGuide.htm>.
9. *Designing Sidewalks and Trails for Access: Parts 1 & 2*, FHWA, Publication No.’s FHWA-HEP-99-006 and FHWA-EP-01-027, 1999 and 2001, available online at <http://www.fhwa.dot.gov/environment/bikeped/publications.htm>.
10. *Draft Guidelines for Accessible Public Rights-of-Way*, Access Board, 2002, available online at <http://www.access-board.gov/rowdraft.htm>.
11. *Evaluation of Safety, Design, and Operation of Shared-Use Paths*, FHWA, Washington, DC, 2005.
12. *Regulatory Negotiation Committee on Accessibility Guidelines for Outdoor Developed Areas, Final Report*, Access Board, 1999, available online at <http://www.access-board.gov>.
13. Pein, W., *Trail Intersection Design Guidelines*, Florida Department of Transportation, 1996, pp. 2–11, available online at http://www.dot.state.fl.us/Safety/ped_bike/handbooks_and_research/TRAILINT.PDF

Additional resources for this lesson include:

- *Design for Transportation Trails: Technical Brief No. 9*, National Bicycle and Pedestrian Clearinghouse, 1996, Available online (from the International Mountain Bike Association (IMBA) website) at <http://www.imba.com/>, accessed May 18, 2004.
- Drake, B., and D. Burden, *Pedestrian and Bicyclists Safety and Accommodation*, Participant Workbook, NHI Course No. 38061, FHWA-HI-96-028, 1996.
- *Pedestrian and Streetscape Guide: Toolkit 4—Trails and Paths*, Georgia Department of Transportation, 2003, available online at http://www.dot.state.ga.us/dot/plan-prog/planning/projects/bicycle/ped_streetscape_guide/toolkit%204%20final.pdf
- *Rail-Trails and Community Sentiment*, Rails-to-Trails Conservancy, 1998, available online at http://trailsandgreenways.org/resources/development/opposcom/tgc_commsentiment.pdf.
- *Rail-Trails and Liability*, Rails-to-Trails Conservancy, 2000, available online at http://www.trailsandgreenways.org/resources/development/opposcom/tgc_liability.pdf.

- *Rail-Trails and Safe Communities*, Rails-to-Trails Conservancy, 1998, available online at <http://www.enhancements.org/rtdocs/safecomm.pdf>.
- *Rails-with-Trails: Lessons Learned*, FHWA, 2005, available online at http://www.altaplanning.com/focus/rails_lessons.html.
- “Shared Use Paths” *PBIC Webpage*, 2004, Available online at <http://www.bicyclinginfo.org/de/shared.htm>, accessed April 26, 2004.
- *Towpaths-to-Trails*, Rails-to-Trails Conservancy, Washington, DC, 1995.
- Trapp, S., M. Gross, and R. Zimmerman, *Signs, Trails and Wayside Exhibits—Connecting People and Places*, UWSP Foundation Press, University of Wisconsin, Stevens Point, WI, 1994.
- *Tunnels on Trails*, Rails-to-Trails Conservancy, 2001, available online at <http://www.railtrails.org/whatwedo/information/tot.asp>.

LESSON 20:

TRAFFIC CALMING

20.1 Introduction

Traffic calming has been defined in *Traffic Calming: State of the Practice* as follows:⁽¹⁾

Traffic calming is the combination of mainly physical measures that reduce the negative effects of motor vehicle use, alter driver behavior and improve conditions for nonmotorized street users.

In this *State of the Practice* report, route modification, traffic control devices, and streetscaping were distinguished as being separate from traffic calming. In many cities, however, these techniques (as well as education and enforcement) are also included in traffic-calming programs. Figure 20-1 shows schematic examples of traffic-calming devices and elements.

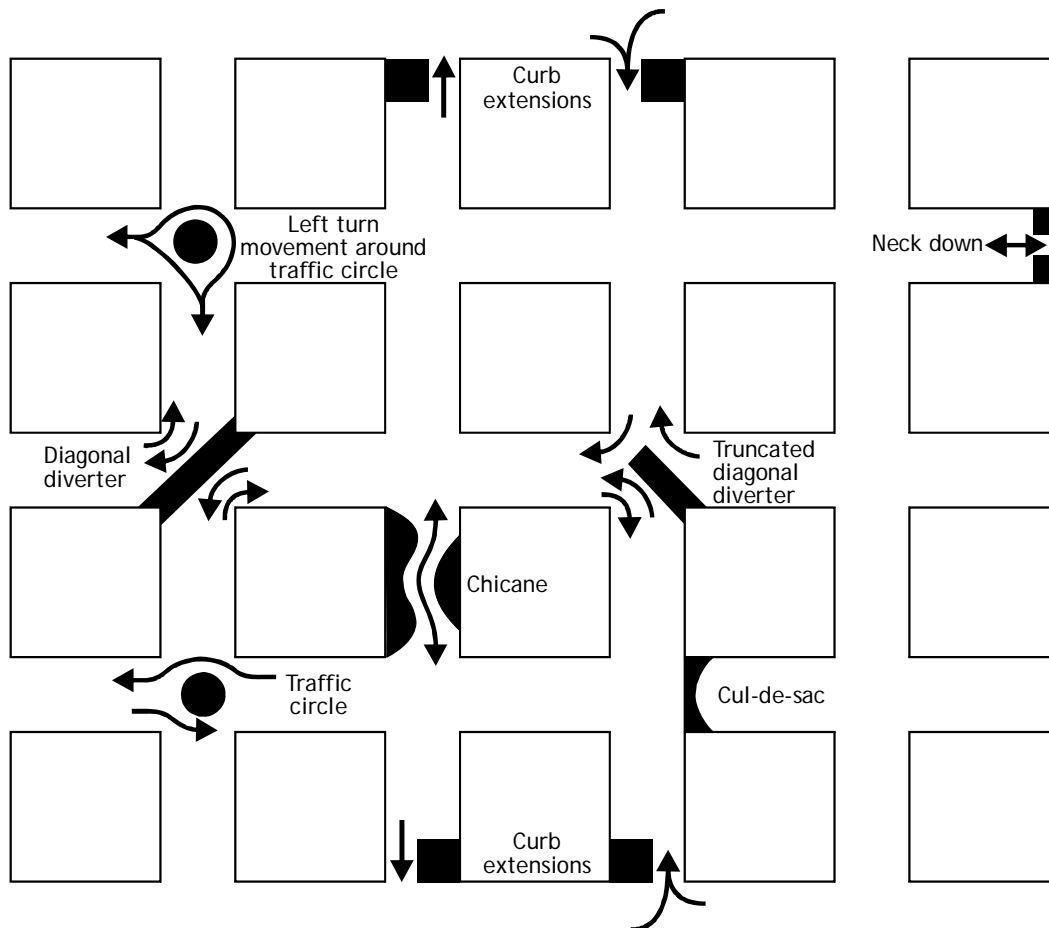

Figure 20-1. Illustration. Examples of traffic-calming elements.

This chapter explores the principles of traffic calming and provides a variety of studies, design details, and photographs of areas where traffic calming has been effectively used in the United States and in Europe. Along with the advantages of traffic calming, the text describes mistakes that practitioners have sometimes made in implementing traffic-calming techniques. The major sections of this lesson are as follows:

- 20.1 Introduction.
- 20.2 Traffic-Calming Objectives.
- 20.3 Traffic-Calming Issues.
- 20.4 Traffic-Calming Devices.
- 20.5 Traffic-Calming Impacts.
- 20.6 Putting the Design Techniques to Work: Selected Examples of Traffic Calming.
- 20.7 Student Exercise.
- 20.8 References and Additional Resources.

20.2 Traffic-Calming Objectives

The fundamental purpose of traffic calming is to reduce the speed and volume of traffic to acceptable levels for the street functional class and nature of adjacent land use. Although secondary impacts are not as clearly quantified, some observers link the reductions in traffic speed and vehicle volume to:

- Improved pedestrian and bicyclist safety.
- Decreased traffic noise.
- Improved neighborhood cohesion and livability.
- Improved property values.
- Improved street aesthetics and appearance (see figure 20-2).



Figure 20-2. Photos. Traffic-calming devices are used to break up long, uninterrupted street vistas that encourage speeding.

20.3 Traffic-Calming Issues

When any new traffic-management approach is introduced, issues, concerns, and questions are bound to arise. Design decisions related to traffic can have far-reaching consequences. Lives, economic well-being, and urban livability are directly affected.

Professional engineers, planners, government, and the public all are aware of and sensitive to proposals for changes in the traffic environment. Roadway congestion, air quality, traffic safety, street crimes, and

the high cost of new improvements are among the most widely debated issues in America today. New design ideas are, and should be, subjected to rigorous testing and evaluation before being accepted as part of the standard engineering and transportation-planning tool kit. Traffic calming is not a cure-all for urban transportation woes, but it can have significant benefits in many situations.

It is also important to consider the overall context of a traffic concern before the decision is made to implement traffic-calming techniques. In many cases, traffic-calming measures are installed to treat an area with a traffic problem, but the cause of the problem is not considered. There may be, for instance, a problem on a major arterial (such as an intersection with poor signal timing) that is backing up traffic and causing motorists to take alternate routes through adjacent residential streets (see figure 20-3). Adding traffic-calming devices to control speeds and volumes along the minor roadways would not be necessary if the source of the problem (the signal timing on the principal arterial) were corrected. In other words, transportation planners and engineers should look to treat the disease—not the symptom—of poor traffic management.

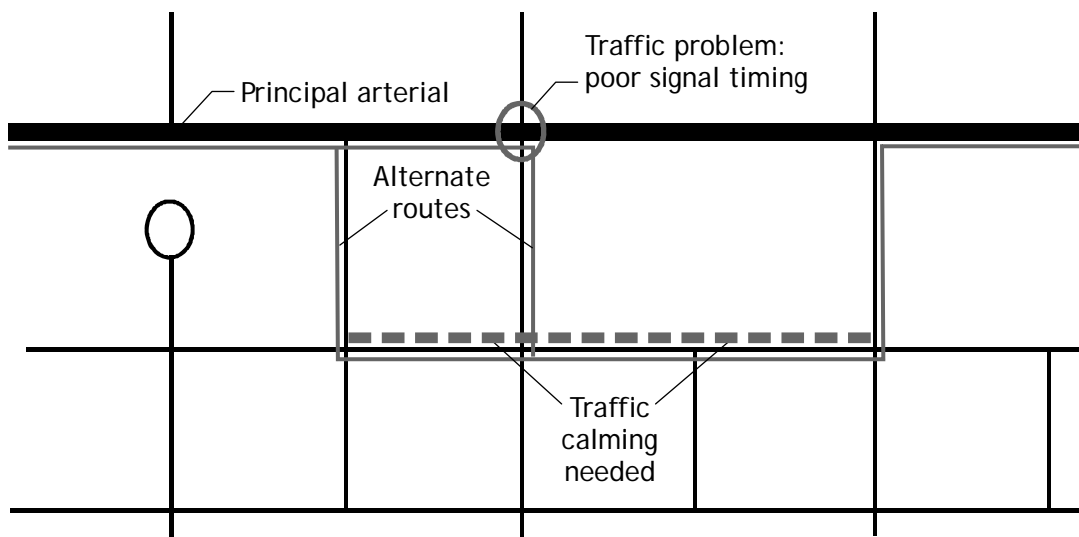

Figure 20-3. Illustration. Traffic calming may not be necessary if the original problem is corrected.

Fire and emergency services personnel should be consulted in the early stages of traffic calming programs (see figure 20-4). Their input into the type of location of traffic calming will ensure that emergency response times are not being significantly affected. Their support and acceptance of traffic calming may also tend to foster public support as well.



Figure 20-4. Photo. Emergency vehicle access should always be considered when incorporating traffic-calming measures.

20.4 Traffic-Calming Devices

Traffic calming has many potential applications, especially in residential neighborhoods and small commercial centers. Traffic-calming devices can be grouped within the following general categories:

- Bumps, humps, and other raised pavement areas.
- Reduced street areas (where motor traffic is given priority).
- Street closures.
- Traffic diversions.
- Surface texture and visual devices.
- Parking treatments.

Frequently, a combination of traffic-calming devices is used. Examples of such combinations will be discussed briefly, including:

- The woonerf.
- Entry treatments across intersections.
- Shared surfaces.
- Bicycle boulevards.
- Slow streets.
- Channelization changes.
- Traffic calming on a major road.
- Modified intersection design.

Bumps, Humps, and Other Raised Pavement Areas

This category includes all traffic-calming devices raised above pavement level. Included in this category are:

- Speed hump (see figure 20-5).
- Raised crosswalk (see figures 20-6 and 20-7).
- Raised intersection.



Figure 20-5. Photo. Speed humps can be combined with curb extensions and a winding street alignment.



Figure 20-6. Photo. Where possible, cyclists should be provided with cycle slips that enable them to bypass speed humps.



Figure 20-7. Photo. Raised crosswalks can slow traffic and give pedestrians a level surface at the crossing.

Table 20-1 contains brief descriptions of each treatment and design considerations.

Table 20-1. Description of bumps, humps, and other raised areas.

Device	Description	Design Considerations
Speed bump	<ul style="list-style-type: none"> • A raised area in the roadway pavement surface extending transversely across the travel way. • Generally has a height of 7.6 to 15.2 cm (3 to 6 in) and a length of 0.3 to 1 m (1 to 3 ft). 	<ul style="list-style-type: none"> • Most effective if used in a series at 91.4- to 152.4-m (300- to 500-ft) spacing. • Typically used on private property for speed control—parking lots, apartment complexes, private streets, and driveways. • Not conducive to bicycle travel and may not be pedestrian accessible.
Speed hump	<ul style="list-style-type: none"> • A raised area in the roadway pavement surface extending transversely across the roadway. • Normally has a minimum height of 7.6 to 10.1 cm (3 to 4 in) and a travel length of approximately 3.7 m (12 ft). • May raise the roadway surface to the height of the adjacent curb for a short distance. • Can be round or flat-topped; the flat-topped configuration is sometimes called a speed table. • Can extend the full width of the road or curb to curb, or can be cut back at the sides to allow bicycles to pass and facilitate drainage. A single hump acts as only a point speed control. To reduce speeds along an extended section of street, a series of humps is usually needed. Typically, speed humps are spaced at between 91.4 and 182.8 m (300 and 600 ft) apart. 	<ul style="list-style-type: none"> • If midblock pedestrian crossings exist or are planned, they can be coordinated with speed hump installation since vehicle speeds will be lowest at the hump to negotiate ramps or curbs between the sidewalk and the street. • Must be visible at night. • Should be located to avoid conflict with underground utility access to boxes, vaults, and sewers. • Should not be constructed at driveway locations. • May be constructed on streets without curbs, but steps should be taken to prevent circumnavigation around the humps in these situations. • Adequate signing and marking of each speed hump is essential to warn roadway users of the hump's presence and guide their subsequent movements. • Should not be installed in street sections where transit vehicles must transition between the travel lane and curbside stop. • To the extent possible, speed humps should be located to ensure that transit vehicles can traverse them perpendicularly.
Raised crosswalk	<ul style="list-style-type: none"> • Essentially a broad, flat-topped speed hump that coincides with pedestrian crosswalks at street intersections. • Raised above the level of the roadway to slow traffic, it enhances crosswalk visibility and makes the crossing easier for pedestrians who may have difficulty stepping up and down curbs. 	<ul style="list-style-type: none"> • Must be stable and firm and can be constructed of brick, concrete block, colored asphalt, or cement, with ramps striped for better visibility. • A raised crosswalk is applicable: <ul style="list-style-type: none"> ○ On roadways with vehicular speeds perceived as being incompatible with the adjacent residential land uses. ○ Where there are a significant number of pedestrian crossings. ○ In conjunction with other traffic-calming devices, particularly entry treatments. ○ On residential streets of two lanes or less that are classified as either local streets or neighborhood collector streets. ○ On roadways with 85th percentile speeds less than 72 km/h (45 mi/h).

Table 20-1. Description of bumps, humps, and other raised areas—Continued

Device	Description	Design Considerations
Intersection hump/raised intersection	<ul style="list-style-type: none"> Raises the roadway at an intersection, forming a type of plateau across the intersection, with a ramp on each approach. Situated at curb level, a plateau can be enhanced through the use of distinctive surfacing such as pavement coloring, brickwork, or other pavements. In some cases, the distinction between roadway and sidewalk surfaces is blurred. If this is done, physical obstructions such as bollards or planters should be considered, restricting the area to which motor vehicles have access. 	<ul style="list-style-type: none"> Ramps should not exceed a maximum gradient of 16 percent. Raised and/or textured surfaces can be used to alert drivers to the need for particular care. Distinctive surfacing helps reinforce the concept of a calmed area and thus plays a part in reducing vehicle speeds. Distinctive surfacing materials should be skid-resistant, particularly on inclines. Ramps should be clearly marked to enable bicyclists to identify and anticipate them, particularly under conditions of poor visibility. Care must be taken so the visually impaired have adequate cues to identify the roadway's location (e.g., tactile strips). Color contrasts will aid those who are partially sighted.

Bellevue Example

Table 20-2 below provides the findings for a before-and-after study of speed humps installed in Bellevue, WA, in order to reduce speeds in the area.

Table 20-2. Bellevue, WA, speed hump findings.

Location	Street Type/Width	No. of Humps	Hump Spacing m (ft)	Speed Limit km/h (mi/h)	Before		After	
					85th % Speed km/h (mi/h)	Daily traffic	85th % Speed km/h (mi/h)	Daily traffic
Somerset Drive SE	Two-way, 12.2-m-wide (40-ft-wide) local residential neighborhood street	2	103.6 (340)	40.2 (25)	62.8 (39)	795	43.5 (27)	541 (increased to 746 when the hump was reduced from 1.9 to 7.6 cm (0.75 to 3 in))
Highland Drive SE	Two-way, 10.7-m-wide (35-ft-wide) neighborhood collector	3	67.1 (220)	40.2 (25)	57.9 (36)	1,700	40.2 (25)	No change because no alternative route exists
166th/162nd Avenue SE	Two-way, 11.0-m-wide (36-ft-wide) local residential street; walk-to-school route	2	182.9 (600)	40.2 (25)	59.5 (37)	655	38.6 (24)	.017
		2	176.8 (580)	40.2 (25)	59.5 (37)	472	43.5 (27)	.017

Table 20-2. Bellevue, WA, speed hump findings—Continued

Location	Street Type/Width	No. of Humps	Hump Spacing m (ft)	Speed Limit km/h (mi/h)	Before		After	
					85th % Speed km/h (mi/h)	Daily traffic	85th % Speed km/h (mi/h)	Daily traffic
SE 63rd Street	Two-way, 10.7-m-wide (35-ft-wide) local residential street temporarily serving as a connection between two minor arterials	2	304.8	40.2	57.9	2,456	43.5	2,802
		3	(1,000) 152.4 (500)	(25)	(36)		(27)	
Yarrow Bay neighborhood	Primarily a neighborhood connector	2	121.9 (400)		62.8 (39)	3,585	40.2 (25)	2,931

Reducing Street Area

This category of traffic-calming techniques includes all those that reduce the area of the street designated exclusively for motor vehicle travel. Reclaimed space is typically used for landscaping, pedestrian amenities, and parking. Discussed here are:

- Slow points.
- Medians.
- Curb extensions.
- Corner-radius treatments.
- Narrow traffic lanes.

Street Narrowing

Two-way streets can be narrowed in a short distance, forcing motorists to slow and, in some cases, to merge into a single lane. Street narrowing is also referred to as neck-downs, traffic throttles, or pinch points. Sometimes these are used in conjunction with a speed table and coincident with a pedestrian crossing.

One-Lane Slow Point. One-lane slow points restrict traffic flow to one lane (see figure 20-8). This lane must accommodate motor traffic in both travel directions. Passage through the slow point can be either straight through or angled.

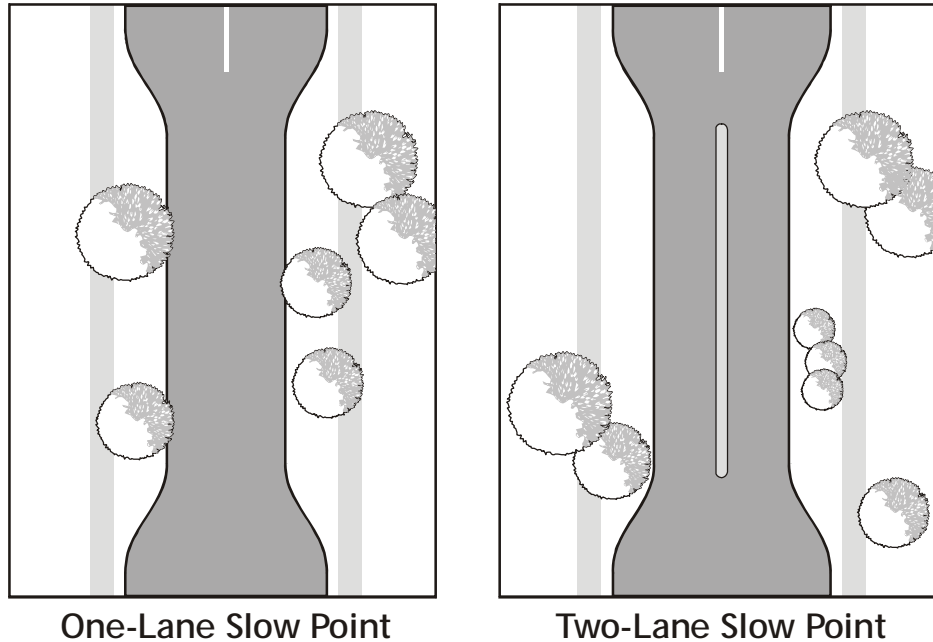

Figure 20-8. Illustration. Examples of one-lane and two-lane slow points.

Two-Lane Slow Point. Two-lane slow points narrow the roadway while providing one travel lane in each direction (see figure 20-8). The following design considerations should be made for two-lane slow points:

- Where slow points have been used in isolation as speed control measures, bicyclists have felt squeezed as motorists attempt to overtake them at the narrowing. Not all bicyclists have the confidence to position themselves in the middle of the road to prevent overtaking on the approach to and passage through the narrow area.
- To reduce the risk of bicyclists' being squeezed, slow points should generally be used in conjunction with other speed control devices such as speed tables at the narrowing. Slower moving drivers will be more inclined to allow bicyclists through before trying to pass. Where bicycle flows are high, consideration should be given to a separate right-of-way for bicyclists past the narrow area.
- A textured surface such as smooth brick or pavers may be used to emphasize pedestrian crossing movement. Substituting this for the normal roadway surface material may also help to impress upon motorists that lower speeds are intended.
- Such measures should not confuse pedestrians with respect to the boundary of the roadway area over which due care should still be taken. In particular, where a road is raised to the level of the adjacent sidewalk, this can cause problems for those with poor sight. However, a tactile strip may help blind people in distinguishing between the roadway and the sidewalk; similarly, a color variation will aid those who are partially sighted.
- Slow points can be used to discourage use of the street by large vehicles. They can, however, be barriers to fire trucks and other emergency vehicles. Some designs permit access by emergency vehicles by means of lockable posts or ramped islands.
- Slow points can enhance the appearance of the street. For example, landscaped islands can be installed, intruding into the roadway to form a narrow gate through which drivers must pass.

Landscaping enhances the neighborhood’s sense of nature and provides a visual break in views along the street.

- Slow points are generally only sanctioned where traffic flows are less than 4,000 to 5,000 vehicles per day. Above this level, considerable delays will occur during peak periods.
- Clear signing should indicate traffic flow priorities.

Table 20-3 displays the advantages and disadvantages of both one-lane and two-lane slow points.

Table 20-3. Advantages and disadvantages of slow points.

Treatment	Advantages	Disadvantages
One-lane slow point	<ul style="list-style-type: none"> • Vehicle speed reduced. • Most effective when used in a series. • Imposes minimal inconvenience to local traffic. • Pedestrians have a reduced crossing distance and greater safety. 	<ul style="list-style-type: none"> • Reduced sight distances if landscaping is not low and trimmed. • Contrary to driver expectations of unobstructed flow. • Can be hazardous for drivers and bicyclists if not designed and maintained properly. • Opposing drivers arriving simultaneously can create confrontation.
Two-lane slow point	<ul style="list-style-type: none"> • Only a minor inconvenience to drivers. • Regulates parking and protects parked vehicles as the narrowing can help stop illegal parking. • Pedestrian crossing distances reduced. • Space for landscaping provided. 	<ul style="list-style-type: none"> • Not very effective in slowing vehicles or diverting through traffic. • Only partially effective as a visual obstruction.

Medians

Medians are islands located along the roadway centerline, separating opposing directions of traffic movement. They can be either raised or flush with the level of the roadway surface. They can be expressed as painted pavement markings, raised concrete platforms, landscaped areas, or any of a variety of other design forms. Medians can provide special facilities to accommodate pedestrians and bicyclists, especially at crossings of major roadways (see figure 20-9).



Figure 20-9. Photo. This median refuge island provides railing and a staggered crossing area to direct pedestrian views toward oncoming traffic.

The following design considerations should be made for medians:

- Medians are most valuable on major, multilane roads that present safety problems for bicyclists and pedestrians wishing to cross. The minimum central refuge width for safe use by those with wheelchairs, bicycles, baby buggies, etc., is 1.6 m (5.2 ft) (2 m [6.6 ft] is desirable).
- Where medians are used as pedestrian and bicyclist refuges, internally illuminated bollards are suggested on the medians to facilitate quick and easy identification.
- Used in isolation, roadway medians do not have a significant impact in reducing vehicle speeds. For the purpose of slowing traffic, medians are generally used in conjunction with other devices such as curb extensions or roadway lane narrowing.

Several caveats apply:

- To achieve meaningful speed reductions, the travel lane width reduction must be substantial and visually obvious. The slowing, however, is temporary; as soon as the roadway widens again, traffic resumes its normal speed.
- Bicyclists are put at risk of being squeezed where insufficient room has been left between a central median and the adjacent curb. Experience shows that most drivers are unlikely to hold back in such instances to let bicyclists go through first. This threat is particularly serious on roads with high proportions of heavy vehicles.
- The contradiction between the need to reduce the roadway width sufficiently to lower motorist speeds, while at the same time leaving enough room for bicyclists to ride safely, must be addressed. This may be achieved by reducing the roadway width to the minimum necessary for a bicyclist and a motorist to pass safely (i.e., 3.5 m [11.5 ft]).

Here are three suggestions:

- Introducing color or texture changes to the road surface material around the refuge area reminds motorists to reduce speed.

- White striping gives a visual impression that vehicles are confined to a narrower roadway than that created by the physical obstruction—adjacent areas exist that vehicles can run over, but these are not generally apparent to approaching drivers.
- In some cases, provide an alternate, cut-through route for bicyclists (see figure 20-6).

Curb Extensions

The sidewalk and/or landscaped area on one or both sides of the road is extended to reduce the roadway to a single lane or minimum-width double lane. By reducing crossing distances, sidewalk widening can be used to make pedestrian movement easier and safer.

Reducing roadway width results in reductions of vehicle speed and delay. When curb extensions are used at intersections, the resultant tightened radii ensure that vehicles negotiating the intersection do so at slow speeds. The delay incurred by vehicles is also reduced by reducing the green time required for pedestrian crossings. The following design issues should be considered for curb extensions:

- They can be installed either at intersections or midblock.
- They may be used in conjunction with other traffic-calming devices.
- They are limited only to the degree that they extend into the travelway, but they cannot impede or restrict the operation of the roadway.
- Successful bicycle facilities need a clear separation from sidewalk and street pavement, with adequate distances from parked cars to avoid opening doors. Cross-traffic should be slowed to allow bicyclists better continuity and safety.
- Narrowing certain streets can, at the same time, create safer bicycle facilities, but care should be taken that bicyclists are not squeezed by overtaking vehicles where the road narrows. Encouraging motorists to let the bicyclists through first by using complementary traffic-calming techniques such as speed tables and cautionary signing or by leaving sufficient room for both to pass safely at the narrowing would be appropriate measures.
- If it is expected that a motorist should be able to pass a bicyclist, the minimum desirable width is 3.5 m (11.5 ft).
- Curb extensions can be employed to facilitate bicycle movement where a segregated multiuse trail crosses a busy street.

Corner Radius Treatment

Corner radii of intersection curbs are reduced, forcing turning vehicles to slow down. Efforts to accommodate trucks and other large vehicles have historically led to increased corner radii at intersections. To slow traffic, a corner radius of approximately 2.1 m (7 ft) is recommended (see figure 20-10).



Figure 20-10. Photo. A reduced radius allows for a slower, safer turn.

The following results have been observed:

- Large vehicles (trucks, vans, etc.) have more difficulty negotiating reduced radius corners.
- Pedestrian crossing distances are reduced by up to 1.2 m (4 ft) when the radius is reduced (see figure 20-11).
- The sharper turns that result from the reduced radii require motorists to reduce speed, increasing the time available to detect and take appropriate actions related to pedestrians at the crossing.
- Smaller radii provide more pedestrian storage space, and pedestrians are more visible to drivers.

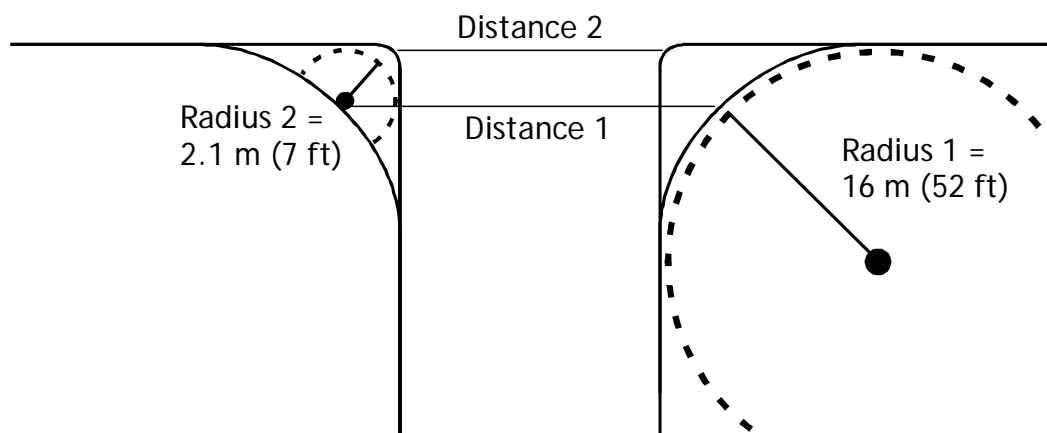

Figure 20-11. Illustration. When turning radii are reduced, the width of an intersection is reduced as well.

Narrow Traffic Lanes

Especially in residential areas, wide streets may not be necessary or desirable. Wide traffic lanes encourage faster motor vehicle speeds. Consideration should be given to the review of cross-sections for all street classifications to determine whether roadway lane widths can be reduced (within the AASHTO guidelines) so more area can be dedicated to bicycle and pedestrian use and associated traffic-calming facilities (see figure 20-12). Cross-section approaching the reduced-width street should also be slowed.



Figure 20-12. Photo. This traffic-calming measure uses a landscaped median to narrow the travel lanes.

One method of narrowing traffic lanes is called a road diet. While not a traditional traffic-calming technique, a road diet consists of converting a two-way street with four travel lanes to two travel lanes with a center turn lane and using the additional space for bicycle and pedestrian space. Additional information can be found in section 15.3. Table 20-4 displays advantages and disadvantages of corner radius treatments and narrowed traffic lanes:

Table 20-4. Advantages and disadvantages of corner radius and narrowed lane treatments.

Treatment	Advantages	Disadvantages
Corner radius treatment	<ul style="list-style-type: none"> • Can result in increased safety for pedestrians by reducing crossing distances and slowing the speed of turning vehicles. 	<ul style="list-style-type: none"> • May result in wide swings in turning movements of large vehicles. • May result in large vehicles hitting and damaging curbs or endangering pedestrians on corners. • May affect response times for emergency vehicles.
Narrow traffic lanes	<ul style="list-style-type: none"> • Additional area for landscaping and pedestrian facilities. • Reduced vehicle speeds and increased safety. 	<ul style="list-style-type: none"> • On-street parking may be restricted.

Street Closures

Three types of street closures are described in the following discussion:

- Complete street closures.
- Partial street closures.
- Driveway links.

Caution: Street closures must be considered in an areawide context, or traffic problems may simply shift to another nearby street.

Complete Street Closures

Street closures, generally on residential streets, can prohibit through-traffic movement or prevent undesirable turns. Street closures may be appropriate where large volumes of through-traffic or shortcut maneuvers create unsafe conditions in a residential environment. The following design issues should be considered before closing streets completely:

- Where proposals are likely to lead to a reduction in access, prior consultation with residents at early stages of planning and design is especially important to minimize opposition.
- The benefits of exempting bicyclists should be carefully considered in all cases.
- Bicycle gaps should be designed to minimize the risk of obstruction by parked vehicles. Painting a bicycle symbol and other directional markings on the road in front of the bicycle gap has proven to be effective.
- Bollards can reduce the parking obstruction (see figure 20-13).
- Bollards should be lighted or reflectorized to be visible at night.
- The design of bicycle gaps should permit good visibility of adjacent roads.
- Signing should acknowledge the continued route as a through-route for bicyclists.
- Clearly defined parking can reduce the problem of parked cars blocking the closure and bicycle gap.
- Police and fire departments should be consulted early in the design process to determine emergency access requirements. Often, removable bollards, crash gates, and card or key-operated gates can satisfy these requirements, combined with parking restrictions. A 6.1-m-wide (20-ft-wide) clear path is needed for emergency access.
- Tree planting, benches, and textured paving can enhance appearance.
- Street closures are recommended only after full consideration of all expected turning and reversing movements, including those of garbage trucks, fire trucks, and other large vehicles.



Figure 20-13. Photo. The design of street closures should provide specific parking areas to discourage obstruction of bicycle and pedestrian traffic.

Partial Street Closures

Access to or from a street is prohibited at one end, with a no-entry sign and barrier restricting traffic in one direction. The street remains two-way, but access from the closed end is permitted only for bicyclists and pedestrians. The following design issues should be considered before closing streets partially:

- As a general rule, bicycle and pedestrian exemptions should be provided and designed to minimize the likelihood of obstruction by parked vehicles.
- All signing should acknowledge the continued existence of a through-route for bicyclists and pedestrians.

Driveway Links

A driveway link is a partial street closure in which the street character is significantly changed so it appears to be a private drive. Typically, the roadway is narrowed and defined with textured or colored paving. A ribbon curb, landscaping, or bollards may be used to delineate roadway edges. Reclaimed roadway area is converted to pedestrian facilities and landscaping.

This is a very effective method of changing the initial impression of the street. If done right, drivers will not be able to see through. It appears as a road closure, yet allows through traffic.

The driveway link can provide access to small groups of homes and is especially applicable to planned residential developments. The go-slow feel of the driveway link is enhanced by design standards that eliminate vertical curb and gutter and use a relatively narrow driveway cross-section.

Traffic Diversion

Traffic diversion is one of the most widely applied traffic-calming concepts. It includes all devices that cause motor vehicles to slow and change direction to travel around a physical barrier (see figure 20-1). Physical barriers used to divert traffic in this fashion can range from traffic circles to trees planted in the middle of the road. The discussion in this lesson provides information on the following traffic-calming devices:

- Traffic diverters.
- Traffic circles.
- Roundabouts.
- Chicanes.
- Tortuous street alignments.

Traffic Diverters

Traffic diverters are physical barriers installed at intersections that restrict motor vehicle movements in selected directions. The diverters may be designed to prevent right- or left-hand turns, to block straight-ahead travel and force turns to the right or left, or to create a T-intersection. In all cases, paths, cut-throughs, or other provisions should be made to allow bicyclists and pedestrians access across the closure.

Traffic diverters can take many forms. In diagonal road closures and diversions, straight-through traffic movements are prohibited (see figure 20-14). Motorists are diverted in one direction only. Seattle, WA, installed truncated diagonal diverters, which allow right-turn movements around one end of the diverter. That city's engineering department found that these diverters disrupted neighborhood traffic and has focused instead on installation of traffic circles to control neighborhood traffic problems. Problems experienced with diverters included: (1) travel time and distance increased for all users; (2) local residents were diverted to other streets; (3) visitors and delivery services were often confused and delayed; and (4) emergency vehicle response times were potentially increased. Bollard design has evolved, and the technology exists to provide access to select groups by using remote devices to lower the bollards. Limiting access may require agency policies to admit only the select vehicles.



Figure 20-14. Photo. Diagonal road closures/diverters limit vehicular access but allow emergency vehicles to enter through removable bollards.

Turning movement diverters are installed at the intersection of a neighborhood street with a major street or collector to prevent cut-through traffic. They prevent straight-through movements and allow right turns only into and out of the neighborhood.

Table 20-5 displays the advantages and disadvantages of these two types of diverters:

Table 20-5. Advantages and disadvantages of diverters.

Treatment	Advantages	Disadvantages
Diagonal road closures/diverters	<ul style="list-style-type: none"> • Through-traffic is eliminated. • An area for landscaping is provided. • Conflicts are reduced. • Pedestrian safety is increased. • A bicycle pathway connection can be included. 	<ul style="list-style-type: none"> • Will inconvenience residents in gaining access to their properties. • May inhibit access by emergency vehicles unless they are permitted access or the street names are changed. • Will move through traffic to other streets if not back to the arterial.
Turning movement diverters	<ul style="list-style-type: none"> • Effective at discouraging cut-through traffic. • Relatively low cost. • Creates sense of neighborhood entry and identity. 	<ul style="list-style-type: none"> • Limits resident access. Should be installed as part of overall neighborhood circulation improvements to ensure reasonable convenience for residents. • Motorists may try to override the diverter to make prohibited turns unless vertical curbs, barriers, landscaping, or other means are used to discourage such actions.

Traffic Circles

Large traffic circles, or rotaries, with two or more lanes, have a history of high speeds, public confusion as to yield regulations, and high crash rates. They are generally not regarded well by the U.S. public. However, smaller traffic circles, with center islands approximately 4.0 m (13 ft) in diameter, can be safer for both vehicles and pedestrians. They can be used as traffic-calming devices at intersections and are effective in reducing vehicle speeds (see figure 20-15). Traffic circles can reduce crashes by 50 to 90 percent (when compared to two-way and four-way stop signs and other traffic signs) by reducing the number of conflict points at intersections. Success, however, depends on the central island being sufficiently visible and the approach lanes engineered to deflect vehicles, preventing overrun of the island. Traversable traffic circles on straight roads are less likely to produce the desired speed reduction. The discussion below on roundabouts also applies to small roundabouts, specifically their advantages and disadvantages.



Figure 20-15. Photo. Traffic circles can be designed to accommodate large vehicles and emergency access without undue restrictions.

Roundabouts

Traditionally, distinctions between modern roundabouts and other kinds of circular intersections, such as rotaries or traffic circles, are not always clear. Table 20-6 provides a breakdown of the differences between traffic circles and modern roundabouts. This table was adapted from the FHWA report, *Roundabouts: An Informational Guide*.⁽²⁾ Like traffic circles, roundabouts vary in size and number of lanes they accommodate. Table 20-7 shows the advantages and disadvantages of roundabouts. These conditions can change with the size and configuration of the roundabout.

Table 20-6. Comparison of roundabouts with traffic circles.

Source: *Roundabouts: An Informational Guide*⁽²⁾

Issue	Roundabout	Traffic Circle
Traffic control	Yield control is used on all entries. The circulatory roadway has no control.	Some traffic circles use stop control or no control, on one or more entries.
Priority to circulating vehicles	Circulating vehicles have the right of way.	Some traffic circles require circulating vehicles to yield to entering traffic.
Pedestrian access	Pedestrian access is allowed only across the legs of the roundabout, behind the yield line.	Some traffic circles allow pedestrian access to the central island.
Direction of circulation	All vehicles circulate counterclockwise and pass to the right of the central island.	Some neighborhood traffic circles allow left-turning vehicles to pass to the left of the central island.
Parking	No parking is allowed within the circulatory roadway or at the entries.	Some traffic circles allow parking within the circulatory roadway.

Table 20-7. Advantages and disadvantages of roundabouts.

Source: *Modern Roundabouts for Oregon*⁽³⁾

Category	Advantages	Disadvantages
Safety	<ul style="list-style-type: none"> • There are a reduced number of conflict points compared to uncontrolled intersection. • Lower operational speeds yield less severe and fewer crashes. • Slower speeds because of intersection geometry reduce crashes. 	<ul style="list-style-type: none"> • Since roundabouts are unfamiliar to the average driver in the United States, there is likely to be an initial period where crashes increase. • Signalized intersections can preempt control for emergency vehicles. •
Capacity	<ul style="list-style-type: none"> • Traffic <i>yields</i> rather than <i>stops</i>, often resulting in the acceptance of smaller gaps. • For isolated intersections, roundabouts should give higher capacity/lane than signalized intersections due to the omission of lost time (red and yellow) at signalized intersections. 	<ul style="list-style-type: none"> • Where the coordinated signal network can be used, a signalized intersection will increase the overall capacity of the network. • Signals may be preferred at intersections that periodically operate at higher than designed capacities.
Delay	<ul style="list-style-type: none"> • Overall delay will probably be less than for an equivalent volume signalized intersection (this does not equate to a higher LOS). • During the off-peak, signalized intersections with no retiming produce unnecessary delays to stopped traffic when gaps on the other flow are available. 	<ul style="list-style-type: none"> • Drivers may not like the geometric delays which force them to divert their cars from straight paths. • When queuing develops, entering drivers tend to force into the circulating streams with shorter gaps. This may increase the delays on other legs and the number of crashes.
Cost	<ul style="list-style-type: none"> • In general, less right-of-way is required. • Maintenance costs of signalized intersections include electricity, maintenance of loops, signal heads, controller, timing plans (roundabout maintenance includes only landscape maintenance, illumination, and occasional sign replacement). • Crash costs are low due to the low number of crashes and severity. 	<ul style="list-style-type: none"> • Construction costs may be higher. • In some locations, roundabouts may require more illumination, increasing costs. •
Pedestrians and bicyclists	<ul style="list-style-type: none"> • A splitter island provides a refuge for pedestrians that will increase safety. • At low speed and low traffic volume, roundabouts should improve safety for bicyclists. 	<ul style="list-style-type: none"> • A splitter island may cause difficulty to people using wheelchairs. • Tight dimensions of roundabouts create an uncomfortable feeling to bicyclists. • Longer paths increase travel distances for both pedestrians and bicyclists. • Roundabouts may increase delay for pedestrians seeking acceptable gaps to cross.

A roundabout is a channelized intersection at which all traffic moves counterclockwise around a central traffic island. These islands may be painted or domed, mountable elements may be curbed, and islands may also include landscaping or other improvements.

In 1989, a survey of crashes at roundabouts examined years of crash data for 447 sites in England, Wales, and Scotland.⁽⁴⁾ Table 20-8 compares the crash rates for roundabouts and signalized intersections. Key survey findings were:

- Roundabouts were most commonly used on streets with speed limits of 48 km/h (30 mi/h) or less.
- Roundabouts were found to have a far lower overall crash rate than that of signalized intersections with equivalent speed limits.
- Looking only at crashes involving bicycles, the study showed that four-arm roundabouts have about the same involvement rate (crashes per million vehicles of that type entering the intersection) as do conventional, four-legged, signalized intersections.

Table 20-8. Comparative crash rates for signalized intersections and roundabouts.
Source: Illustrated Guide to Traffic Calming⁽⁴⁾

Signalized Intersections*	Roundabouts*
<ul style="list-style-type: none"> • 2.65 crashes/intersection/year. • 34 crashes per 100 million vehicles. • 20% resulted in serious or fatal injury. 	<ul style="list-style-type: none"> • 0.83 crashes/intersection/year. • 20 crashes per 100 million vehicles. • 19% resulted in serious or fatal injury.

*Note: Both types of intersections compared have 48-km/h (30-mi/h) speed limits and are four-legged intersections.

Splitter islands are the islands placed within legs of the roundabout to separate entering and exiting traffic. They are designed to deflect entering traffic (see figure 20-16) and prevent hazardous, wrong-way turning movements.



Figure 20-16. Photo. The splitter islands should be raised and landscaped to prevent left-turning vehicles from taking a shortcut across the island.

These islands are important design elements that should be provided as a matter of routine wherever feasible. Without splitter islands, left-turning motorists have a tendency to shortcut the turn to avoid driving around the outside of the central island. The islands should, preferably, be raised and landscaped. If this is not possible, painted island markings should be provided. The following are other design issues that should be considered:

- Roundabouts should preferably have sufficiently raised and highly visible centers to ensure that motorists use them, rather than overrunning.
- Clear signing is essential.
- Complementary speed reduction measures such as road humps on the approach to roundabouts can improve safety.
- The design of roundabouts must ensure that bicyclists are not squeezed by other vehicles negotiating the feature. Yet, where possible, adequate deflection must be incorporated on each approach to enforce appropriate entry speeds for motor vehicles.

There has been discussion of how usable roundabouts are to all pedestrians, depending on the size of the roundabout. Pedestrian gap acceptance is difficult due to the unknown intention of the vehicle traveling around the circle (will they exit the circle or keep going to another approach?). However, initial evidence shows lower pedestrian crashes which may be due to lower speeds and reduced conflict points, and NCHRP project 3-78 is investigating the safety experience of roundabouts (<http://www4.trb.org/trb/crp.nsf/All+Projects/NCHRP+3-78>).

The Seattle, WA, Engineering Department (now known as the Seattle Department of Transportation) has experimented since the 1960s with a variety of neighborhood traffic control devices. The major emphasis of this Department's Neighborhood Traffic Control Program is installing roundabouts at residential street intersections. City staff report that about 30 roundabouts are built each year. A total of approximately 400 roundabouts have been installed to date. Each one costs about \$5,000 to \$6,000.

In Seattle, a roundabout is an island built in the middle of a residential street intersection. Each one is custom-fitted to the intersection's geometry; every roundabout is designed to allow a single-unit truck to maneuver around the central island without running over it. A 0.6-m (2-ft) concrete apron is built around the outside edge of the roundabout to accommodate larger trucks. The center island is generally 4.6 m (15 ft) in diameter. Large trucks, when maneuvering around the roundabout, may run over the apron. The interior section of the island is usually landscaped. The Seattle Engineering Department coordinates the design and construction of each roundabout with the Seattle Fire Department and school bus companies.

Roundabouts are installed at the request of citizens and community groups. Because there are more requests than funding to build them, the Seattle Engineering Department has created a system for evaluating and ranking the requests. Before a request can be evaluated, a petition requesting a roundabout must be signed by 60 percent of the residents within a one-block radius of the proposed location. Then, the intersection's collision history, traffic volume, and speeds are studied.

Chicanes

Chicanes are barriers placed in the street that require drivers to slow down and drive around them. The barriers may take the form of landscaping, street furniture, parking bays, curb extensions, or other devices (see figure 20-1).

The Seattle Engineering Department has experimented with chicanes for neighborhood traffic control. It has found chicanes to be an effective means of reducing speed and traffic volumes at specific locations under certain circumstances. A demonstration project at two sets of chicanes showed:

- Reduction of traffic volumes on the demonstration streets.
- Little increase in traffic on adjacent residential streets.
- Reduction of motor speeds and collisions.
- Strong support for permanent installation of chicanes by residents (68 percent).

The following issues should be considered when planning for and designing chicanes:

- In the interest of safe bicycle travel, bicycle bypasses and signs to indicate directional priority are suggested.
- A reduction in sight lines should not be used in isolation to reduce speeds; if used alone, this could be dangerous. Reduced sight lines may be appropriate to avoid excessive land taking or as a reinforcing measure only where other physical features are employed to reduce speed.
- Chicanes offer a good opportunity to make environmental improvements through planting. However, preference should be given to low-lying or slow-growing shrubs to minimize maintenance and ensure good visibility.
- Measures should be employed to ensure that chicanes are clearly visible at night.
- Where full closure or speed humps are not feasible, chicanes may be used to reduce traffic speeds. Many different layouts are possible, including staggered parking (on alternating sides of the road).

Curvilinear Roads

Roads can be designed to meander or turn sharply, slowing traffic and limiting views to discourage speeding. This technique can incorporate use of cul-de-sacs and courtyards. Curvilinear roads are generally planned as part of the design stage of a new road layout, rather than being superimposed on an existing layout. The siting of buildings is used to create a meandering road. The following design considerations should be made for tortuous roads:

- Designers should be aware of the need for accessibility to residential properties, both in terms of servicing and the needs of the individual. Tortuous roads will prove to be unpopular if they severely restrict accessibility.
- Where traffic is deliberately diverted onto a tortuous route—to avert town center congestion, for example—consider maintaining as direct a route as possible for bicyclists.
- Curvilinear roads (a.k.a., serpentine) are under study, but have not yet been approved, for use in Portland, OR. If approved, their use would be limited to residential streets of two or fewer lanes.
- Road design is limited by AASHTO standards for transition taper lengths.
- This traffic-calming device may require significant parking removal and should be used where parking removal is not an issue.

Surface Texture and Visual Devices

This category of traffic-calming devices includes signing, pavement marking, colored and textured pavement treatments, and rumble strips. These devices provide visual and audible cues about the traffic calmed area. Colors and textures that contrast with those prevailing along the roadway alert motorists to particular conditions, much as conspicuous materials increase bicyclist and pedestrian visibility. Signs and pavement markings also provide information about applicable regulations, warnings, and directions.

Signing and Pavement Markings

Installation of directional, warning, and informational signs and pavement markings should conform to the MUTCD guidelines, as applicable (see figure 20-17). Traffic-calming devices may be new to many people in the United States, and the signs and markings will help minimize confusion and traffic conflicts.



*(This picture shows bicyclists not wearing helmets.
FHWA strongly recommends that all bicyclists wear helmets.)*

Figure 20-17. Photo. These pavement markings at a median refuge delineate the crossing for motorists and provide visible cues to sighted pedestrians as to the location of the roadway edge.

Consider the following when designing signing and pavement markings:

- A part of the sign/pavement marking approach to mitigating traffic in residential areas includes painting of stripes/lines on the roadway and other patterns that are designed to have a psychological impact on drivers. Although such patterns are basically intended to slow vehicles rather than reduce traffic, they should make passage over residential streets less desirable than if the roadway were untreated, in effect, encouraging the use of alternative routes.
- Many of the patterns tried have had only marginal success. In a few cases, the average speed increased slightly. A pattern that is successful is that of painting transverse bands. Painted lines are applied to the road at decreasing intervals approaching an intersection or “slow-down” point.

They are intended to give the impression of increasing speed and motorists react by slowing down.

- In Drachten, The Netherlands, engineers are experimenting with removing all traffic signs and markings at intersections, thus forcing each vehicle, bicycle, and pedestrian movement to be negotiated individually toward a result of lower speeds and fewer crashes.

Pavement Texturing and Coloring

The use of paving materials such as brick, cobbles, concrete pavers, or other materials that create variation in color and texture reinforces the identity of an area as a traffic-restricted zone (see figure 20-18). Detectable markings are also used at curb ramps, blended transitions, raised crossings, etc.



Figure 20-18. Photo. Pavement treatments can be applied to the entire traffic-calmed area or limited to specific street uses.

The following issues should be considered regarding pavement texturing and coloring:

- The choice of materials should ensure that they do not pose a danger or deterrent to bicyclists or persons with disabilities. Cobbles present special difficulties, particularly for vehicles with narrow wheels and without the benefit of suspension. Such treatment is particularly discouraging for bicyclists on steep slopes, making it harder to maintain momentum when riding uphill. Thus, as a general rule, cobbles should not be employed. Similarly, pavers with chamfered edges impair a bicyclist's stability and should be avoided.
- The color and texture of the street surface are important aspects of the attractiveness of many residential streets. The variation from asphalt or concrete paving associated by most people with automobile territory signals to the motorist that he or she has crossed into a different residential zone where pedestrians and bicyclists can be expected to have greater priority.

20.5 Traffic-Calming Impacts

Chapter 5 of the ITE report, titled *Traffic Calming: State of the Practice*, contains a synthesis of traffic-calming impacts experienced in the United States and Canada.⁽¹⁾ The report draws from detailed information collected on traffic-calming programs in 20 featured communities, another 30 communities surveyed less extensively, and a parallel Canadian effort by the Canadian ITE and the Transportation Association of Canada. The following information and tables were derived exclusively from this source.

Traffic Speeds

Naturally, reducing traffic speeds is one of the primary goals of traffic calming. Table 20-9 includes a list of several traffic-calming devices used and the impact they have on the speeds downstream of the traffic measure. Note that, due to the limitations of the studies, the data presented in table 20-9 are case-specific and represent only ballpark estimates of general traffic-calming impacts.

Table 20-9. Speed impacts downstream of traffic-calming measures.

Source: *Traffic Calming: State of the Practice*⁽¹⁾

Traffic-Calming Device	Sample Size	Average 85th Percentile Speed After Calming km/h (mi/h)	Average 85th Percentile Speed Change After Calming km/h (mi/h)	Percentage Change (%)
3.7 m (12 ft) Humps	179	44.1 (27.4)	-12.2 (-7.6)	-22
4.3 m (14 ft) Humps	15	41.2 (25.6)	-12.4 (-7.7)	-23
6.7 m (22 ft) Humps	58	48.4 (30.1)	-10.6 (-6.6)	-18
Longer tables	10	50.9 (31.6)	-5.1 (-3.2)	-9
Raised intersections	3	55.2 (34.3)	-0.5 (-0.3)	-1
Traffic circles	45	48.8 (30.3)	-6.2 (-3.9)	-11
Narrowings	7	52.0 (32.3)	-4.2 (-2.6)	-4
One-lane slow points	5	46.0 (28.6)	-7.7 (-4.8)	-14
Half closures	16	42.3 (26.3)	-9.7 (-6.0)	-19
Diagonal diverters	7	44.9 (27.9)	-2.2 (-1.4)	-4

Traffic Volumes

The report, *Traffic Calming: State of the Practice*, states:⁽¹⁾

The effectiveness of traffic calming measures is also judged by impacts on traffic volumes. Volume impacts are much more complex and case-specific than are speed impacts. They depend on the entire network of which a street is a part, not just on the characteristics of the street itself. The availability of alternative routes and the application of other measures in areawide schemes may have as large an impact on volumes as do the geometrics and spacing of traffic calming measures.

In particular, volume impacts depend fundamentally on the split between local and through traffic. This split also affects speeds, but to a lesser degree. Traffic calming measures will not affect the amount of locally bound traffic unless they are so severe or restrictive as to “degenerate” motor vehicle trips.

What traffic calming measures may do is to reroute nonlocal traffic. Measures fall into three classes: those that *preclude* through traffic, which will be referred to as class I measures; those that *discourage* but still allow through traffic—class II measures; and

those that *are neutral* with respect to through traffic other than to slow it down—class III measures. Where individual measures fit into this scheme will, as already noted, be case-specific. It will depend on geometrics and spacing, quality of alternative routes, and other factors. Still, there may be some value in generalizing about *diversion potential*.

Portland, OR, reports more diversion with [4.27-m] 14-foot humps than [6.71-m] 22-foot tables, and more diversion with either than with traffic circles. San Diego, CA, and Seattle, WA, report significant diversion with standard [3.66-m] 12-foot humps but minimal diversion with traffic circles. In terms of the three classes defined above, speed humps appear to be class II measures, discouraging but still allowing through traffic. If a good alternative route exists, humps will divert through trips in substantial numbers. Traffic circles appear to be class III measures, causing minimal diversion even where good alternative routes exist. Speed tables [6.71 m (22 ft) and up] could fall into either class; diversion information is too limited to be sure.

Table 20-10 provides quantitative volume impacts of traffic-calming measures.

Table 20-10. Volume impacts of traffic-calming measures.

Source: *Traffic Calming: State of the Practice*⁽¹⁾

Traffic-Calming Device	Sample Size	Average Change in Volume (vehicles per day)	Average Percentage Change (%)
3.7 m (12 ft) Humps	143	-355	-18
4.3 m (14 ft) Humps	15	-529	-22
6.7 m (22 ft) Humps	46	-415	-12
Traffic circles	49	-293	-5
Narrowings	11	-263	-10
One-lane slow points	5	-392	-20
Full closures	19	-671	-44
Half closures	53	-1611	-42
Diagonal diverters	7	-501	-35

Collisions

The report, *Traffic Calming: State of the Practice*, states:⁽¹⁾

Perhaps the most compelling effect of traffic calming is in the area of safety. By slowing traffic, eliminating conflicting movements, and sharpening drivers' attention, traffic calming may result in fewer collisions. And, because of lower speeds, when collisions do occur, they may be less serious. What makes positive safety impacts so important is that opposition to traffic calming is often based principally on safety concerns and concerns related to emergency response.

It may be difficult to determine the safety impacts of a traffic-calming program. For a comprehensive view of the safety impact, it is important to examine a wide area, including streets with and without traffic calming.

Other Factors

It has been determined that traffic-calming techniques may also have a positive effect on:

- **Crime reduction:** Traffic calming encourages natural surveillance and access control.
- **Quality of street life:** Lower speeds and volumes after traffic calming encourage walking, bicycling, and street life.
- **Rise in property value:** Traffic calming eliminates or lessens negative externalities of motor vehicle use.
- **Noise reduction:** Due to a decrease in traffic speeds, noise is reduced.

20.6 Putting the Design Techniques to Work: Selected Examples of Traffic Calming

Most traffic-calmed streets utilize a combination of the devices just discussed (see Figure 20-1). The following are some examples:

- The woonerf.
- Entry treatments.
- Bicycle boulevards.
- Channelization changes.

The Woonerf

A woonerf (Dutch for “living yard”) combines many of the traffic-calming devices just discussed to create a street where pedestrians have priority, and the line between motor-vehicle space and pedestrian (or living) space is deliberately blurred (see figure 20-19). The street is designed so motorists are forced to slow down and exercise caution. Drivers, the Dutch say, do not obey speed limit signs, but they do respect the design of the street.

The woonerf (plural—woonerven) is a concept that emerged in the 1970s as planners gave increased emphasis to residential neighborhoods. People recognized that many residential streets were unsafe and unattractive and that the streets, which took up a considerable amount of land area, were used for nothing but motor vehicle access and parking. Most of the time, the streets were empty, creating a no-man’s-land separating the homes from one another.

The Dutch, in particular, experimented extensively with street design concepts in which there was no segregation between motorized and nonmotorized traffic and in which pedestrians had priority.

A law passed in 1976 provided 14 strict design rules for woonerven and resulted in the construction of 2,700 such features in the following 7 years.

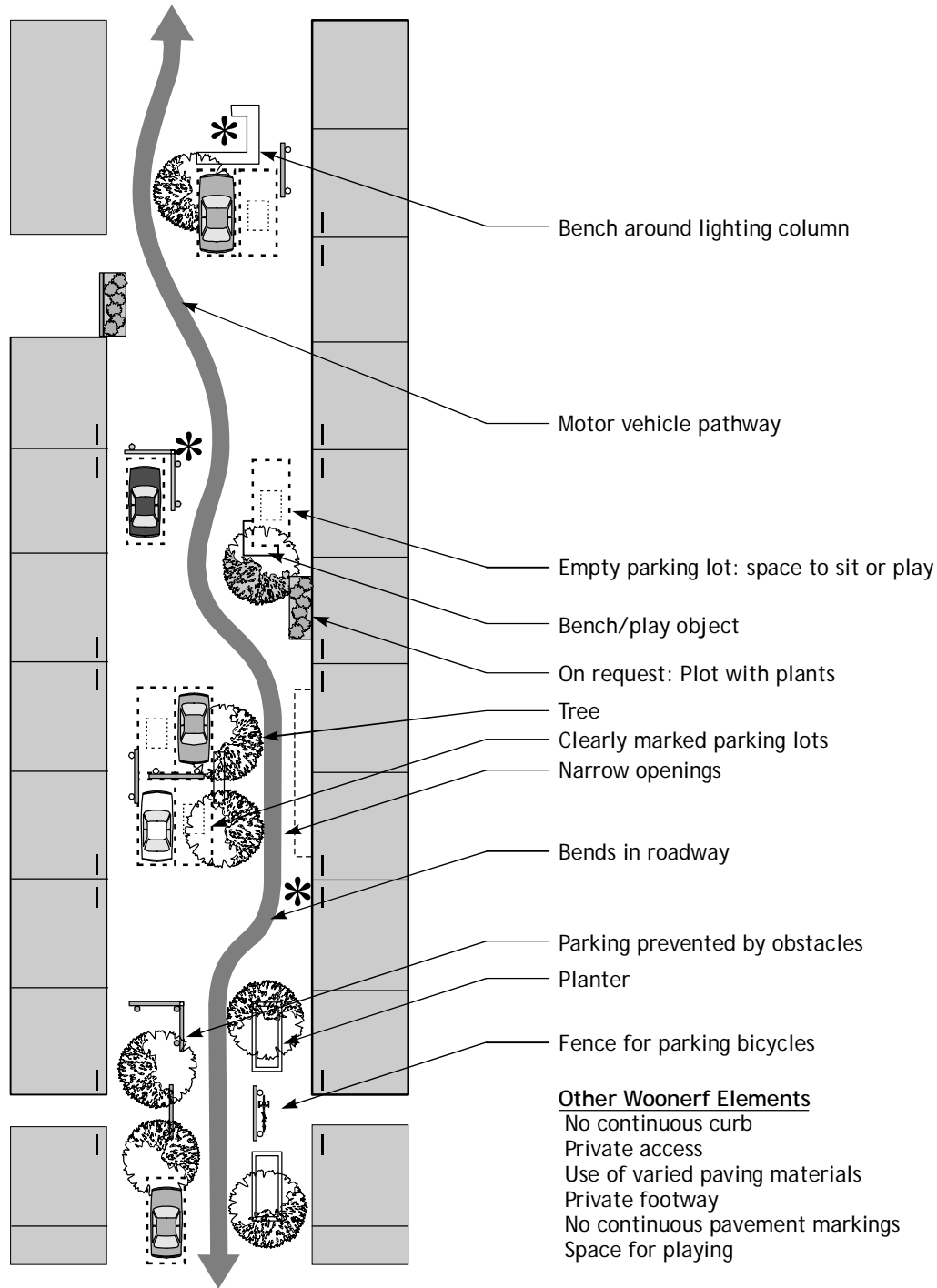

Figure 20-19. Illustration. Model of a woonerf.

The woonerven were closely evaluated, with the following findings:

- Injury crashes were reduced by 50 percent.
- Vehicle speeds were reduced to an average of 13 to 25 km/h (8 to 15 mi/h).

- Nationally, 70 percent of the Dutch population thought woonerven to be attractive or highly attractive.
- Nonmotorized users assessed woonerven more positively than motorized users.
- Feedback from residents living on woonerven was very positive. They appreciated the low traffic volumes and absence of cut-through traffic, but considered the larger play areas and other improvements to the street environment to be even more important benefits.

Woonerf Design Principles

Following evaluation of the woonerven, the Dutch law was amended (July 1988) to allow greater design flexibility and replaced the design rules with six basic principles.

1. The main function of the woonerf shall be for residential purposes. Thus, roads within the “erf” area may only be geared to traffic terminating or originating from it. The intensity of traffic should not conflict with the character of the woonerf in practical terms: conditions should be optimal for walking, playing, shopping, etc. Motorists are guests. Within woonerven, traffic flows below 100 vehicles per hour should be maintained.
2. To slow traffic, the nature and condition of the roads and road segment must stress the need to drive slowly. Particular speed-reduction features are no longer mandated, so planners can utilize the most effective and appropriate facilities.
3. The entrances and exits of woonerven shall be recognizable as such from their construction. They may be located at an intersection with a major road (preferable) or at least 20 m (60 ft) from such an intersection.
4. The impression shall not be created that the road is divided into a roadway and sidewalk (see figure 20-20). Therefore, there shall be no continuous height differences in the cross-section of a road within a woonerf. Provided this condition is met, a facility for pedestrians may be realized. Thus, space can be designated for pedestrians and a measure of protection offered, for example, by use of bollards or trees.
5. The area of the road surface intended for parking one or more vehicles shall be marked at least at the corners. The marking and the letter “P” shall be clearly distinguishable from the rest of the road surface. In shopping street “erfs” (winkelerven), special loading spaces can be provided, as can short-term parking with time limits.
6. Informational signs may be placed under the international “erf” traffic sign to denote which type of “erf” is present.



Figure 20-20. Photo. The distinctions between sidewalks and roadways are blurred in woonerfs.

Entry Treatment Across Intersections

Traffic-calming devices can be combined to provide an entry or gateway into a neighborhood or other district, reducing speed through both physical and psychological means. Surface alterations at intersections with local streets can include textured paving, pavement inserts, or concrete, brick, or stone materials. At the entry, the surface treatment can be raised as high as the level of the adjoining curb. Visual and tactile cues let people know that they are entering an area where motor vehicles are restricted.

Eugene, OR, installs curb extensions at entrances to neighborhood areas, usually where a residential street intersects an arterial. The curb extension is placed to prevent motor vehicle traffic from cutting through the neighborhood. The curb extension is signed as a neighborhood entrance or exit. Most of the street remains two-way, but one end becomes a one-way street. Compliance by motor vehicles is mostly good. Bikes are allowed to travel both ways at all curb extensions.

Bicycle Boulevards

The City of Palo Alto, CA, has moved beyond spot traffic-calming treatments and has created bicycle boulevards—streets on which bicycles have priority.

The purpose of a bicycle boulevard is to provide:

- Throughways where bicycle movements have precedence over automobiles.
- Direct routes that reduce travel time for bicyclists.

- Safe travel routes that reduce conflicts between bicyclists and motor vehicles.
- Facilities that promote and facilitate the use of bicycles as an alternative transportation mode for all purposes of travel.

The Palo Alto, CA, bicycle boulevard is a 2-mi stretch of Bryant Street, a residential street that runs parallel to a busy collector arterial. It was created in 1982 when barriers were fitted to restrict or prohibit through motor vehicle traffic, but to allow through bicycle traffic. In addition, a number of stop signs along the boulevard were removed. An evaluation after 6 months showed a reduction in the amount of motor vehicle traffic, a nearly twofold increase in bicycle traffic, and a slight reduction in bicycle traffic on nearby streets.

The City also found that anticipated problems failed to materialize and concluded that a predominantly stop-free bikeway—on less traveled residential streets—can be an attractive and effective route for bicyclists. The bicycle boulevard bike traffic increased to amounts similar to those found on other established bike routes.

The bicycle boulevard continues to function as a normal local city street, providing access to residences, on-street parking, and unrestricted local travel. The City received complaints about the visual appearance of the initial street closure barriers (since upgraded with landscaping), but is unaware of any other serious concerns of nearby residents.

Plans for the extension of the bicycle boulevard through downtown Palo Alto, CA, were approved by the City Council in the summer of 1992. Included in this extension was the installation of a traffic signal to help bicyclists cross a busy arterial.

Channelization Changes

The Seattle Engineering Department is changing some of Seattle, WA, streets from four lanes to two lanes with a center left-turn lane. These channelization changes can provide extra room for bicycle lanes or a wide lane for cars and bikes to share (see figure 20-21).

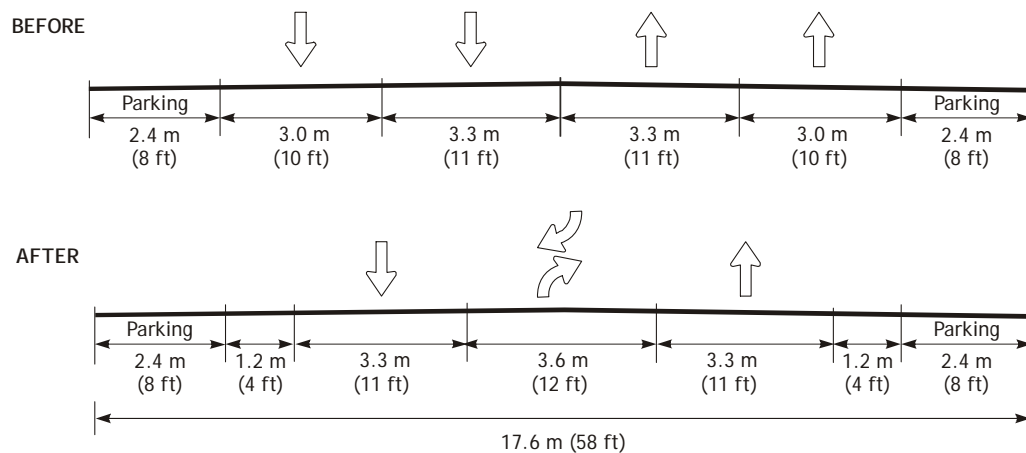

Figure 20-21. Illustration. The conversion of a four-lane roadway—the elimination of one travel lane in each direction creates space for bicyclists.

Numerous comments from users of some of those streets say motor vehicle speeds seem to have decreased. One street in particular, Dexter Avenue North, is a popular commuting route to downtown Seattle, WA, for bicyclists.

Traffic counts on the street show bicyclists make up about 10 to 15 percent of the traffic at certain times during the day. The rechannelization had little or no effect on capacity, reduced overtaking crashes, and made it easier for pedestrians to cross the street (by providing a refuge in the center of the road).

20.7 Student Exercise

Do one of the following exercises:

1. Choose a site-specific location (such as two to three blocks of a local street) where fast traffic or shortcuts are a problem. Conduct a site analysis to determine problems. Prepare a detailed site solution that incorporates several traffic-calming devices. Illustrate with drawings and describe the anticipated changes in traffic speed.
2. Prepare a traffic-calming solution for an entire neighborhood or downtown area that illustrates an area-wide approach to slowing traffic. Conduct a site analysis to determine problem areas. Illustrate your solutions and describe the anticipated changes in traffic speed and flow.

20.8 References and Additional Resources

The references for this lesson are:

1. *Traffic Calming: State of the Practice*, ITE with FHWA, Publication No. FHWA-RD-99-135, McLean, VA, August 1999, available online at <http://www.ite.org/traffic/tcstate.htm#tcsop>, accessed April 22, 2004.
2. *Roundabouts: An Informational Guide*, FHWA, Publication No. FHWA-RD-00-067, McLean, VA, June 2000, available online at <http://www.tfhrc.gov/safety/00-0671.pdf>, accessed April 22, 2004.
3. *Modern Roundabouts for Oregon*, Publication No. OR-RD-98-17, Oregon Department of Transportation, June 1998, available online at http://www.oregon.gov/ODOT/TD/TP_RES/docs/Reports/ModernRoundAbout.pdf, accessed April 22, 2004.
4. Hass-Klau, C., *Illustrated Guide to Traffic Calming*, Friends of the Earth, London, UK, 1990.

Additional resources for this lesson include:

- “Case Study No. 19: Traffic Calming, Auto-Restricted Zones, and Other Traffic Management Techniques—Their Effects on Bicycling and Pedestrians,” *National Bicycling and Walking Study*, FHWA, 1994, available online at http://safety.fhwa.dot.gov/ped_bike/docs/case19.pdf, accessed April 22, 2004.
- Drake, B., and D. Burden, *Pedestrian and Bicyclists Safety and Accommodation Participation Workbook*, NHI Course No. 38061, FHWA-HI-96-028, 1996.
- Ewing, R., and C. Kooshian, “U.S. Experience With Traffic Calming,” *ITE Journal*, August 1997, pp. 28–33, available online at <http://tac.arlington.ma.us/references/survJHA97A28.pdf>.
- Hoyle, C., “Traffic Calming,” *Planning Advisory Service Report No. 456*, American Planning Association, 1995.

- *Modern Roundabout Practice in the United States*, NCHRP Synthesis 264, TRB, 1998.
- *Summary of a Proposed Recommended Practice—Guidelines for the Design and Application of Speed Humps*, ITE, 1993, available online at <http://www.ite.org/traffic/documents/JEA93A11.pdf>.

LESSON 21:

BICYCLE AND PEDESTRIAN ACCOMMODATION IN WORK ZONES

21.1 Introduction

When construction zones encroach on sidewalks or crosswalks, pedestrians may suddenly find they have to make detours that are unsafe, difficult to navigate, or both (see figure 21-1). They may be forced to choose between picking their way through the construction site or walking in a busy street. Projects that are built in phases and construction zones that change weekly or even daily only add to the problem.

Bicyclists also experience difficulties when traveling through construction zones, particularly when roadway space is constrained and pavement conditions are rough. In some instances, sudden pavement changes in construction zones can represent a severe hazard to bicyclists. In all such cases, it is important to ensure that bicycle and pedestrian detour routes are accessible and signed for all users.



Figure 21-1. Utility work in bike lanes can often be accomplished without blocking the entire lane.

This lesson describes typical problems and solutions that improve conditions for bicyclists and pedestrians in work zones. The major sections of this lesson are as follows:

- 21.1 Introduction.
- 21.2 Possible Solutions.
- 21.3 Implementation Strategies.
- 21.4 Planning and Design Considerations.
- 21.5 Student Exercise.
- 21.6 References and Additional Resources.

21.2 Possible Solutions

It is important to develop and implement construction zone policies to eliminate unexpected obstacles for pedestrians and bicyclists and make transitions as safe and smooth as possible. The following concerns should be addressed:

- Advance warning and guidance signs.
- Adequate illumination and use of retroreflective materials.
- Channelizing and barricading to separate pedestrians from traffic.
- Temporary curb ramps and pedestrian signals where appropriate.
- Measures preventing visually impaired pedestrians from entering work zones.
- Warnings to bicyclists about surface irregularities and maintenance of areas where bicyclists can pass through construction zones.
- Circumstances requiring temporary walkways and/or bikeways.

Contractors should be allowed flexibility as long as requirements are met. Because many traffic control decisions are made daily in the field, it is often difficult to plan ahead. All parties involved should be made aware of the needs of pedestrians and bicyclists and be made responsible for ensuring safe and continuous passage. Many agencies require contractors to maintain access on the same side of the street.

Protective Barriers

According to the “Safety in Work Zones” chapter of the Georgia Department of Transportation (GDOT) publication, *Pedestrian and Streetscape Guide*:⁽¹⁾

Near work zones where higher volumes of pedestrian traffic or school children exist, pedestrian fences or other protective barriers may be needed to prevent pedestrian access into a construction area. Barriers should be made of sturdy, non-bendable material such as wood. Pedestrian fences should be at least 2.4 m (8 ft) high to discourage pedestrians from climbing over the fence and should be (cane) detectable by vision impaired.

The 2003 MUTCD provides the following standard relating to protective barriers:⁽²⁾

Short intermittent segments of temporary traffic barrier shall not be used because they nullify the containment and redirective capabilities of the temporary traffic barrier, increase the potential for serious injury both to vehicle occupants and pedestrians, and encourage the presence of blunt, leading ends. All upstream leading ends that are present shall be appropriately flared or protected with properly installed and maintained crashworthy cushions. Adjacent temporary traffic barrier segments shall be properly connected in order to provide the overall strength required for the temporary traffic barrier to perform properly.

Covered Walkways

The GDOT *Pedestrian and Streetscape Guide* also states:⁽¹⁾

For construction of structures adjacent to sidewalks, a covered walkway may be required to protect pedestrians from falling debris. Covered walkways should be designed to provide:

- Sturdiness.
- Accessible for all users.
- Adequate light and visibility for nighttime use and safety.
- Proper sight distance at intersections and crosswalks.
- Adequate and impact-resistant longitudinal separation from vehicles on higher speed streets; for work zones adjacent to high speed traffic, wooden railings, chain link fencing, and other similar systems are not acceptable.

The MUTCD standard provides that “temporary traffic control devices used to delineate a temporary traffic control zone pedestrian walkway shall be crashworthy and, when struck by vehicles, present a minimum threat to pedestrians, workers, and occupants of impacting vehicles.”⁽²⁾

Sidewalk Closures

The “Safety in Work Zones” chapter of the GDOT *Pedestrian and Streetscape Guide* provides this information about sidewalk closures:⁽¹⁾

It is undesirable to close sidewalks or pathways during construction. This should be the last option. If sidewalks have to be closed, construction sites should provide alternative pedestrian routes, safe crossings to the other side of the street, and easy-to-read and distinguishable signs and placement markings. Temporary walkways must also be safe and clear of obstructions such as debris, potholes, grade changes, and mud. If a temporary route is created in the roadway adjacent to the closed sidewalk, the parking lane or one travel lane in a multilane street may be used for pedestrian travel, with appropriate barricades, cones, and signing, as illustrated in [f]igure 21-2. When using a barricade, it must be a continuous route, detectable by a cane. When a parking lane or travel lane is not available for closure, pedestrians must be detoured with advance signing in accordance with the MUTCD. For midblock construction, signs should be placed at the nearest intersection to forewarn pedestrians of a sidewalk closure. Signs should also be placed to avoid blocking the path of pedestrians.

If sidewalks are closed and an alternate route has been determined, chapter 6D of MUTCD provides the following guidance for planning for pedestrians in temporary traffic control zones:⁽²⁾

1. Pedestrians should not be led into conflicts with work site vehicles, equipment, and operations.
2. Pedestrians should not be led into conflicts with vehicles moving through or around the work site.
3. Pedestrians should be provided with a safe, convenient path that replicates as nearly as practical the most desirable characteristics of the existing sidewalk(s) or a footpath(s).

Avoid closing the crosswalks at intersections. Also, at signalized intersections:⁽¹⁾

- Mark temporary crosswalks if they are relocated from their previous location.
- Maintain access to pedestrian pushbuttons.
- Include pedestrian phases in temporary signals.
- Place advanced signing at intersections to alert pedestrians of midblock work sites and direct them to alternate routes (consider all users).

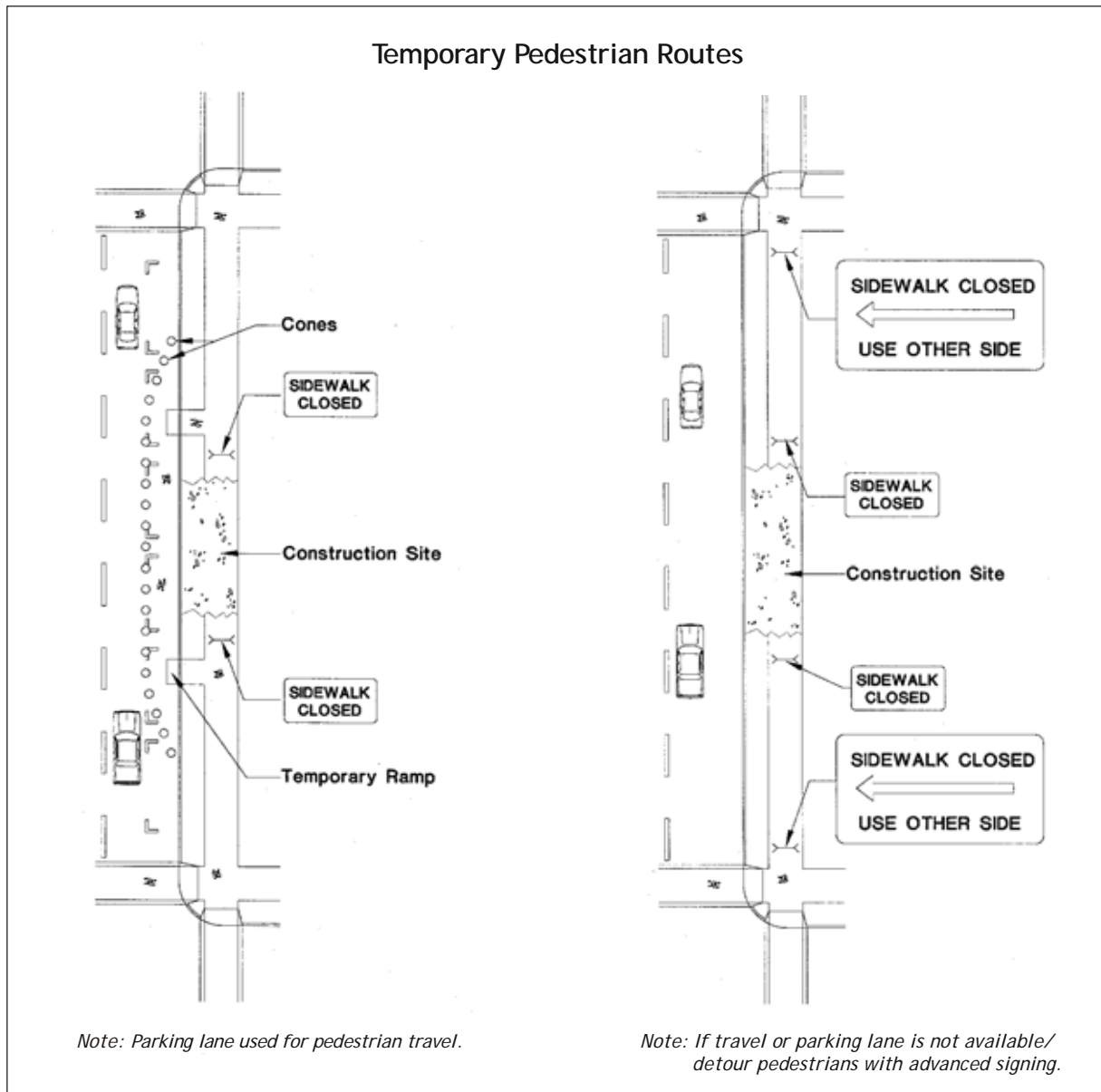

Figure 21-2. Illustration. Example method to create passageways for pedestrians during construction.

Source: *Pedestrian and Streetscape Guide*⁽¹⁾

Signage

Advance signage should be provided that will alert pedestrians to potential sidewalk closures, diversions, or detours. Where pedestrians with vision disabilities normally use the closed sidewalk, a barrier that is detectable by a person aided by a long cane shall be placed across the full width of a closed sidewalk.⁽²⁾

Adequate provisions should be made for persons with disabilities as determined by an engineering study or by engineering judgment. Because printed signs and surface delineation are not usable by pedestrians with visual disabilities, blocked routes, alternate crossings, and sign and signal information should be communicated to such pedestrians with audible information devices, accessible pedestrian signals, and barriers and channelizing devices that are detectable to pedestrians who are aided by a long cane or have low vision.⁽²⁾

The most desirable way to provide visually disabled pedestrians with information that is equivalent to visual signage for notification of sidewalk closures is a speech message provided by an audible information device. Devices that provide speech messages in response to passive pedestrian actuation are the most desirable. Other devices that continuously emit a message or that emit a message in response to use of a pushbutton are also acceptable. Signage information can also be transmitted to personal receivers, but currently such receivers are not likely to be carried or used by pedestrians with visual disabilities in temporary traffic control zones. Audible information devices might not be needed if detectable channelizing devices make an alternate route of travel evident to pedestrians with visual disabilities.

Diversions and Detours

The following standards and guidance are from the 2003 edition of the MUTCD:⁽²⁾

When existing pedestrian facilities are disrupted, closed, or relocated in a temporary traffic control zone, the temporary facilities shall be detectable and include accessibility features consistent with the features present in the existing pedestrian facility.

To accommodate the needs of pedestrians, including those with disabilities, the following considerations should be addressed when temporary pedestrian pathways in temporary traffic control zones are designed or modified:

- Provisions for continuity of accessible paths for pedestrians should be incorporated into the temporary traffic control process. Pedestrians should be provided with a reasonably safe, convenient, and accessible path that replicates as much as practical the desirable characteristics of the existing pedestrian facilities.
- Access to temporary transit stops should be provided.
- Blocked routes, alternate crossings, and sign and signal information should be communicated to pedestrians with visual disabilities by providing devices such as audible information devices, accessible pedestrian signals, or barriers and channelizing devices that are detectable to the pedestrians traveling with the aid of a long cane or who have low vision. Where pedestrian traffic is detoured to a temporary traffic control signal, engineering judgment should be used to determine if pedestrian signals or accessible pedestrian signals should be considered for crossings along an alternate route.

- When channelizing is used to delineate a pedestrian pathway, a continuous detectable edging should be provided throughout the length of the facility such that pedestrians using a long cane can follow it.
- A smooth, continuous hard surface should be provided throughout the entire length of the temporary pedestrian facility. There should be no curbs or abrupt changes in grade or terrain that could cause tripping or be a barrier to wheelchair use. The geometry and alignment of the facility should meet the applicable requirements of the ADAAG (see [s]ection 1A.11).
- The width of the existing pedestrian facility should be provided for the temporary facility if practical. Traffic control devices and other construction materials and features should not intrude into the usable width of the sidewalk, temporary pathway, or other pedestrian facility. When it is not possible to maintain a minimum width of 1500 mm (60 in) throughout the entire length of the pedestrian pathway, a 1500 by 1500 mm (60 [by] 60 in) passing space should be provided at least every 60 m (200 ft), to allow individuals in wheelchairs to pass.
- Signs and other devices mounted lower than 2.1 m (7 ft) above the temporary pedestrian pathway should not project more than 100 mm (4 in) into accessible pedestrian facilities.

See figure 21-3 for an example of a crosswalk closure and pedestrian detour.

21.3 Implementation Strategies

Developing a workable policy for bicycle and pedestrian access through construction zones requires the cooperation of traffic engineers, construction inspectors, crew chiefs, contractors, and advocates. The policy should apply whenever construction or maintenance work affects pedestrian or bicycle access, whether the work is done by private firms or city, county, or State crews.

Link to Construction Permits

To develop the above policy, permits required for street construction or construction projects that encroach upon sidewalks or crosswalks should be contingent upon meeting bicycle and pedestrian access policies. Contractors should be given copies of the standards when they apply for a permit. Preexisting standards or a policy that is readily available will prove useful for incorporation into contracts, agreements, or specifications.

Train In-House Work Crews

Many road, pavement, maintenance, or utility projects use permanent city crews to do the work. Crew chiefs and crews should be educated to ensure that they understand and follow the policy.

Enacting pedestrian and bicycle access policies for work zones are not expensive. The main costs involve developing the policy, training crews and construction inspectors, and imparting information to contractors. Ongoing costs will involve work site inspection.

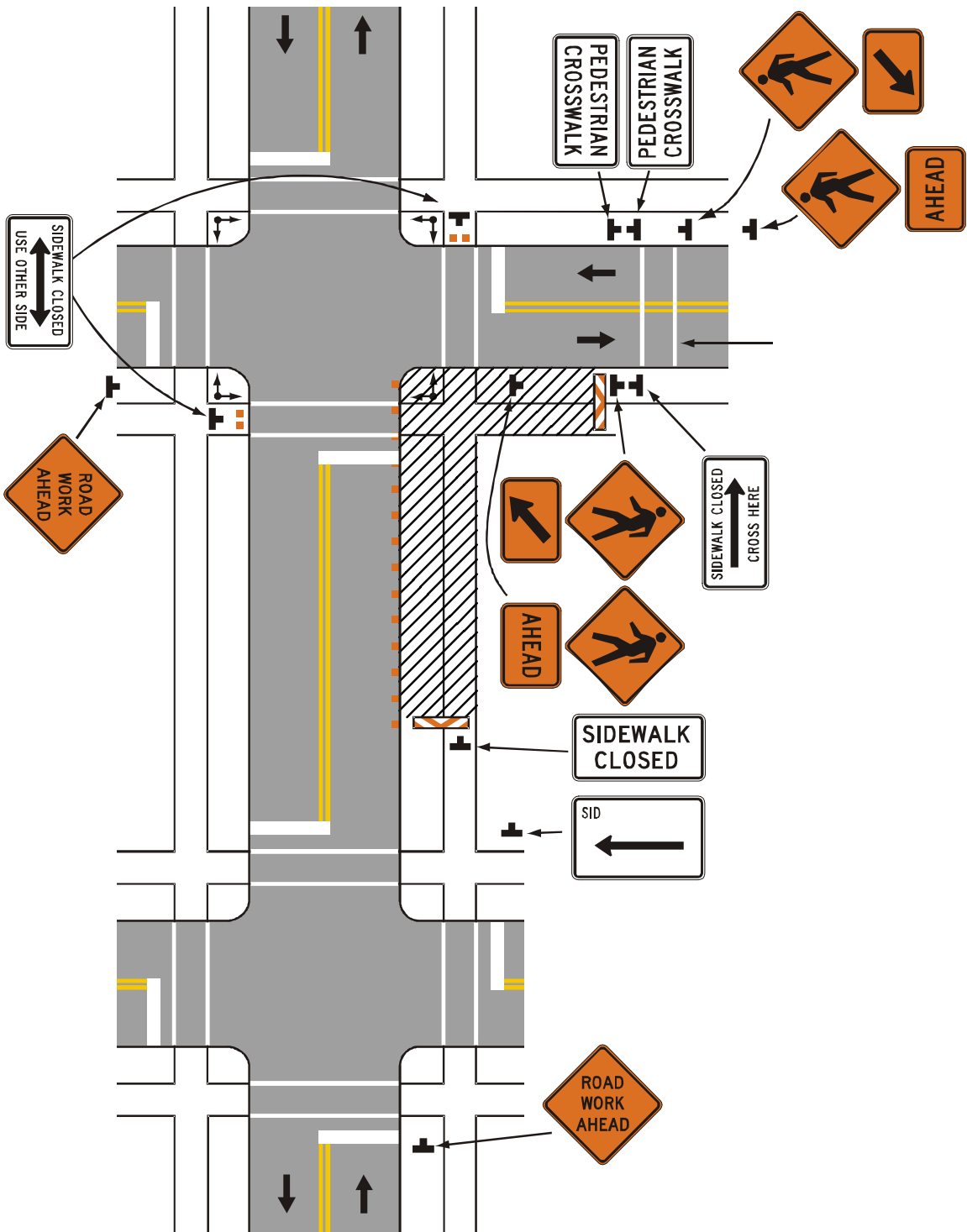

Figure 21-3. Illustration. Sidewalk closure and pedestrian detour example.

Source: MUTCD⁽²⁾

21.4 Planning and Design Considerations

While the 2003 MUTCD pedestrian guidelines apply to pedestrian traffic around work zones, the absence of specific guidance on pedestrian access around construction zones leaves local agencies with a great deal of flexibility. Keep in mind that MUTCD silence on this subject may lead some in an agency to balk at establishing hard and fast regulations.

Rural Highway Construction

Construction operations on rural highways affect mostly touring and recreational bicyclists; pedestrians are seldom encountered in rural settings.

On low-volume roads or through short construction zones, standard traffic control practices are usually adequate. Bicyclists can ride through without impeding traffic. Their needs can be met by maintaining a paved surface and removing temporary signs, debris, and other obstructions from the edge of the roadway after each day's work.

On high-volume roads or through long construction zones, enough paved roadway width should be provided for motor vehicles to safely pass bicyclists. Flaggers and pilot cars should take into account the bicyclists' lower speeds. When bicyclists are coming through, radio messages can be relayed to other flaggers.

On highways with very high traffic volumes and speeds, and where construction will restrict available width for a long time, it may be advisable to provide a detour route for bicyclists where possible. The detour should not be overly circuitous. Directional signs should guide bicyclists along the route and back onto the highway.

Urban Roadway Construction

Through-bicycle movement must also be maintained. Bicyclists can share a lane over a short distance. On longer projects and on busy roadways, a temporary bike lane or wide outside lane may be provided. Bicyclists should not be routed onto sidewalks or onto unpaved shoulders.

Debris should be swept to maintain a reasonably clean riding surface in the outer 1.5 or 1.8 m (5 or 6 ft) of roadway. Bicyclists have a low tolerance for surface grade changes and excessive bumps should be avoided.

The placement of advance construction signs should obstruct neither the pedestrian's nor the bicyclist's path (see figure 21-4). Where this is not possible, placing signs half on the sidewalk and half on the roadway may be the best solution.

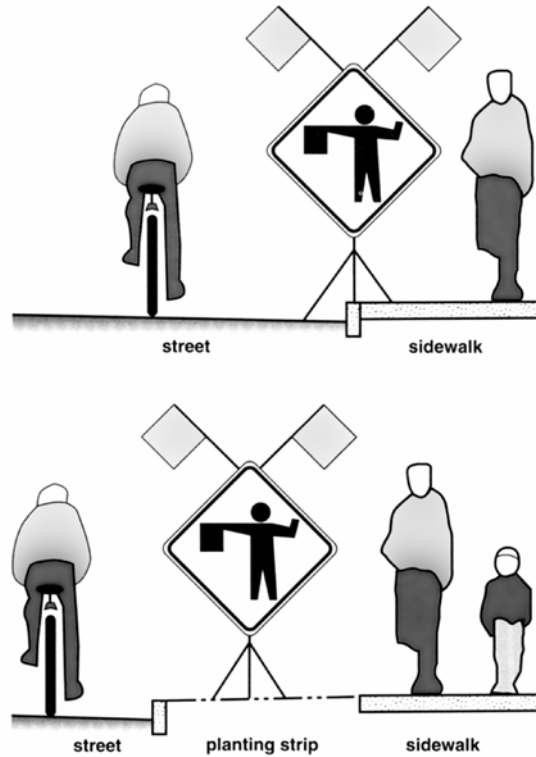

Figure 21-4. Illustration. Construction sign placement.

Pedestrian Issues: Seattle Example

The City of Seattle, WA, has developed specific policies for pedestrian access, control, and protection in work zones. These policies are detailed in the City’s *Traffic Control Manual for In-Street Work*.⁽³⁾ The purpose of the manual is “to set forth the basic principles and standards to be observed by all those who perform work in public streets so as to provide safe and effective work areas and to warn, control, protect, and expedite vehicular and pedestrian traffic.”

Before any in-street work is started, all persons performing work within the street right-of-way must first obtain a permit by submitting and receiving approval of a traffic control plan.

To protect pedestrians, the manual describes procedures for erecting protective barricades, fencing, and bridges, together with guidance devices and signs. Whenever passageways or walkways are affected by construction, access for pedestrians and disabled persons is ensured. Access to recommended school crossings must be maintained at all times. Where walkways are necessarily closed by construction, alternate walkways, including temporary curb ramps, must be provided. Where alternate walkways are not feasible, signs are required at the limits of construction and in advance of the closure at the nearest crosswalk or intersection to divert pedestrians across the street. Pedestrians must never be diverted into a portion of the street concurrently used by moving vehicular traffic. Where required, fixed pedestrian ways using fences and canopies shall be considered. Adequate illumination and use of retroreflective materials are required during hours of darkness.

Figures 21-5 and 21-6 are excerpted from Seattle’s *Traffic Control Manual for In-Street Work*.⁽³⁾

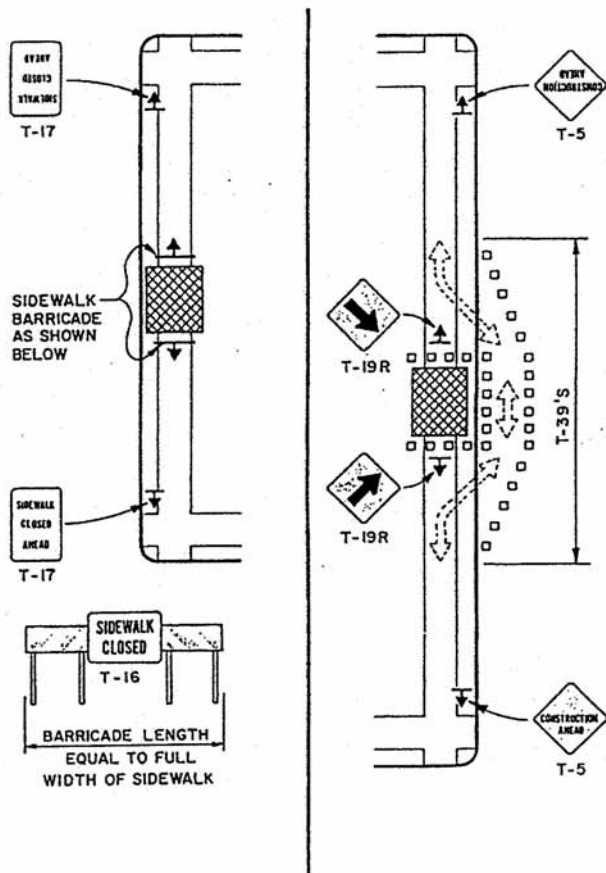
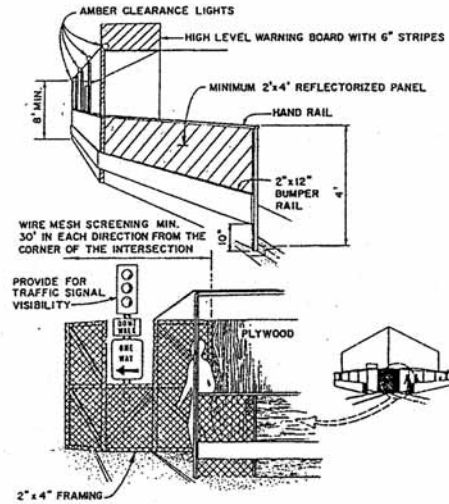

Figure 21-5. Illustration. Pedestrian control.

Source: *Traffic Control Manual for In-Street Work*⁽³⁾



PEDESTRIAN PROTECTION

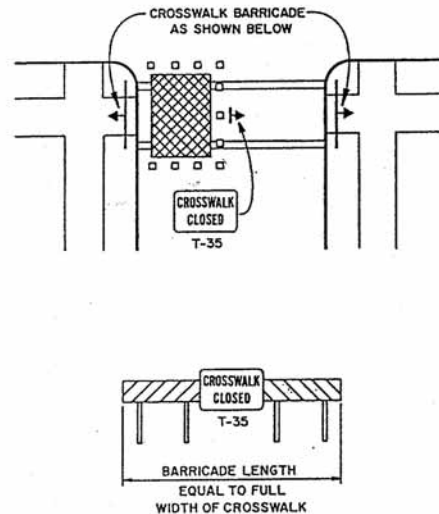

Figure 21-6. Illustration. Pedestrian control.

Source: *Traffic Control Manual for In-Street Work*⁽³⁾

21.5 Student Exercise

Identify several work zone locations and determine what elements of accommodation are being made. Are there others that could be made or might be more appropriate? Survey the location for several hours during the peak traffic period and determine if pedestrians are using the facilities in place. Do they violate the channelization? Why do they violate it, and are they endangering themselves? What can be done to improve the situation?

21.6 References and Additional Resources

The references for this lesson are:

1. “Toolkit 11: Safety in Work Zones,” *Pedestrian and Streetscape Guide*, Georgia Department of Transportation, Atlanta, GA, November 2003, available online at http://www.dot.state.ga.us/DOT/plan-prog/planning/projects/bicycle/ped_facilities_guide/index.shtml, accessed April 23, 2004.
2. MUTCD, USDOT, FHWA, Washington, DC, 2003, available online at <http://mutcd.fhwa.dot.gov>, accessed March 21, 2003.
3. *Traffic Control Manual for In-Street Work*, Fourth Edition, Seattle Department of Transportation, Seattle, WA, 1994, available online at <http://www.seattle.gov/transportation/trafficcontrolmanual.htm>.

Additional resources for this lesson include:

- *Oregon Bicycle and Pedestrian Plan*, Oregon Department of Transportation, Salem, OR, 1995.
- *Implementing Pedestrian Improvements at the Local Level*, USDOT, FHWA, Publication No. FHWA-98-138, Washington DC, 1998, Available online at <http://safety.fhwa.dot.gov/fourthlevel/pdf/LocalPedGuide.pdf>, accessed March 9, 2004.

LESSON 22:

TORT LIABILITY AND RISK MANAGEMENT

22.1 Introduction

This lesson provides an understanding of tort liability, risk management principles, and techniques for monitoring and evaluating existing facilities and programs. Key definitions are provided, along with information on litigation trends, exposure evaluation methodologies, successful risk-reduction strategies, and case study examples. Students will study real cases that illustrate the importance of considering human performance in planning and design and of the role facilities play in creating predictable behavior. An understanding of tort liability and risk management issues will alert the designer to the need for evaluation and monitoring on an ongoing basis and for creating built-in feedback systems. More and more lawsuits are being settled against government entities that adopt a do-nothing posture. Identifying potential risks, doing something, and then evaluating the results as part of a systematic program is proving to be a more defensible approach.

The major sections of this lesson are as follows:

- 22.1 Introduction.
- 22.2 Tort Liability for Bicycle and Pedestrian Facilities.
- 22.3 Trends and Example Cases.
- 22.4 Basic Definitions.
- 22.5 Cases That Lead to Quick Settlements against a Government.
- 22.6 Risk Assessment and Management.
- 22.7 Student Exercise.
- 22.8 References and Additional Resources.

22.2 Tort Liability for Bicycle and Pedestrian Facilities

To an increasing degree, issues of risk management and tort liability are becoming major determinants of planning, engineering, and implementation programs for bicyclists and pedestrians. Agency concerns about potential liability can either lead to innovation and substantially improved facilities and programs, or they can lead to a do-nothing approach. Ignoring risks does not make them go away. Taking systematic steps to identify and evaluate risks and to develop an effective risk management program are essential measures, even if your agency cannot afford to remedy all problems immediately. Without a well-conceived and well-implemented risk management program, the courts become de facto policymakers.

Highway engineers, designers, and planners must consider the needs of the pedestrian and bicyclist. Design of streets, bridges, surface conditions, maintenance, and operations must be all viewed differently with the increasing importance of bicycling and walking to people of all ages. The very young, the old, and the disabled rely on walking and bicycling for everyday transportation and exercise. Highway and recreational facilities that fail to fully incorporate the needs of all users increase the likelihood of potential court settlements in favor of those who are excluded (see figure 22-1). Since most highway professionals are not routinely trained to design for pedestrians and bicyclists, mistakes are common. The result is

increased risk, which is often not identified until crashes occur. Training is especially important since some engineers and planners do not bicycle or walk extensively under the conditions for which they design.



Figure 22-1. Photo. Courts have become less sympathetic to agencies that do not consider the needs of pedestrians and bicyclists.

22.3 Trends and Example Cases

Just how significant is the liability issue? Hasn't this whole thing possibly been exaggerated? How much money is really involved? It has been reported that the total dollar amount of claims against U.S. highway agencies in a typical year is between \$50 and \$60 billion.

The *Urban Transportation Monitor* reported these findings from a 2001 survey of 61 local (e.g., city and county) and State DOTs:⁽¹⁾

- On average, State agencies faced about 80 lawsuits per year. City and county departments faced about three per year.
- About 7 percent of all lawsuits against State agencies required a settlement by the State; however, 50 percent of lawsuits against city and county agencies required a settlement cost.
- The average settlement cost was \$60,000 for State DOTs but \$230,000 for city and county transportation departments.
- The average cost to defend a tort liability lawsuit was about \$70,000, with little practical difference between state costs (\$68,000) and city and county costs (\$72,000).

The United States is experiencing an increase in tort liability claims. The public and its officials can and should demand fairness in settlements; however, it is unlikely that a dramatic reduction in charges and complaints will occur. More lawsuits are being filed. Legal action is becoming broader in its scope, with suits against nonprofits and the families of those affected, as well as agencies and individuals.

Government, well-insured corporations, and professionals continue to be favored targets due, in part, to their perceived deep pockets and ability to pay. There is a tendency toward increased liability in areas that once had some degree of immunity, with a continuing rise in the size of claims.

Insurance companies often settle rather than defend. People with a litigious bent are encouraged by the knowledge that insurance companies often settle quickly rather than bear the time and cost of defending themselves against relatively low-dollar claims. The courts are, in this way, taken out of the process. The knowledge that even a frivolous lawsuit may net someone \$50,000 to \$100,000 provides a strong incentive to sue. In a crazy world, risk management is here to stay. It is important that agencies and organizations understand this fact and structure their actions accordingly.

Planning, Engineering, and Public Perception

Most in the transportation community understand that planning and highway professionals work hard to address traffic problems, improve safety, save money, keep people and goods on the move, and meet many other praiseworthy goals on behalf of the public. But do the public really understand the parameters within which these professionals work? Do the public support their objectives? Do they know the limitations the professionals face—the schedules, budgets, and political pressures? Do they care?

In some cases, it is a struggle to build and maintain the public's confidence in the work of government. It is all too easy to blame mishaps on the bureaucracy and to take them to court if the opportunity arises. When someone travels a roadway or a trail on a regular basis and a crash occurs, they generally look beyond themselves for someone to blame. It is tempting to pin responsibility on the faceless public agency most directly involved in design, maintenance, regulation, or operation of the facility. Not only may people file lawsuits, but also they may become publicly critical of the agency and its programs. They become less likely to endorse budget increases and bond issues. If asked to serve as jurors in tort cases, they recall the negative experiences and perceptions and may filter facts through this bias.

Implementing an aggressive and well-publicized risk management program can help head off these problems. An effective first line of defense is to build and maintain public confidence; to protect budget allocations for needed public works projects; and to foster a spirit of cooperation, not confrontation, between public and private sector parties.

Today, the newspapers and electronic news media frequently headline court settlements against public agencies that have allegedly failed to use good judgment or carry out their professional responsibility on behalf of public health, safety, and welfare. Some settlements now soar as high as \$10 to \$14 million for a single injury. Even minor lawsuits (which may be settled for as little as \$5,000) may require \$10,000 to defend.

Governments Can Be Sued for What They Do

The examples that follow illustrate conditions that can lead to pedestrian and bicyclist injury. In these first two cases, the government was sued for an injury to a pedestrian or bicyclist on a facility that was specifically built to accommodate bicycling and walking.

Example Case 1. An attorney was riding a bicycle on a sidewalk that was previously marked as a bicycle path. He did not slow down when approaching a residential driveway on a semiblind corner. He ran into a motorist exiting the driveway, hitting the car in the middle of the front-door panel. The bicyclist sued the motorist and the condominium owners for \$750,000.

The bicyclist will have a tough time proving that he was not guilty of contributory negligence in this case. Since he hit the middle of the car, it can be argued that he had plenty of discovery time, had he been paying attention and riding in a reasonable and prudent manner. The car was moving very slowly, stopping to check for traffic and entering the street. The bicyclist's view of the driveway was partially blocked by a perimeter wall around the condo complex.

Signing any sidewalk as a bicycle path increases the likelihood of tort settlements even years later. Designating a sidewalk for bicycle use sends the message that it is safe to ride there. Sidewalk facilities have built-in traps for the unsuspecting.

Sight-distance problems at intersections with streets, driveways, and alleys are common on sidewalk facilities. Most local zoning ordinances allow construction of rear and side yard walls to a height of 1.8 m (6 ft) on the rear and side property lines. Since sidewalks are often located very close to rear or side property lines, especially in residential areas, walls on these property lines seriously limit sidewalk views for intersecting motorists.

Motorists expect pedestrians on sidewalks, not bicycles moving 10 times as fast. Bicyclists, with the wind in their ears, on two-wheeled vehicles, are not as sensitive to noise cues as pedestrians and not as maneuverable. It takes them much longer to react and stop.

Since sidewalks have historically been regarded as pedestrian zones, the pedestrian movement pattern of two-way traffic prevails. Bicyclists using the sidewalk often think this applies to them too, and ride against traffic. They don't see stop signs at cross streets (located to be seen by motorists on the other side of the street), and they are not part of the normal scanning pattern for motorists.

A person waiting to turn right will scan to the left for oncoming traffic, wait, and then move quickly to take advantage of a gap. At first, he may take a quick look right to see if a pedestrian is coming, but he seldom looks back. A fast-moving bicyclist can easily escape detection and a crash can result. For these and other reasons, sidewalks are not recommended for designation as bicycle facilities.

Example Case 2. A wheelchair user is traveling along a sidewalk. The sidewalk is discontinuous, with an unpaved stretch of about 45 m (150 ft). To get around this, the wheelchair user moves into the street, going against traffic, gets stuck in sand on the shoulder of the road, and falls over. He can't get up until a passer-by helps him, setting him upright, and pushing him through 45 m (150 ft) of sand to the continuation of the paved sidewalk. The wheelchair is damaged and the person is injured. The pedestrian sues the city, claiming negligence, and wins.

The lesson learned here is to consider all users. Examine your community for these sorts of hazards and institute an aggressive retrofit program. The city was said to have led the wheelchair-bound person into a trap. A continuous paved surface should be provided or warning sign posted well in advance.

Governments Can Be Sued for What They Do Not Do

Doing nothing is not a viable option. In the two examples that follow, injuries occurred because a government did not take action to correct a potentially hazardous situation. More and more governments are being sued for failing to recognize public needs and taking actions to meet them.

Example Case 3. A pedestrian is walking along the sidewalk on a one-way street, facing the flow of traffic approaching a signalized intersection. Because the traffic signals are positioned to be seen by oncoming (one-way) motor traffic, the pedestrian can see neither the motor vehicle signal nor the pedestrian signal (i.e., WALK & DON'T WALK indications). He hesitates until he thinks he has a green

light and then steps out into traffic. After getting partway across, he realizes that he has made a mistake, turns around suddenly, is hit, and injured. The pedestrian sues the city and wins. The city did not provide pedestrian-oriented traffic controls.

The lesson learned in this case is to consider all users. Examine your community for these sorts of omissions and institute an aggressive retrofit program.

Example Case 4. On a bridge that provides the main linkage to downtown, the surface is badly broken up, the pavement has deteriorated on the decking, and seams have been patched over, leaving dangerous ridges (see figure 22-2). This bridge is known to be heavily used by bicycles, and the city has written to the State three times asking that the bridge be repaired due to the potential hazard. Because of these and other hazards, bicyclists cannot ride too near the curb and crowd the motorists in narrow lanes. The State has not responded, despite repeated requests for action.



Figure 22-2. Photo. Bridges are a recurring theme in many tort liability claims.

A semi-tractor-trailer left his air brake on. As he approached the bridge, he released his foot, activating the brake, which caused a loud noise. A 23-year-old woman bicycling across the bridge heard the noise behind her and moved closer to the curb. The trucker once again activated the brake, causing another loud noise as he approached the bicyclist. The bicyclist panicked, rode into the curb, fell, and was killed by the truck. The bicyclist's family and the truck driver's insurance company both sued the State.

Because of the letter written by the city and the length of time the condition had been present, the State settled out of court. In addition to the poor pavement conditions, it was found that the bridge sloped slightly to the right and the State had, over time, let the centerline of the roadway drift toward the right. The right-hand lane was 4.0 m (13 ft) wide, while the left-hand lane width was 5.2 m (17 ft). The bicyclist was forced to share a dangerously narrow lane with both hazardous pavement conditions and heavy truck traffic. The lesson here is to take action promptly in response to identification of hazards, even if it means only the interim measure of posting warning signs until the correction can be made.

The Impact of These Trends

The issue of risk management is becoming a major factor in decisions about implementation of capital projects and programs. The high costs associated with risk management have, in some cases, meant that things simply are not built or programs are not funded. Decisionmakers are becoming gun-shy. Ignoring the problem, however, does not make it go away. As stated earlier, governments are just as often sued for what they do not do as for the actions they do take.

The best approach is to develop a strong, proactive program to plan, design, build, maintain, and operate a fully balanced transportation system that responds to the needs of all potential users (see figure 22-3). The program must be based on a diligently applied set of defensible standards and a public process that allows involvement by all affected parties. It is very important that an agency be able to demonstrate it is aware of potential problems and is taking systematic steps to address them.



Figure 22-3. Photo. The needs of all users, young and old, should be considered in transportation planning and design.

22.4 Basic Definitions

To negotiate the legal minefields successfully, a basic knowledge of several terms is useful. This section defines and provides examples for concepts such as tort, proximate cause, negligence, and sovereign immunity.

Tort

A tort is defined as a wrongful act, not including breach of contract or trust, that results in injury to another person's property or the like and for which the injured party is entitled to compensation. When an individual is harmed by another party without criminal intent, he or she may be able to file a tort claim. The tort claim must be based on establishing that the party had a duty to perform relative to the injured individual and that this duty was not performed with ordinary care, in a reasonable and prudent manner. An injury resulting from a breach of contract or trust does not fall within the definition of a tort.

Example Case 5: A 32-year-old mother of three was permanently disabled when she lost control of her bicycle, went off a multiuse path into a drainage ditch, and fell. Her back was severely injured when she struck a rock on the far side of the ditch.

It was found that the bicyclist was not warned of the potential hazard and thus was surprised by it. Once she went off the path, there was a trap in the recovery area. The assumption that design for low-speed use only was acceptable was found to be invalid. The city was responsible to design for expected speeds and could have been found at fault in this case.

How could the path have been designed to minimize the chances of this type of crash? The path was originally designed as a pedestrian walkway and later designated as a bike path without modifying it to bring it into conformance with AASHTO or other accepted design standards for multiuse facilities.⁽²⁾ When it was built, the path met current standards for pedestrian use. The cost of rebuilding it to accommodate bicycles was thought to be excessive by the city council and signs were simply added to the existing path.

The rationale for this action was that the path was meant for recreational use and that improving it to AASHTO standards would encourage high-speed bicycling that would endanger pedestrians. It was thought that the narrow width and tight turns would force bicyclists to ride slowly and use caution.

The woman injured in the crash approached the turn in the path at a reasonable speed. Her view of the ditch was blocked by tall shrubs at the edge of the path. The horizontal radius of curvature for the path was far below AASHTO standards for a reasonable design speed. The path was designed for a maximum speed of 18 km/h (11 mi/h), whereas AASHTO recommends a 30-km/h (20-mi/h) design speed on level terrain with 38 m (125 ft) of stopping sight distance.⁽²⁾

The edge of the path dropped off directly into a culvert, with no shoulder provided. Swinging a little wide on the turn and having no available recovery area, her tire dropped off the edge of the path into the culvert, and her bicycle flipped, sending her flying to the far side of the drainage ditch.

If the substandard radius on the curve had not caused a loss of control, and if the bicyclist had been able to see how tight the curve would become, and if the culvert had not been in the curve alignment, then the crash might not have occurred. The substandard design, then, is viewed as the proximate cause of the injury. Proximate cause must be proven to establish negligence in court.

The city maintained that it was not designing for the high-speed bicyclist, but for the novice recreational rider who would not go fast. The courts found this position to have contributed to the cause of the crash. This contributory negligence often results in rulings against settlements favorable to the defense.

How could the path have been designed to minimize the chances of this type of crash? Designers need to anticipate use by all types and ages of travelers—motorists, pedestrians, bicyclists; young, old, disabled, or hale and hearty. Only by understanding pedestrian and bicyclist behavior, perceptions, and operations as well as most traffic engineers understand motorists can these problems be avoided in the future.

Negligence

Negligence is defined as an act or omission within the scope of the duties of an individual, agency, or organization that leads to the harm of a person or of the public, as well as the failure to use reasonable care in one's actions. To demonstrate design negligence, the plaintiff's attorney must be able to answer these basic questions:

- Was there a potentially dangerous defect?
- Was a defect a proximate cause of the crash?
- Was there contributory negligence on the part of the bicyclist or pedestrian?
- Did the agency have knowledge that the condition existed?
- Were the agency's actions discretionary or ministerial?

How is a judgment of negligence against government won? It is not easy to prove negligence within the context of the five conditions specified above. However, negligence must be proven if a judgment is to be won. The example that follows is taken from an actual case where negligence was alleged.

Example Case 6. The Florida DOT (FDOT) was charged and tried in a civil court for negligence as a result of a bicyclist falling on a bridge (*Miller v. FDOT*). The bicyclist's wheel fell into a bridge counterweight slot. The rider was pitched forward, sustaining serious facial injuries on the grating. The rider was a professional model and an experienced bicyclist. She brought a tort charge against the State, which had to be defended.

The bridge was built more than 30 years ago, before bicycling became popular. There was no designated bicycle facility on the bridge. The bicyclist was riding to the far left of the lane. Was this a legal location for the bicyclist? Was this position within a narrow lane a logical location? Did the bicyclist have sufficient discovery time to see and avoid the slot? Could an adult with eight years of bicycling experience, one who served as a ride leader and had ridden this route a dozen times previously, have anticipated this danger? Considering your answers to these questions, can the five conditions necessary for negligence be proven?

In this case, the court ruled against FDOT and the case was settled for \$250,000. It was argued that FDOT was negligent for the following reasons:

- FDOT had a duty to design, operate, and provide maintenance services for the bridge. The open counterweight slot constituted a maintenance condition. The government had a duty to maintain and operate a safe road for all users. Furthermore, FDOT had a duty to warn the public of an unsafe condition and had failed to do so. It was argued that the agency knew that bicyclists used this bridge and that there had been previous bicycling crashes on this grating that were associated with this slot.
- The open slot had been previously reported as needing correction, but the correction had not been made. It was argued, therefore, that FDOT had not carried out its duty in a responsible manner. Even though the correction had not been made, FDOT could have warned bicyclists of a potential hazard.
- The slot was the proximate cause of the crash. The bicycle wheel fell through the slot and precipitated the crash.
- The bicyclist may have significantly contributed to the crash (been guilty of contributory negligence) because: (a) she was riding in both an illegal and illogical place on the roadway; (b) she was riding too fast for bridge conditions; (c) she rode this route at least weekly and should have been aware of the hazard; (d) she was riding directly behind another bicyclist so she did not see the slot until it was too late to take evasive action; and (e) she was an expert bicyclist with eight years of experience who served as a ride leader and officer in a bicycle club that used this route weekly; as a leader, she had a responsibility to know and alert others to potential hazardous conditions along the route.

- The bicyclist, a professional model, suffered severe facial damage. The damage claims were found to be real and significant. A \$250,000 settlement was awarded.

Ordinary Care

Ordinary care is defined as the level of care that a reasonably experienced and prudent professional or other individual would have taken in the same or a similar event or action. Ordinary care is distinguished legally from extraordinary care, which parties are not expected to meet. Standards for separating ordinary from extraordinary are based on the expectation that 85 percent of travelers operate in a responsible manner (the 85th percentile rule). Highway professionals are charged to design, operate, and maintain highways for the reasonably prudent traveler.

Example Case 7. In a private development, a bicyclist transporting a child crashed into a second bicyclist, also transporting a child. One bicyclist was approaching a blind corner leading into an underpass from a lateral path providing street access to a greenbelt path. Because of limited clearances within the underpass, the bicyclist rode toward the middle of the underpass. He did not see the other bicyclist (approaching through the underpass from the opposite direction) in time to avoid a crash.

The case was settled against the private developer. It was argued in court that motorists on the bridge above were given the advantage of full design, signing, and operations treatments based on AASHTO standards, but the bicyclists in the underpass below were left to “fend for themselves” in an abandonment of design principles. In this case, the project designer did not offer the same level of care for the bicyclist and pedestrian as was offered to the motorist. This case demonstrates the principle that the needs of all potential users must be given equal weight.

Sovereign Immunity

Immunity is defined as legal protection from court settlements. Sovereign immunity indicates that an agency is not required to pay settlements. Partial immunity puts a cap on how much can be awarded or limits exposure to certain areas, such as maintenance and operations.

Today, most States and some counties have limited immunity. Florida, as an example, has a maximum settlement amount of \$250,000 per incident. If the courts award a settlement in excess of this amount, the plaintiff has to appeal before the legislature for the difference. Very few States still have full sovereign immunity, where a plaintiff must request a waiver to win a government settlement. Some States allow lawsuits, but specify that they must be filed within a short period of time following the injury or limit the amount of the suit. Consultants and corporations have no immunity. Nonprofit corporations are losing the immunity they once had. Individuals seldom have immunity.

To date, few lawsuits have been won against the Federal Government, although many suits are filed. An example of this type of case is *Coleman v. U.S.A.*, in which the National Park Service was sued for a bicycle crash that occurred when a bicyclist crossed the centerline of a roadway to pass other riders during a large, mass bicycle ride. In moving left to pass, he hit a concrete seam along the center of the road at an oblique angle. His wheel caught the seam and he went down. Although this case is still pending, the National Park Service is saddled with the expense of a defense.

Design decisions may have protection, but maintenance and operations do not. Certain actions have full or partial immunity from legal action. As a general rule, governments still enjoy some immunity in the area of design, although this, too, is eroding. There is little immunity for actions related to operations or maintenance. Lawsuits relating to signing, warnings, surface conditions, poor maintenance, and similar factors are among the most difficult cases to defend.

Example Case 8. A well-educated adult bicyclist, riding in the correct direction on a bicycle lane, suddenly swerved left into the traffic lane, where he was hit broadside by a car going 88 km/h (55 mi/h). He was thrown 36 m (120 ft), landed on his head, and sustained severe brain injuries. In this case (*Boyd v. Illinois*), the lawsuit was filed against the bicycle manufacturer and the construction company, since the State of Illinois refused liability under legislative immunity.

In this case, the bicycle lanes are on a highway bordered by steep cliffs on one side and a river on the other. On the river side of the highway, maintenance of the lane is so poor that many bicyclists opt to ride against traffic, along the cliffside lane, where the surface is in much better condition. They prefer to take their chances with oncoming traffic rather than risk a fall from broken pavement and the ever-present gravel, dirt, and debris along the river. The cliffside bicycle lane is routed within the narrow zone between curb and motorway. This zone traps a 0.6- to 0.9-m (2- to 3-ft) wide pile of debris and sediment, especially after storms, leaving a perilously narrow strip for bicycle movements. The bicyclist in the example lost control when a wrong-way cyclist suddenly challenged him for his narrow portion of the lane.

Poor design (curbing and low-grade surfacing and construction quality) in this case led to a poor maintenance condition on both sides of the highway. The extremely poor maintenance on the river side led to an operations problem when bicyclists routinely elected to ride against traffic to maintain their stability rather than cope with the dangerously deteriorated pavement along the river.

22.5 Cases That Lead to Quick Settlements against a Government

Now that we have discussed methods for evaluating risk, common design errors, and general ways of strengthening your legal position, it may be useful to look at some of the most common lawsuits—the ones government employees stay up nights worrying about because they are usually settled quickly in favor of the injured party. Some of the most important pitfalls to be avoided are:

- **Open drainage grates in the traveled way.** Lawyers refer to these as “waiting traps.” Much research has been devoted to analysis and design of bicycle-safe, hydraulically efficient drainage grates. Temporary solutions are simple and cost effective. If the grate cannot be replaced immediately, it can be rotated 90 degrees or temporary strips can be welded across it. It can be marked as a potential hazard.
- **Paths that end suddenly at hazardous locations with no transition or escape route provided** (see figure 22-4 for an example). In court, you will hear that these paths “lead the customer into a trap.” All facilities should be ended logically, with a reasonable warning (e.g., “Path Ends”), a transition to an alternative route, and some design precautions taken so the inattentive path user is not launched off a cliff, slammed into a barricade around a blind corner, or otherwise penalized too harshly.



Figure 22-4. Photo. Example of a sidewalk ending at a bridge abutment with no warning or alternative path.

- **Inadequate curve radii.** Many designers are not aware that speed, not vehicle design, is the sole determinant of the proper radius of curvature. A bicycle and car going the same speed, say 30 km/h (20 mi/h), each need a 29-m (95-ft) horizontal radius for turning. If anything, the bicycle needs a slightly wider path in a curve, since bicyclists lean into a turn, taking up slightly more space. Design speeds of 30 km/h (20 mi/h) on flat terrain and 50 km/h (30 mi/h) for grades up to 4 percent are recommended by AASHTO guidelines.
- **Long-term, severe surface irregularities.** The longer that surface irregularities (such as broken pavement, potholes, raveled edges, bumps, seams, and gutter-edge buildup) are left unattended, the greater is the potential exposure and the more difficult it becomes to convince a jury that you did not know the condition existed. The jury will be convinced that the condition was discoverable and you may be found negligent.
- **Poor sight distances.** Like motorists, bicyclists need time to identify and react to potential hazards, such as tight turns, obstructions in the traveled way and intersecting motor vehicles, pedestrians, and other bicyclists. At least 6 seconds of discovery is needed to allow adequate reaction time, mechanical set-up, and braking to a stop. At 32 km/h (20 mi/h), this is a distance of 54 m (176 ft). Walls and vegetation most often block views, but sometimes, sight distances can also be limited by steep hills (cresting sight distance) or curves on steep grades. These problem areas should be identified, with warning signs installed and/or obstructions removed.
- **Roadway design, planning, operation, and maintenance that do not consider bicycle and pedestrian use.** It is no longer acceptable to plan, design, or build roadways that do not fully accommodate use by bicyclists and pedestrians. The bicycle is seeing increased use for transportation and the health benefits of walking are receiving greater attention. More than twenty years of experience have passed in designing for bicycles in the United States, with millions of dollars devoted to research and planning. With every passing year, the courts become less and less sympathetic to agencies that have not understood the message: bicyclists and pedestrians are intended users of the roadway. Transportation staff must be knowledgeable about planning, design, and other aspects of nonmotorized travel. All modes must be taken into account.

- **Bridges and underpasses that are hazardous to bicycles and pedestrians.** Like motorists, bicyclists need to cross bridges to get to some destinations. Bridges are expensive to build and difficult to retrofit for bicycling. Bridges have many surface conditions, maintenance problems, and operations problems that must be dealt with. A facility of any length is only as safe as its weakest link—often the bridge.
- **Poor maintenance of off-street facilities.** Many agencies have been successfully sued when people slip on gravel, sand, grass clippings, standing water, deteriorating pavement, and similar conditions. Bicycles are particularly sensitive to litter, debris, and other materials. An aggressive maintenance program is essential for all designated facilities. Methods for identifying and correcting problems should be developed in a timely manner.
- **Nonstandard traffic control devices.** The MUTCD and similar manuals adopted by many States establish industry standards for installing signs, traffic signals, and pavement markings.⁽³⁾ When traffic control devices conflict with or are not supported by existing standards, the liability is greater. Certainly these standards manuals like the MUTCD cannot address all possible situations or issues; where they do not, it is best to demonstrate that reasonably prudent judgment and engineering principles were used in the absence of specific standards.

22.6 Risk Assessment and Management

The General Process

Given the increasing liability trends discussed earlier, it makes sense to adopt a proactive position. By developing a realistic assessment of the degree to which your agency may be exposed to potential liability problems, you will have taken an important first step toward developing a practical risk-reduction strategy. It is important that this assessment be systematic, that it be keyed to anticipate and counteract a wide range of legal actions, and that it involve all affected public and private parties. The basic steps are as follows:

- Document the scope of your specified duties.
- For each type of duty, prepare a detailed list of the actions involved in carrying it out.
- Do some homework. Research the crashes and lawsuits that have occurred in your community.
- For each action, document or develop a reasonable standard or set of criteria to be followed, taking into account their impact on all potential users.
- Systematically evaluate your present programs and facilities according to the criteria and standards defined for each action.
- Set priorities for action.

This process should provide a good idea of the strong and weak points of your programs and facilities and an overall picture of your level of exposure. By working thoughtfully through a systematic analysis of what it takes to carry out your assigned duties and a realistic assessment of how well programs and facilities measure up to accepted standards, you will probably learn a great deal and establish a strong direction for subsequent development of a practical risk-reduction strategy (please see figure 22-5).



(This picture shows a bicyclist not wearing a helmet. FHWA strongly recommends that all bicyclists wear helmets.)

Figure 22-5. Photo. An assessment of potential liability is the first step toward a proactive position.

Scottsdale, Arizona Case Study

Let's look for a moment at a recent case study from Scottsdale, Arizona, which has historically been a leader in the provision of bicycle facilities. Since the early 1970s, an extensive and popular multiuse pathway system has evolved—a north-south spine through the most populous part of the city. The paths are used by many commuters, but were designed primarily as recreational facilities. They are now 15 to 20 years old. Some portions were built to standards that are now outdated or are more appropriate to pedestrians than to bicyclists. Use of the paths has increased, along with potential conflicts and the diversity of users. There have been crashes and lawsuits filed.

In 1989, Scottsdale voters approved \$214,000 in bond money for bicycle path improvements. This amount was not enough to bring the pathway system into complete conformance with current standards, but it was an important first step. The City commissioned a study to provide the City with a fully justified basis for developing a risk-reducing improvement program within available funding limitations.⁽⁴⁾

Specifically, the study provided:⁽⁴⁾

- Detailed documentation of existing conditions.
- Review of applicable standards and criteria.
- Analysis of existing conditions in the context of these standards.
- Priorities for implementation.
- A recommended action program.

The *Scottsdale Bicycle Path Improvement Study* focused on giving the City a useful tool for reducing risk along its pathway system through a prioritized set of recommended improvement projects.⁽⁴⁾

Is Ignorance Really Bliss?

The comment is sometimes heard that if all these potential hazards are identified, then the agency's liability may increase since the agency can be shown to have been aware of the hazards without correcting them. Are you really less vulnerable if you don't know what the problems are? In a word, the answer is "no." It is not quite as simple as that, but the following is a summary.

What if you don't know about a potentially hazardous condition and an injury occurs? The success of your defense may, in part, depend on how discoverable the condition was. The question is often asked, "Did the agency have time to discover its error?" If a crash happened during the first week this condition existed, there might be a strong defense since there was not sufficient time to discover the error. If two years had gone by before the crash, most courts would rule that there was plenty of time for the agency to discover the condition and correct it.

Sometimes a condition is so patently unfair to the public that an injured party will bring a suit where he or she would normally accept most of the blame. For more than 15 years, bicyclists have been fighting governments that have tried to keep them off of the roadway. If a pedestrian were injured by a bicyclist on a sidewalk, one or both parties might file a case against the government for forcing the bicyclist into a space that does not provide reasonable and prudent sight distances, operational widths, and which now violates many laws, design standards, and accepted practices.

Example Case 9. In the case of *Walden v. Montana*, a bicyclist descending an interstate ramp into Great Falls, MT, was drafting two fellow bicyclists at high speed. At the pinch point, where the guardrail and the lane narrow, the bicyclist came alongside his friend. The friend moved out from the guardrail, forcing the cyclist into the seam separating the travel lane from the ramp lane. The cyclist hit the lateral seam and crashed, landing on his head at more than 56 km/h (35 mi/h). Was Montana responsible for maintaining a concrete/asphalt joint to meet the needs of the bicyclist on an interstate?

This case was tried and the defense won and the verdict was upheld in the State Supreme Court. They determined that the bicyclist contributed significantly to his own injury. The highway department had a serious uncorrectable groundwater problem that made it difficult to maintain a better joint. The joint met AASHTO standards for preventing tire scuffing and vehicle deflection problems at such a location. Signing the specific nature of the hazard for a bicyclist, who would normally stay on the 3-m (10-ft) shoulder, was not required to meet the standard of ordinary care, which requires highway professionals to design, operate, and maintain highways for the reasonably prudent traveler.

What if you have been made aware of a potentially hazardous condition and an injury occurs before you have taken steps to correct the condition? Agencies have a responsibility to fix problems, but the courts tend to favor good will and intent to find solutions, even if some conditions are too expensive to fix immediately. Again, a great deal will depend on the length of time that has passed between identifying the condition and the injury. If it can be shown that a reasonably short period has elapsed and that the agency or other party is taking positive steps toward correcting the condition, the defense position will be improved. For example, if a city conducts a study to identify areas of potential risk along a recreational trail system and does not have sufficient funds to immediately make all corrections indicated by the study, all is not lost.

If a crash occurs, and the city can demonstrate that it has a well-documented program of risk reduction and that it has taken some interim steps (such as warning signs and markings) to alert trail users to potential risk areas, its defense is strengthened. If it has not identified potential risks and taken steps toward risk reduction, the city's defense would be substantially weakened.

Signing a hazardous condition has long been recognized as an important interim treatment for many conditions (see figure 22-6 for an example). Failing to sign a known condition is difficult to defend. Signing and warning offer two types of benefits: first, people are more cautious, so the number of crashes and injuries are reduced; and second, the attempt to alert the public about a potentially hazardous condition generates good will and makes it more difficult for a plaintiff's attorney to argue that the plaintiff was surprised by the condition. Signing should make use of international symbols and follow the standard signing and marking practices found in MUTCD.

What if you have identified a potentially hazardous condition and have taken steps to correct it? What if you have trimmed shrubs that blocked sight distances, widened a tight turn to meet AASHTO standards, and added adequate shoulders to a path and still someone loses control and is injured? Assuming the agency responsible for the path has carried out its duties using ordinary care in a responsible way, it would be more difficult to prove negligence. The burden of responsibility may well shift to the bicyclist or other injured party whose contributory negligence may have led to the crash.

Spot Maintenance and Improvement Programs

Many communities have implemented a special annual fund to attend to pedestrian and bicycling facilities spot improvements. They have asked bicyclists and others to alert them to any poor maintenance conditions (see figure 22-7 for example postcard). This fund and response system allows the cities to respond to a hazardous condition within 48 hours of discovery.



Figure 22-6. Photo. Use of signing to warn motorists and pedestrians of the potential hazard posed by vehicle mirrors on narrow bridge sidewalks.

TYPE:
 Safety Hazard Access Restriction Facility Need

LOCATION:
 Street, landmarks

PROBLEM:
 What is it and why is it a problem?

RECOMMENDATION:
 What should be done about it?

Figure 22-7. Photo. Example of spot improvement postcard used to identify roadway hazards.

Source: *Vermont Bicycle & Pedestrian Coalition*⁽⁵⁾

22.7 Student Exercise

Students should consider the following scenario and formulate answers to the questions:⁽⁶⁾

Several summers ago at a rest area on an interstate highway in the northern United States, a truck driver pulled his 18-wheeler into the truck parking portion of the rest area. The rest area was located on the side of a gently sloping hill. The truck parking area was at the bottom and the car parking area at the top. In between was the structure housing a travel center, vending machines and restrooms. The truck driver used the facilities and got a candy bar from the vending machine.

As he descended the concrete stairs connecting the upper lot with the lower lot, he lost his balance and began to fall. He reached out to grab the handrail but the handrail was lying in the grass adjacent to the stairs. Unable to regain his balance, he tumbled down the stairs and landed on the sidewalk at the base of the stairs and which served the truck parking area. Although stunned and somewhat bruised, fortunately he was not seriously injured and was able to pick himself up. As he walked forward on the sidewalk, he brushed the dirt and debris off of himself and checked out the condition of his clothing and limbs. (He sustained ligament damage to his wrist and chipped bones around his elbow, both of which would have required medical attention. In addition, he severely tore his \$5,000 Australian leather jacket).

At the same time, another large rig had entered the truck parking area. Since the aisle between the sidewalk and the parking stalls was relatively narrow, the truck had to swing toward the sidewalk to get into the stall. As it swung, the outside mirror on the right side of the truck struck the right shoulder area of the truck driver who was walking on the sidewalk, nearly severing the arm from the shoulder. The victim was flown by helicopter to a regional hospital where the arm was reattached. The individual has permanent limitations on the use of his right arm such that he can no longer drive a commercial vehicle. The truck driver has filed against the State highway agency two lawsuits seeking compensation for

damages and injuries received in the incident (for his medical and other bills and for his reduced earning potential due to the arm problems).

The first suit alleges that the highway agency was negligent in its maintenance of the handrail on the stairs. Investigation revealed that because the handrail extended close to the sidewalk along the car parking lot, it was frequently struck by the bumpers of vehicles pulling into the parking stalls along the curb. Because of these frequent collisions, the handrail eventually failed and fell over, ending up in the grass. Two frequent users of the rest area gave deposition testimony that the handrail was lying in the grass for at least three months prior to the incident in question.

The second suit alleges that the truck parking area was negligently designed such that it facilitated vehicle-pedestrian conflicts of the type which occurred. Highway agency records show that the rest area was designed in the late 1960s, when trucks were not as long or wide as they are today. Records indicate that the 1966 AASHTO *Design Standards for Truck Parking Lots at Rest Areas* manual was used to design the parking lot and that the parking area met those standards. Records also revealed that, in 1985, the highway agency became concerned that the larger trucks found on modern highways were having difficulty maneuvering in the lot. The design division prepared plans for a larger truck parking area using space between the rest area and the interstate highway. However, the plans were rejected by the State environmental protection agency because the expanded lot would have adversely affected a wetland adjacent to the existing parking area. Records indicated that highway agency designers explored other options but simply could not feasibly enlarge the truck parking area without damaging the wetland.

Assume that you are a noted transportation consultant specializing in pedestrian safety. The highway agency retains your services to evaluate the circumstances surrounding these allegations. The attorney for the highway agency wants to know whether in your professional opinion the plaintiff has valid cases.

Question 1: Does the plaintiff have a valid case relative to negligent maintenance of the handrail? Why or why not? If your answer is yes, what risk management lessons can be learned from this lawsuit? Your response should be discussed in general terms so it would be useful to any facility manager.

Question 2: Does the plaintiff have a valid case relative to negligent design of the truck parking area? Why or why not? If your answer is yes, what risk management lessons can be learned from this lawsuit. Your response should be discussed in general terms so it would be useful to any facility manager.

22.8 References and Additional Resources

The references for this lesson are:

1. "This Week's Survey Results: Traffic/Highway Tort Liability," *Urban Transportation Monitor*, Burke, VA, July 20, 2001, pp. 8-11.
2. *A Policy on Geometric Design and Highways and Streets*, AASHTO, Washington, DC, 2001.
3. MUTCD, FHWA, revised edition, November 2003, Washington D.C., Available online at <http://mutcd.fhwa.dot.gov/HTM/2003/html-index.htm>, accessed February 25, 2004.
4. Drake, B., *Scottsdale Bicycle Path Improvement Study*, Gruen Associates, Los Angeles, CA and Baker Engineers, 1991.
5. Vermont Bicycle and Pedestrian Coalition, Available online at <http://www.vtbikeped.org>, accessed May 17, 2004.

6. Student Exercise courtesy of Ronald Eck, West Virginia University, Morgantown, WV.

Additional resources for this lesson include:

- Drake, B., and D. Burden, *Pedestrian and Bicyclists Safety and Accommodation Participation Workbook*, NHI Course No. 38061, FHWA-HI-96-028, 1996.
- Glennon, J.C., *Roadway Defects and Tort Liability*, Lawyers & Judges Publishing Company, Tucson, AZ, 1996.
- *Guide for the Development of Bicycle Facilities*, AASHTO, Washington, DC, 1999.
- Lewis, R.M., *Practical Guidelines for Minimizing Tort Liability*, Report CP-K14, Criterion Press, Overland Park, KS, no date.
- *Managing Highway Tort Liability*, NCHRP Synthesis 206, Washington, DC, 1994.
- “Tort Liability of Highway Agencies,” *Selected Studies in Transportation Law: Volume 4*, NCHRP, Washington, DC, 2002.

LESSON 23:

INTERNATIONAL APPROACHES TO BICYCLE AND PEDESTRIAN FACILITY DESIGN

23.1 Introduction

Other countries with higher levels of bicycling and walking are often presented as examples when discussing improvements to bicycling and walking in the United States. Countries with much higher levels of bicycling and walking include those in Europe (such as The Netherlands, Sweden, Denmark, Germany, and the United Kingdom (U.K.)), Australia, and even Canada in some major cities. These countries are considered to have the most similarities with the United States, more so than Asian countries or other developing third world countries. Therefore, this chapter will focus mostly on European experiences with some examples from Australia, Canada, and other similar countries.

The major sections of this lesson are as follows:

- 23.1 Introduction.
- 23.2 Overview of Trends and Issues.
- 23.3 Pedestrian Facilities and Programs.
- 23.4 Bicycle Facilities and Programs.
- 23.5 Student Exercise.
- 23.6 References and Additional Resources.

This lesson has been primarily derived from the FHWA *Study Tour for Pedestrian and Bicyclist Safety in England, Germany, and The Netherlands*, specifically those sections that describe innovative European approaches to bicycle and pedestrian facility design.⁽¹⁾ Other sources of information are listed at the end of the lesson.

23.2 Overview of Trends and Issues

A 2003 article in the *American Journal of Public Health* provides an excellent comparison of bicycling and walking in the United States to European countries.⁽²⁾ The article highlights the large differences between walking and bicycling levels, as well as the trends and relative safety of walking and bicycling in different countries. The article also highlights some of the causes for these differences, and suggests several strategies that can be adopted from examples in The Netherlands and Germany.

The bicycling and walking levels in urban areas in the United States are low compared to many other countries (see figure 23-1). In the United States, only 7 percent of urban travel is made by bicycling or walking. In Canada, that percentage is nearly double at 12 percent. In most European countries, bicycling and walking travel accounts for 25 to 50 percent of all urban travel.

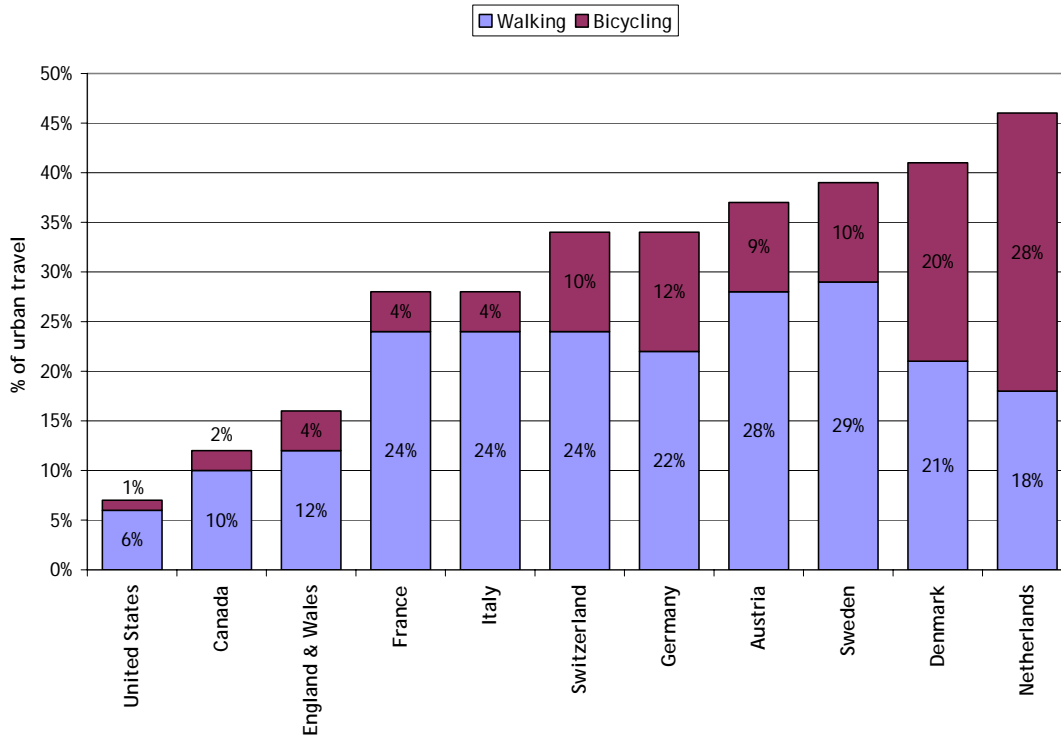

Figure 23-1. Bar chart. Walking and bicycling shares of urban travel in North America and Europe, 1995.

Source: *American Journal of Public Health*⁽²⁾

The authors suggest three primary reasons for the large differences between the United States and the European countries, shown in figure 23-1:⁽²⁾

- More compact land use patterns in European cities lead to average trip distances that are only about half as long as in American cities, and thus, trips there are easier to make with a bicycle or by walking than they are here.
- Higher cost of auto ownership and use (e.g., parking and fuel costs) in Europe means that bicycling and walking trips are often more convenient and less expensive than auto trips.
- Unsafe, unpleasant, and inconvenient conditions in many American cities play a strong role in the lower numbers of bicycle and pedestrian trips here.

Drawing from experiences in The Netherlands and Germany, the authors recommend the following programs and techniques to improve the safety of bicycling and walking in the United States:

- Better facilities for bicycling and walking, such as auto-free zones; wide, well-lit sidewalks; pedestrian refuge islands for crossing wide streets; clearly marked and delineated pedestrian crossings; and extensively connected bicycle lane and path networks.
- Areawide traffic calming of residential neighborhoods, including treatments such as raised intersections and crosswalks, traffic circles, road narrowing, speed humps, and midblock street closures.

- Urban design oriented to people and not cars, which includes mixed-use development, parking lots that are next to or behind buildings (not in front), fewer cul-de-sacs, and easy access to commercial developments by bicycling or walking.
- Restrictions on motor vehicle use, including auto-free zones; dedicated rights-of-way for walking and bicycling; lower speed limits for vehicles in cities; restrictions on parking; and restrictions on truck and through-traffic in residential neighborhoods.
- Traffic education, including more extensive education of motorists, as well as education of school children on safe bicycling and walking practices.
- Traffic regulations and enforcement, including stricter enforcement of speed limits, red light running, crosswalk laws, and bicyclist regulations.

There are clearly several existing cultural and transportation policy differences in the United States that present a challenge to implementing practices from Europe and other countries that have higher levels of bicycling and walking. Several cities in the United States, however, have emulated some European practices. As a result, the levels of bicycling and walking in these cities are much higher than the U.S. national averages.

There are certainly many variations of these strategies listed above that can be effective in the United States. In particular, there are numerous roadway design elements that can make bicycling and walking a safer, more convenient, and reasonable alternative to the auto. In fact, the ITE has published two reports that document innovative pedestrian and bicycle design treatments:

- *Alternative Treatments for At-Grade Pedestrian Crossings.*⁽³⁾
- *Innovative Bicycle Treatments: An Informational Report.*⁽⁴⁾

Many of the innovative treatments in these two reports are located in the U.S. but originate from design treatments or concepts borrowed from other countries.

The remaining sections of this lesson describe different design elements that are frequently used in bicycle and pedestrian-friendly countries.

23.3 Pedestrian Facilities and Programs

Zebra Crossings

Zebra crossings are pedestrian crosswalks at uncontrolled midblock locations (see figure 23-2 for an example from the United Kingdom). The zebra crossings include high-visibility crosswalk markings across the road along with dashed lines that mark the crosswalk at both edges. Belisha beacons (i.e., poles with flashing orange-yellow globes—see figure 23-2) are placed on each side of the crosswalk. At zebra crossings, pedestrians have the right-of-way and drivers must yield (i.e., slow or stop) to pedestrians in the crosswalk. Zebra crossings are preceded by zigzag pavement markings next to the curb on the vehicle approach. However, zebra crossings are considered inappropriate on high-volume or high-speed roads where the 85th-percentile speed is greater than 55 km/h (35mi/h).⁽⁵⁾ Pelican crossings (see later discussion), which use a pedestrian-activated traffic signal to assign right-of-way, are often used at these high-volume or high-speed locations where zebra crossings are inappropriate.



Figure 23-2. Photo. Zebra crossing in London, U.K., with zigzag approach markings and Belisha beacons.

A Swedish study found higher pedestrian-vehicle crash rates at zebra crossings than at signalized intersections or unmarked pedestrian crossings.⁽⁶⁾ The crash rates were greater at zebra crossings even after adjusting for higher pedestrian demand and higher presence of children and the elderly at the zebra crossings. The authors hypothesized that pedestrians were more careful about crossing the street when no additional crosswalk markings are provided. The crash rate comparisons in the Swedish study agree with a U.S. study of marked and unmarked crosswalks.⁽⁷⁾ However, the U.S. study hypothesized that marked crosswalks were only appropriate for certain lower-volume, lower-speed roads. The U.S. study recommended that other treatments (such as median refuge islands, curb extensions, flashing warning lights, traffic calming, etc.) supplement crosswalk markings at high-volume, high-speed crossings.

Pelican Crossings

Pelican crossings (most common in the United Kingdom) are midblock pedestrian crossings controlled by traffic signals and pushbutton pedestrian signals. The pedestrian pushbutton hardware lights up and conveys specific messages to pedestrians during each interval, as shown in figure 23-3. A walking green man symbol and a standing red man are displayed (see figure 23-4). A flashing green man indicates the part of the signal phase for pedestrian clearance. A flashing green man on the pedestrian approach concurrent with flashing amber and red balls on the vehicle approach precedes the green ball indication on the vehicle approach. Instead of zebra crosswalks, pelican crossings have dashed (not solid) parallel lines to mark the crosswalk. As with zebra crossings, pelican crossings are not used at intersections, but are installed only at selected midblock locations.



Figure 23-3. Photo. Pedestrian pushbutton for pelican signals in the United Kingdom.



Figure 23-4. Photo. Pedestrian signal with red standing man (shown) and green walking man.

Toucan Crossings

Toucan crossings (see figure 23-5) are shared crossings for pedestrians and bicyclists (i.e., bicyclists “too can” cross together) at selected crossings at the intersection of roadways with pedestrian and bicycle paths. The preferred layout includes a tactile warning surface, audible beepers, or tactile rotating knobs, pushbuttons with WAIT displayed in each corner of the crossing, infrared lamp monitoring, and vehicle detection on all approaches. The desirable crosswalk width is 4 m (12 ft); the minimum acceptable width is 3 m (10 ft). Signal indications include the standing red man, walking green man, and green bicycle. The flashing amber with the red ball indication is not used for the vehicle approach. Crosswalk lines are delineated by white squares.



*(This picture shows a bicyclist not wearing a helmet.
FHWA strongly recommends that all bicyclists wear helmets.)*

Figure 23-5. Photo. Toucan crossing in the United Kingdom provides separate pedestrian and bicyclist signal indications where trail crosses the road.

*Source: FHWA Study Tour for Pedestrian and Bicyclist Safety
in England, Germany, and The Netherlands⁽¹⁾*

Puffin Crossings

Puffin (pedestrian user-friendly intersection) crossings in the United Kingdom, generally installed at intersections, consist of traffic and pedestrian signals with red pushbutton devices and infrared or pressure mat detectors. After a pedestrian pushes the button (or stands on the mat), a detector verifies the presence of the pedestrian. This helps eliminate false signal calls associated with children playing with the signal button or people who push the button and then decide not to cross. If a pedestrian is present at the end of a vehicle cycle, the red traffic signal is indicated to motorists, and pedestrians see the green man (i.e., WALK display). A separate motion detector extends the green interval (if needed) to ensure that slower pedestrians have time to cross safely. If a pedestrian pushes the button, but fails to wait for the green man symbol, the detector will sense that no pedestrian is waiting and will not stop motor vehicle traffic needlessly.

Puffin crossings are recent developments and are said to improve pedestrian safety and reduce unnecessary vehicle delay. Since the motion detector can detect only those pedestrians walking within the crosswalk lines, physical barriers are used on the curbs to channel pedestrians into the crosswalks. At some crossings, tactile surfaces have been introduced that guide a visually impaired person to the crosswalk. Puffin crossings are currently used at 27 demonstration sites in the United Kingdom. One official stated that they expect to eventually replace all pelican and toucan crossings with puffin crossings if they are found to be effective based on the number of pedestrian crashes, vehicle delays, detector and equipment adequacy, and other factors.

Pedestrian Messages on Pavement

Pedestrian messages, such as “LOOK RIGHT” or “LOOK LEFT” (see figure 23-6), are painted on the street next to the curb to remind pedestrians which direction to look for motor vehicle traffic prior to stepping into the street. These messages are used extensively in London, U.K., where many tourists are accustomed to looking left for traffic before stepping off the curb and looking right for traffic when standing at a pedestrian island in the middle of a two-way street. These pavement messages have also been tested in the United States at places like Salt Lake City, UT where the 2002 Winter Olympics were held.



Figure 23-6. Photo. Pedestrian messages on pavement in London, U.K.

Pedestrian Displays for Traffic Signals

At traffic signals in The Netherlands, pedestrian signal displays include a standing red man (i.e., DON'T WALK) and a walking green man (i.e., WALK). A flashing green man (i.e., you may walk, but the red man display will follow soon) follows the steady green man phase. Pedestrian pushbuttons are also used at some crossing locations. Pedestrian signals are placed at arterial intersections with high volumes of pedestrians and motor vehicles. They are installed near the vehicle traffic signal.

A flashing yellow indicator has been tested in The Netherlands (along with legal regulations) in some simple situations instead of a solid red ball for pedestrian signals. The symbol used for the yellow

indicator is a triangle with an exclamation point inside it. The flashing yellow tells pedestrians that they may cross at their own risk, but other traffic has priority. The zebra crosswalk markings are removed at such locations to avoid suggesting that pedestrians have priority in crossing. The pedestrian green is an exclusive movement and therefore should be conflict-free. The motivations for testing this symbol include the following:

- Whether the pedestrian signal phase is actuated or pretimed, pedestrians are allowed to choose between crossing with the green indication or crossing during the flashing yellow indication during an appropriate gap in traffic.
- Since the red indication is replaced by a flashing yellow, the situation allows for 100-percent compliance by pedestrians. Pedestrians no longer cross against the red indication because there is no longer a red indication.
- At actuated locations, less time is consumed by exclusive pedestrian movements. Since pedestrians know that it is legal to cross whenever they want, they may not bother to call for the pedestrian green.
- The Dutch also state that the use of flashing yellow indicators enhances the status of the red indication. Red indications will only be used at complex crossing locations.

The disadvantages found with the triangle signal include the following:

- It is unknown whether pedestrians understand that they do not have the right-of-way while they are crossing during the flashing yellow indication. However, it appears that turning traffic must give way to pedestrians; therefore, an exclusive turn arrow cannot be combined with a flashing yellow pedestrian indication.
- It is safer for pedestrians to cross with the green indication in conflict-free situations. The situation of crossing during a flashing yellow pedestrian indication is still the same as crossing during a red indication. It is difficult to explain it to children and to convince them that they should wait for the green while they see others crossing at times when the light is yellow or red. Many elderly persons feel safer crossing in groups rather than alone. Following the crowd, an older person may end up at the tail end of the group, exposed to oncoming vehicles, and unable to sprint to safety.

Another device tested in The Netherlands is called a pedestrian sender. This device provides a means for signal preemption for vulnerable pedestrians, including the visually and mobility impaired. The pedestrian sender is similar to the emergency beepers used by the elderly and impaired to call for help. This device influences the traffic controller by doubling the pedestrian green time, activating an acoustic signal, and preventing conflicting traffic movements. No information about providing a directional indication to the vulnerable pedestrian was available. The results of a questionnaire indicated great enthusiasm for the pedestrian sender. The survey also indicated no misuse of the device.

While pedestrian improvements in Delft, The Netherlands, were said to lag behind bicycle facilities, pedestrian signals were installed at selected intersections in that city. A green man, yellow triangle, and red man were used for the WALK, DON'T START (clearance), and DON'T WALK intervals, respectively. Zebra-striped crosswalks are commonly used at pedestrian crossings.

Animated Eyes on Pedestrian Signals

An innovative pedestrian signal display has been tested in Canada and has been included in the 2003 MUTCD.⁽⁸⁾ The animated eyes display (see figure 23-7) prompts pedestrians to look for vehicles in the

intersection during the time that the WALK signal indication is displayed. In this pedestrian signal application, the white eyeballs in the animated display scan from side to side. Other significant pedestrian treatments used in Canada include the following:

- Advance stop lines at marked crosswalks to improve pedestrian visibility (while crossing).
- Countdown displays for pedestrians signals.
- Pedestrian-activated flashing amber beacons at uncontrolled intersections and midblock locations.
- Multifaceted community approaches that include engineering, education, encouragement, enforcement, and evaluation.



Figure 23-7. Photo. Animated eyes display used in conjunction with pedestrian signal.

Pedestrian Zones

Pedestrian zones have been established on many downtown streets in Germany. These zones can also be used by cyclists during off-peak hours (e.g., evenings). Not only are there fewer conflicts with pedestrians during off-peak hours, but it was claimed that the presence of pedestrian and bicycle traffic helped eliminate crime and added an element of personal safety. The pedestrian mall shown in figure 23-8 allows bus, bike, and taxi travel throughout the day. In Freiburg, on Kaiser Josef, a pedestrian street, cars and bicycles are not permitted. Streetcars and pedestrians have exclusive use of the street.



*(This picture shows a bicyclist not wearing a helmet.
FHWA strongly recommends that all bicyclists wear helmets.)*

Figure 23-8. Photo. Pedestrian mall in Munster, Germany.

Source: *FHWA Study Tour for Pedestrian and Bicyclist Safety
in England, Germany, and The Netherlands*⁽¹⁾

23.4 Bicycle Facilities and Programs

The Netherlands

The general philosophy in The Netherlands is to separate bicyclists from motor vehicles whenever speeds increase to greater than 30 km/h (20 mi/h). According to one official, bicycle paths are safer than bike lanes between intersections. At intersections, however, a separate bicycle path will generally have a higher number of crashes. Separate bicycle paths (see figure 23-9) are considered desirable under heavy motor vehicle traffic conditions, but undesirable along streets with low volumes of motor vehicles. Their general approach to bicycle facilities is to avoid making them too sophisticated.

Bike lanes are typically wide enough for two cyclists to ride side-by-side. The bike lanes are generally reddish in color, with visible (and well-maintained) white bicycle symbol markings (see figure 23-10). Bike lanes are typically located between the motor vehicle lane and the sidewalk and are sometimes part of the sidewalk. Sometimes, problems occur with motor vehicles parked on the bicycle lane. Bike lanes are sometimes marked through intersections, as shown in figure 23-11.



*(This picture shows bicyclists not wearing helmets.
FHWA strongly recommends that all bicyclists wear helmets.)*

Figure 23-9. Photo. Bicycle path in The Netherlands parallels the high-speed roadway.

Source: FHWA Study Tour for Pedestrian and Bicyclist Safety in England, Germany, and The Netherlands⁽¹⁾



*(This picture shows bicyclists not wearing helmets.
FHWA strongly recommends that all bicyclists wear helmets.)*

Figure 23-10. Typical bicycle lanes in The Netherlands have red pavement color and are wide enough for two bicyclists.

Source: FHWA Study Tour for Pedestrian and Bicyclist Safety in England, Germany, and The Netherlands⁽¹⁾



*(This picture shows bicyclists not wearing helmets.
FHWA strongly recommends that all bicyclists wear helmets.)*

Figure 23-11. Photo. Bicycle lane markings carried through an intersection in The Netherlands.

Source: FHWA Study Tour for Pedestrian and Bicyclist Safety in England, Germany, and The Netherlands⁽¹⁾

In The Netherlands, separate bicycle signals are commonly used at arterial intersections that have bike lanes and high volumes of bicyclists and motor vehicle traffic. The bicyclist signals are vertical red, amber, and green bicycle symbols mounted on a pole, as shown in figure 23-12. They are located either next to the vehicle signal head [i.e., using the same 20-cm (8-in) diameter signal face as the vehicle signal] or at a lower level (1 m or 3 ft high) using a smaller size signal face (7 to 7.5 cm or 3 in). The signal indications are all steady (i.e., no flashing indications), and there is typically an advance green phase for bicyclists, with a simultaneous red phase for right-turning motor vehicles. According to one local official, levels of compliance with the signal are generally not very high.

In some cities, such as The Hague and Groningen, a special bicycle phase allows bicyclists in the bike lane to proceed straight before motor vehicles (i.e., right-turning traffic) are allowed to proceed. Motor vehicles are not allowed to turn right on red in The Netherlands, although bicyclists are allowed to do so in certain cities and locations. Bicycle lanes are not typically placed to the right of parked cars, since motorists cannot see bicyclists as easily. It is common for bicycle lanes to end before intersections. Mixing traffic before an intersection promotes anticipation and interaction among road users at the crossing. Otherwise, automobile drivers turning right often are not fully aware of bicyclists and moped riders coming from an adjacent bicycle lane.

Renting a one- or three-speed bicycle in The Netherlands is relatively inexpensive, costing approximately the equivalent of \$6 U.S. per day or about \$30 U.S. per week. Bicycle rental shops are located throughout towns and cities, commonly at train stations. Information on bicycle rentals is provided at local hotels.



Figure 23-12. Photo. Bicycle signal used in Amsterdam, The Netherlands.

Source: *FHWA Study Tour for Pedestrian and Bicyclist Safety in England, Germany, and The Netherlands*⁽¹⁾

Germany

On-street bike lanes are installed on the street level and are typically painted red or installed with a red pavement surface. This type of facility is generally less expensive to install than off-street facilities. Bicycle lanes with continuous lane markings are reserved solely for bicyclists. If the lane is dashed, cars and trucks may use the space only when no bicycle is present.

Off-street bike lanes are sometimes installed on the sidewalk level, as shown in figure 23-13. Generally marked with a distinctive red color (which contrasts with the gray stone used for pedestrian walkways and the clear zones between the street and bike path), these lanes provide a greater separation between bicyclist and motor vehicles. When a parking lane exists, this separation allows room to open car doors without obstructing the bike path.

As observed in Munster, bike paths are typically 1.6 m (5.2 ft) wide (one direction on each side of the street), and the separation between cars and the bike path is generally 0.7 m (2.3 ft) wide. Some areas are narrower in cases where sufficient room does not exist. This type of facility was originally promoted in the 1940s as a means to eliminate the hindrance that bikes were causing to cars. They are now retained to separate cars and bicyclists for safety purposes.

Bike tracks are generally paths through the countryside and are signed routes. They are generally not paved.



*(This picture shows bicyclists not wearing helmets.
FHWA strongly recommends that all bicyclists wear helmets.)*

Figure 23-13. Photo. Sidewalk-based bicycle path used in Germany.

*Source: FHWA Study Tour for Pedestrian and Bicyclist Safety
in England, Germany, and The Netherlands⁽¹⁾*

Bus lanes that can also be used by bikes require a width of 4.5 m (15 ft) or more to allow buses to easily and safely overtake cyclists when necessary. As shown in figure 23-14, these facilities are signed and marked with a bus and bike symbol.



*(This picture shows bicyclists not wearing helmets.
FHWA strongly recommends that all bicyclists wear helmets.)*

Figure 23-14. Photo. Shared bus and bicycle lane in Germany.

*Source: FHWA Study Tour for Pedestrian and Bicyclist Safety
in England, Germany, and The Netherlands⁽¹⁾*

Intersection improvements that facilitate bike travel include an advance stop line that allows bicyclists to exit sidewalk paths to turn left in front of motorized traffic. This provides a safer path for left-turning cyclists, provides better visual contact between bikes and cars, and allows bicyclists to be away from vehicle exhaust. This design has been found to be safer than the traditional weave operation. Other signal treatments include special advance green signals for cyclists, and in some cases, signals timed for bicycle traffic (based on a signal progression of approximately 15 km/h or 9 mi/h). It was also observed during site visits that traffic signal heads in Munster had one green bicycle signal head and two red bicycle signal heads. This was done to improve the visibility of the red bicycle signal.

Bicycle parking lockers and sheltered spaces are offered at some park-and-ride or park-and-bike lots at transit stations (see figure 23-15). Each bike locker can hold two bikes and provides better security for more expensive bicycles than at bicycle shelters. The rental fee for bike lockers is the equivalent of \$11.70 U.S. per month, which is much less expensive than car parking.



Figure 23-15. Photo. Example of bicycle shelters located at a transit station in Germany.

Source: *FHWA Study Tour for Pedestrian and Bicyclist Safety in England, Germany, and The Netherlands*⁽¹⁾

The particular lot shown in figure 23-15 has 108 car parking spaces and is on the outskirts of the built-up area of the city. The construction cost is much less for bike parking facilities than for car parking. Furthermore, about 10 to 12 bikes can be parked in a single car-parking space.

Bike parking at the train station facilitates train-bike combination trips. Bikes are parked in monitored areas and can be parked for four days before being moved to a long-term parking area. This allows train commuters to leave their bikes at the train station over the weekend. The City of Munster is also planning a 4,000-space underground bicycle parking facility at the train station.

Separate signal heads for bicyclists, as well as separate distinctive signal heads for trolleys, are used where exclusive bus lanes exist (using vertical or horizontal white lines as bus signal displays). This often results in three sets of signal heads side-by-side (car, trolley, and bike).

Installing bike racks at corners also helps intersection visibility. The study team was shown an intersection where car parking at the intersection had previously created a visibility problem for motorists on the side street. The problem occurred even after NO PARKING signs were posted. Installing bike racks at the corner physically prevented car parking and opened up sight distances for side-street traffic.

The United Kingdom

A variety of bicycle fatalities occur in the United Kingdom, particularly in smaller cities such as York and Cambridge, U.K., which have extensive networks of bicycle lanes and paths. Bicycle lanes are commonly narrow; some were observed by the study team to be 1 m (3 ft) wide or less in many cases. Along some city streets, contraflow bike lanes exist; that is, one-way bicycle lanes move in the opposite direction to one-way motor vehicle traffic (see figure 23-16). Double yellow lines next to the curb mean no parking.



*(This picture shows bicyclists not wearing helmets
FHWA strongly recommends that all bicyclists wear helmets.)*

Figure 23-16. Photo. Narrow contraflow bicycle lane in Cambridge, U.K.

*Source: FHWA Study Tour for Pedestrian and Bicyclist Safety
in England, Germany, and The Netherlands⁽¹⁾*

In some areas of the United Kingdom, bicycle trails allow for long-distance cycling separate from motor vehicles (see figure 23-17). Entrances onto these trails are designed to prevent most types of motor vehicles (including motorcycles) from entering (see figure 23-18). Such barriers cause some problems for bicyclists who enter or exit the trail. Bicyclists are also allowed to use an extensive network of exclusive bus lanes throughout London. In York, an abandoned rail line became an excellent bicycle facility by using existing bridges and underpasses. A 1,600-km (1,000-mi) cycle route network for London is planned over the next several years.



(This picture shows bicyclists not wearing helmets. FHWA strongly recommends that all bicyclists wear helmets.)

Figure 23-17. Photo. Bicycle trail on an abandoned railroad right-of-way south of York, U.K.

Source: *FHWA Study Tour for Pedestrian and Bicyclist Safety in England, Germany, and The Netherlands*⁽¹⁾



(This picture shows a bicyclist not wearing a helmet. FHWA strongly recommends that all bicyclists wear helmets.)

Figure 23-18. Photo. The entrance to this bicycle trail is designed to restrict entry to motor vehicles.

Source: *FHWA Study Tour for Pedestrian and Bicyclist Safety in England, Germany, and The Netherlands*⁽¹⁾

23.5 Student Exercise

Compare and contrast local U.S. and European bike and pedestrian facilities as well as lifestyles. Would the European facilities make sense in the United States? Would they be used?

23.6 References and Additional Resources

The references for this lesson are:

1. Zegeer, C.V., M. Cynecki, J. Fegan, B. Gilleran, P. Lagerwey, C. Tan, and B. Works, *FHWA Study Tour for Pedestrian and Bicyclist Safety in England, Germany, and The Netherlands*, Publication No. FHWA-PL-95-006, FHWA, October 1994, available online at <http://ntl.bts.gov/DOCS/bikeped.html>.
2. Pucher, J., and L. Dijkstra, "Promoting Safe Walking and Cycling to Improve Public Health: Lessons From the Netherlands and Germany," *American Journal of Public Health 1509-1516*, vol. 93, no. 9, September 2003, available online at <http://www.ajph.org/cgi/content/abstract/93/9/1509>, accessed May 3, 2004.
3. Lalani, N., *Alternative Treatments for At-Grade Pedestrian Crossings*, Report No. LP-629, ITE, 2001.
4. Nabti, J., and M. Ridgway, *Innovative Bicycle Treatments: An Informational Report*, Publication No. IR-114, ITE, 2002.
5. Davies, D.G., *Research, Development, and Implementation of Pedestrian Safety Facilities in the United Kingdom*, Publication No. FHWA-RD-99-089, FHWA, December 1999, available online at <http://www.fhwa.dot.gov/tfhrc/safety/pubs/99089/intro.htm>.
6. Ekman, L., and C. Hyden, *Pedestrian Safety in Sweden*, Publication No. FHWA-RD-99-091, FHWA, December 1999, available online at <http://www.fhwa.dot.gov/tfhrc/safety/pubs/99091/99091.pdf>.
7. Zegeer, C.V., J.R. Stewart, H.H. Huang, and P.A. Lagerwey, *Safety Effects of Marked vs. Unmarked Crosswalks at Uncontrolled Locations: Executive Summary and Recommended Guidelines*, Publication No. FHWA-RD-01-075, FHWA, March 2002, available online at http://www.walkinginfo.org/pdf/r&d/crosswalk_021302.pdf.
8. Van Houten, R., and J.E.L. Malenfant, *Canadian Research on Pedestrian Safety*, Publication No. FHWA-RD-99-090, FHWA, December 1999, available online at <http://www.fhwa.dot.gov/tfhrc/safety/pubs/99090/intro.htm>.

Additional resources for this lesson include:

- Hummel, T., *Dutch Pedestrian Safety Research Review*, Publication No. FHWA-RD-99-092, FHWA, December 1999, available online at <http://www.fhwa.dot.gov/tfhrc/safety/pubs/99092/intro.htm>.
- Cairney, P., *Pedestrian Safety in Australia*, Publication No. FHWA-RD-99-093, FHWA, December 1999, available online at <http://www.fhwa.dot.gov/tfhrc/safety/pubs/99093/intro.htm>.

LESSON 24:

A COMPREHENSIVE APPROACH: ENGINEERING, EDUCATION, ENCOURAGEMENT, ENFORCEMENT, AND EVALUATION

24.1 Introduction

Experience has shown that developing bicycle- and pedestrian-friendly communities requires a comprehensive approach that includes more than simply engineering and constructing bike lanes and sidewalks. This comprehensive approach includes:

- Engineering—designing and constructing roads for bicyclists and pedestrians.
- Education—teaching or training bicyclists, pedestrians, motorists, and other road users.
- Enforcement—ensuring that all road users follow traffic laws and rules of the road.
- Encouragement—providing incentives beyond physical infrastructure.
- Evaluation—confirming that the intended outcomes have been produced.

Many of the previous lessons in this *Student Workbook* have concentrated on the engineering aspects of bicycle and pedestrian transportation. This lesson explores the fundamental elements of education, enforcement, and encouragement programs for bicycling and walking by providing examples of successful programs from around the country. The major sections of this lesson are as follows:

- 24.1 Introduction
- 24.2 The Importance of Comprehensive Programs
- 24.3 Integrating Elements in a Comprehensive Approach
- 24.4 Elements of an Effective Education Program
- 24.5 Elements of an Effective Enforcement Program
- 24.6 Elements of an Effective Encouragement Program
- 24.7 Evaluation of Bicycle and Pedestrian Programs
- 24.8 Student Exercise
- 24.9 References and Additional Resources

This lesson on comprehensive approaches has been derived from the *National Bicycling and Walking Case Study 11: Balancing Engineering, Education, Law Enforcement, and Encouragement*.⁽¹⁾

24.2 The Importance of Comprehensive Programs

Historically, providing for bicyclists meant providing bicycle facilities. This was the focus during the early phase of program development in the United States. By the late 1970s, some progressive communities such as Boulder, CO, and Madison, WI, replaced that focus with a more comprehensive 4E approach that combined engineering and planning with enforcement, education, and encouragement (see figure 24-1).

By then, it had become clear that simply providing a bicycle- and pedestrian-friendly road or trail environment, as important as it is, cannot solve all bicycle and pedestrian problems. Some safety problems, for example, may be more easily solved through programs than through facilities. In order to understand the importance of the other elements of a comprehensive program, consider the following two examples.



Figure 24-1. Photo. Comprehensive bicycle and pedestrian programs include more than bike lanes and sidewalks.

Source: PBIC

Image Library, <http://www.pedbikeimages.org>⁽²⁾

Example One

A person decides to ride her bicycle to work. Between home and the office, she rides a road with bicycle-friendly design features (e.g., wide outside lanes, bicycle lanes, etc.). While riding, she barely misses a 10-year-old wrong-way rider coming at her, is almost cut off by a motorist turning left in front of her, and finally finds no place to securely park her bicycle at the office. She locks her bike to the leg of a newspaper rack and goes into the office. When she leaves work, the sun has gone down; she has no bike lights. She calls a taxi to take her and her bicycle home.

While she was able to take advantage of one element of a comprehensive program (the on-road facilities), the lack of other elements caused her serious inconvenience and danger. Youngsters need to learn which side of the road to use, and the traffic laws should be enforced; motorists should learn to watch for bicyclists and to yield to them just as they would to other motorists. Common bicyclist and motorist errors that lead to many crashes can be addressed through education, enforcement, and awareness programs. Secure and convenient bicycle parking should be provided at all popular destinations as a routine matter. In some communities, this is dealt with in the parking ordinance.

Example Two

A person gets in his car on a sunny summer afternoon to drive to a nearby store. The store is less than 1 km (0.6 mi) away, and he is buying a quart of milk. There are sidewalks, but he doesn't even think of walking. He drives there, buys his milk, and drives home.

While the existence of sidewalks or places to walk is important, it does not necessarily convince people to walk if they habitually take a car for every trip. The average American household generates 10 auto trips per day, many of them short-distance errands. Breaking the driving habit requires effort and understanding. A good awareness campaign, including media spots and other elements, can help develop that understanding and encourage people to make the effort to walk for short trips. Walking takes little extra time compared to driving for very short distances. When one considers the costs (environmental, economic, personal health) of driving and the exercise and health benefits of walking, walking is often preferable.

These two hypothetical examples point out the importance of going beyond the earlier focus on facilities alone to include other aspects as well. They suggest the potential roles that agencies such as the police department, the school district, and private parties such as the local television station and newspaper can play in improving the bicycling and walking situation in a community.

It is important to keep in mind that some elements may not contribute directly to an increase in numbers of nonmotorized travelers. However, these elements are important for other reasons, primarily safety.

24.3 Integrating Elements in a Comprehensive Approach

How, exactly, can an effective mix of engineering, enforcement, education, and encouragement be determined? The answer is that participants from a wide range of agencies and groups must get involved in the process. The Geelong, Australia, model is a good one to illustrate this point. The Geelong Bike Plan Team included members from the enforcement community, roads department, safety agencies, school system, and bicycling community (see figure 24-2). In assembling their comprehensive program, the project managers enlisted the help of those who would, ultimately, be responsible for implementing it.



Figure 24-2. Photo. Comprehensive bicycle and pedestrian programs bring together a variety of stakeholders.

This is the process suggested here. A bike-pedestrian plan task force should be assembled to guide the program. The following structure is suggested for the task force. While the same department may be represented on several committees, this would not necessarily require different individuals. Individual members should deal with those aspects within their areas of expertise. Committees might be formed to include areas of expertise, as shown below:

- Steering committee
 - Physical environment
 - Education and awareness
 - Encouragement
 - Data collection
- Physical environment
 - Public works (traffic engineering, streets)
 - Planning (transportation, land use)
 - Parks and recreation (parks planning)
 - Cyclists and pedestrians
 - College campus planning
- Education and awareness
 - Parks and recreation (programming)
 - School district (elementary and junior high)
 - High school and college
 - Health
 - Cyclists and pedestrians
- Enforcement
 - Police (traffic)
 - Cyclists and pedestrians

Determining the Scope of a Comprehensive Program

Because so little is known about the bicycling and walking situations in most communities, it is difficult to predict in advance what level of expenditure and program activity will be needed to implement a comprehensive program. Until the needs have been identified and the problems assessed, the necessary scope of the program will probably remain unknown. However, the basic approach suggested here is to make bicycle and pedestrian considerations part of the normal process of governing. In many cases, this may require little extra expense.

For example, if a police officer stops a bicyclist for running a red light, this should not be seen as a new or extra duty. It is simply part of traffic enforcement and it will pay the community back in terms of decreased crash rates. Similarly, adding pedestrian- or bicycle-related questions to a transportation needs survey will not necessarily require large amounts of money. It allows transportation planners to do a better job of planning for the community's travel needs and can pay off in reduced motorized travel demand. Finally, changing a dangerous drainage grate standard to a bicycle-safe design costs no more, but can reduce an agency's potential liability.

There will be some projects (e.g., a new bicycle bridge) that require a significant expenditure of funds. However, if the need for a project is clearly documented through surveys and studies, it can take its place

in the TIP. In such an arena, its strengths and weaknesses can be weighed against those of other potential projects.

Steps in the Process

There are four primary steps in the process of mixing the elements of engineering, education, enforcement, and encouragement to create a comprehensive bicycle and pedestrian program.

First, it is important to develop an understanding of the local bicycling and walking situations. This means looking closely at nonmotorized travel in the community to determine its limitations and potential, as well as current levels of use and safety problems. This understanding will form the basis for the work that follows.

The second step is to set realistic goals and objectives. These should be based on data from the information-gathering step, and they should be measurable and achievable.

Third, participants should address those goals and objectives through the development of an action plan. The plan should be a blueprint for the community's work in all the elements of the comprehensive program. It should include phasing and funding considerations.

Fourth, as work on the action plan progresses, it should be evaluated based on its effects on the goals and objectives. Without an evaluation process, it is impossible to determine the effects of one's work. With evaluation, one can judge and document success, correct errors, and fine-tune the program.

24.4 Elements of an Effective Education Program

This section contains examples of several elements and strategies that are commonly found in effective bicycle and pedestrian safety education programs. Additional examples of education programs can be found in *Good Practices for Bicycle Safety Education*.⁽³⁾

Provide Instruction in Lawful, Responsible Behavior Among Bicyclists, Pedestrians, and Motorists

Strategy 1: Teach important bicycling and walking skills to youngsters

Approach: Using information gathered from the user studies as well as the crash studies, work with school administrators and teachers to identify target ages for key educational messages. Review course options and identify opportunities for implementing bicycling and walking curricula for the target ages (see figure 24-3).

Result: A program of instruction that effectively reaches the target audience.

Examples: The Missoula, MT, school district has included bicyclist education in its core curriculum since 1980; the program is taught by physical education instructors. The Boulder, CO, bicycle-pedestrian program staff includes a full-time education person in charge of implementing curricula in cooperation with the local school system. The Madison, WI, program works with local schools to do the same.



Figure 24-3. Photo. Safety education programs are essential for young children.

Source: PBIC Image Library, <http://www.pedbikeimages.org>⁽²⁾

Strategy 2: Teach important bicycling and walking skills to adults

Approach: Using information gathered from the user studies as well as the crash studies, work with college and high school administrators and teachers to identify key educational messages. Review course options and identify opportunities for implementing bicycling and walking curricula for the target ages.

Result: A program of instruction that effectively reaches the target audience.

Examples: Effective cycling instructors in Seattle, WA, Tucson, AZ, and other communities have offered adult courses through the local junior colleges. Missoula, MT, and several other communities have offered cycling classes to traffic-law violators through the local municipal court systems.

Strategy 3: Include bike and pedestrian information in driver training

Approach: Using information from the crash studies, work with local driver training instructors and violators to identify key messages for delivery to new drivers, as well as those required to take remedial driving courses. Assemble a model curriculum unit and deliver it to all local instructors.

Result: A model curriculum and delivery mechanism for reaching drivers during training.

Examples: The Gainesville, FL, bicycle coordinator taught 14- and 15-year-old driver education students how to share the road with bicycles. The coordinator brought copies of bicycle/automobile crash reports to illustrate her points. She then divided the class into groups, each with a crash report. Groups analyzed how the crashes happened and how they could have been avoided.

Deliver Important Safety Messages Through Various Print and Electronic Media

Strategy 4: Determine which safety messages are most important for which audiences

Approach: Using information gathered from the crash studies, identify important messages for the whole range of target audiences (see figure 24-4).

Result: A prioritized list of messages identified as to their target audiences.

Examples: The Gainesville, FL, program determined that one of the audiences most in need of attention was the college student population. Key safety messages for these bicyclists were identified.



Figure 24-4. Photo. Target safety messages to key audiences through various media.

Strategy 5: Create a process for effectively delivering those messages

Approach: Work with the local media and other groups to determine the best way to reach the audiences identified above, given the resources available.

Result: A long-term strategy for delivering selected messages to key target audiences.

Examples: In 1986, working with local bicycling groups and the media, the Madison, WI, bicycle program created an ambitious bicycle helmet campaign. They did before-and-after studies of both helmet wearing rates and their success in delivering their messages. In Gainesville, FL, officials commissioned a safety specialist to create college student-oriented bicycling comic strips for publication in the campus newspaper and for printing as brochures.

24.5 Elements of an Effective Enforcement Program

This section contains examples of several elements and strategies that are commonly found in effective bicycle and pedestrian safety enforcement programs. Additional examples and information on enforcement programs can be found in the NHTSA *Resource Guide on Laws Related to Pedestrian and Bicycle Safety* (see figure 24-5).⁽⁴⁾

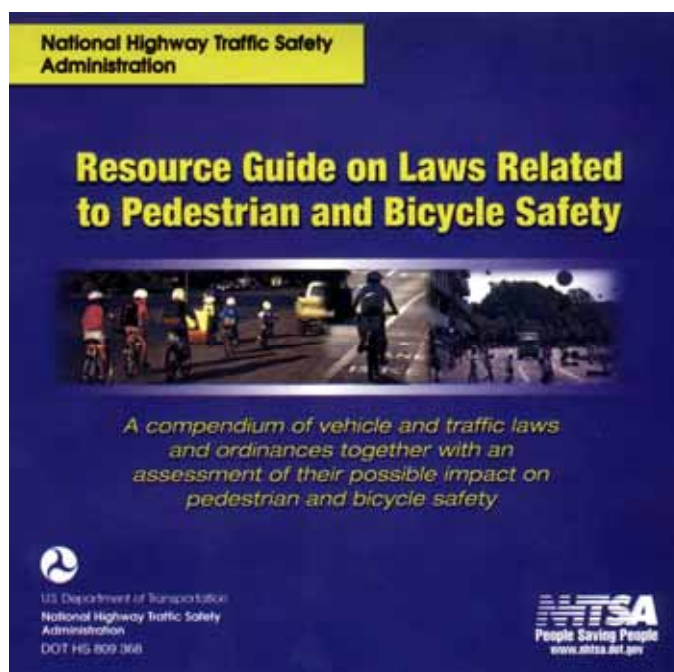

Figure 24-5. Photo. The NHTSA *Resource Guide* can be used to improve existing traffic laws.

Improve Existing Traffic Laws, as Well as Their Enforcement

Strategy 1: Review and, if necessary, modify laws that affect bicyclists and pedestrians

Approach: In cooperation with the police department and city attorney, review local and State bicycle and pedestrian laws and compare with the current version of the Uniform Vehicle Code and Model Traffic Ordinance (see <http://www.ncutlo.org/> for more information). Focus on those regulations that may unnecessarily restrict bicycle or pedestrian traffic or that seem out of date when compared to the national models.

Result: A report listing suggested changes to local and State traffic laws.

Examples: Palo Alto, CA, after reviewing potential crash problems and liability concerns, decided to allow bicycle traffic on a key expressway. In doing so, they opened a new route for fast crosstown travel.

Strategy 2: Enforce laws that impact bicycle and pedestrian safety

Approach: Using information from the crash studies, determine which traffic violations are implicated in the most common serious car/bike and car/pedestrian crashes. Work with the police department, traffic court, and city attorney to develop a plan for enforcing the key laws.

Result: A plan for equitable enforcement of bicycle, pedestrian, and motor vehicle traffic laws.

Examples: Since the mid-1980s, the Madison, WI, police department has staffed a bicycle monitor program with specially deputized university students to enforce bicycle traffic laws. The Seattle, WA, police department aggressively polices crosswalks and routinely tickets motorists for violating pedestrian rights-of-way. The Missoula, MT, bicycle patrol routinely tickets motorists who violate the law.

Strategy 3: Review and, if necessary, modify procedures for handling youthful violators

Approach: In cooperation with the police department, develop procedures for handling young bicycle and pedestrian law violators.

Result: A set of procedures for dealing with young bicyclists and pedestrians.

Examples: For years, Dallas, TX, operated a youth court for young bicyclists caught violating traffic laws. The City of Santa Barbara, CA, a pioneer in bicycle enforcement, developed a campaign that included special tickets for youngsters, a publicity campaign, and a training film for officers. Missoula, MT, has a special warning ticket for youngsters: one copy goes to the violator, one is mailed to the parents, and one is kept at the police station.

Reduce the Incidence of Serious Crimes Against Nonmotorized Travelers

Strategy 4: Develop a strategy for reducing the number of bikes stolen and increasing the proportion of recovered bikes

Approach: Based on the police department's bike theft study, develop a strategy for reducing the impact of bike theft rings and other sophisticated thieves. Also consider a means to inform the public of simple steps they can take to keep their bikes from being stolen.

Result: A plan for reducing bike theft in the community.

Examples: Missoula, MT, used their 1982 bicycle theft study as the basis for TV spots, appearances on news shows, news releases, brochures, and posters, all of which promoted using high-security locks. They also developed a computerized bicycle registration procedure that has helped identify and return many licensed bikes to their owners.

Strategy 5: Develop a strategy for reducing assaults on bicyclists and pedestrians

Approach: Based on the study of bicyclist and pedestrian harassment and assault, develop a standard procedure for dealing seriously with these complaints.

Result: Policies and procedures for dealing with bicyclist and pedestrian assault and harassment.

Examples: For years, the Missoula, MT, bicycle program has worked with the city attorney's office on a case-by-case basis to resolve complaints of bicyclist harassment. Their efforts resulted in irresponsible motorists receiving numerous warnings and citations.

Use Nonmotorized Modes to Help Accomplish Other Unrelated Departmental Goals

Strategy 6: Implement nonmotorized patrols in appropriate areas

Approach: Based on the experiences of other communities, determine the need and potential of nonmotorized patrols in the community and develop an implementation plan.

Result: A plan for funding and creating nonmotorized police patrols in the community.

Examples: Seattle, WA, has pioneered the mountain bike patrol as a way of dealing with street crime. Begun in 1987, the patrol has grown to more than 100 officers, and the founders have given training seminars to police departments all over the country (see figure 24-6). Each year, hundreds of mountain bike officers gather for a national conference sponsored by the League of American Bicyclists; many also attend the annual Beat the Streets patrol competition hosted by that city.



Figure 24-6. Photo. Police bicycle patrols are effective at outreach and crime prevention.

Source: PBIC Image Library, <http://www.pedbikeimages.org>⁽²⁾

24.6 Elements of an Effective Encouragement Program

This section contains examples of several elements and strategies that are commonly found in effective bicycle and pedestrian transportation encouragement programs. The Robert Wood Johnson Foundation has published an excellent resource for public health promoters and advocates entitled *Promoting Active Living Communities: A Guide to Marketing and Communication*.⁽⁵⁾ Specifically, this guide has five basic strategies it recommends for promoting pedestrian-friendly communities:

- Think like a marketer.
- Get to know your audience.
- Shape your program.

- Get your messages out.
- Evaluate your communication efforts.

Reduce or Eliminate Disincentives for Bicycling and Walking and Incentives for Driving Single-Occupant Motor Vehicles

Strategy 1: Add nonmotorized options to agency motor pools

Approach: Identify all agency motor pools and determine which can be modified to include bicycles. In addition, consider which trips can be efficiently taken on foot. Create a plan of action for adding nonmotorized options where possible. Promote the approach as a model for other local employment centers.

Result: A plan for using nonmotorized modes in satisfying agency transportation needs.

Examples: The City of Seattle, WA, recently created a nonmotorized pool, adding bicycles to the motor vehicles available for employee use. The bikes are proving to be extremely popular.

Strategy 2: Require companies and agencies to produce balanced transportation plans for their workforce's commuting needs

Approach: Review city policies and practices, as well as those of private companies and other large employers, that reward driving private automobiles or discourage walking or bicycling. Work with all appropriate agencies and companies to modify those provisions.

Result: A set of proposed options (policies, ordinances, programs) that address institutional biases against bicycling and walking.

Examples: In Palo Alto, CA, a transportation plan for Stanford University suggested helping staff purchase bicycles if they would use them for commuting to work. The City reimburses those who use their bicycles for work-related trips. The university campus in Davis, CA, has for many years severely restricted motor vehicle parking. This has been identified as one of the major factors in encouraging students and faculty to ride bikes to the campus.

Provide Ways for Nonparticipants to Receive a Casual Introduction to Bicycling and Walking

Strategy 3: Include entry-level bicycling and walking activities in local recreational programming

Approach: Identify existing programs or groups that could become sponsors for introductory-level bicycling and walking activities. Based on user studies, create a list of potential activities and match them with groups willing to offer sponsorship.

Result: A schedule of introductory-level nonmotorized recreational activities.

Examples: The Eugene, OR, recreation department sponsored a variety of recreational rides and workshops for novice adult riders through their network of parks. The Chesterfield County Parks Department in Richmond, VA, sponsors an annual Peanut Ride, which visits peanut farms in the area, allowing participants to learn more about local agriculture while getting exercise.

Strategy 4: Promote utilitarian nonmotorized transportation through introductory fun events

Approach: Through a combination of promotional events and media publicity, encourage citizens to walk or ride in place of driving.

Result: An annual series of promotions supporting nonmotorized travel.

Examples: The Boulder, CO, annual Bike Week has become a major event over the years, encompassing a schedule of senior citizen rides, bike polo, business challenges, bicycle parades, and nonpolluter commuter races. During that city's Bike to Work Day in 1992, approximately 7,000 people rode bicycles to work.

Strategy 5: Offer key target audiences detailed information on utilitarian nonmotorized travel

Approach: Based on the user studies, determine which audiences are most likely to bicycle or walk, further determine their detailed informational needs, and create a plan for getting that information to the target audience.

Result: A plan for giving detailed useful information to key target audiences.

Examples: The Ann Arbor, MI, program has run seminars at local hospitals and other employment centers, helping participants learn how commuting by bicycle might work for them. In Los Angeles, CA, the El Segundo Employers Association, in cooperation with the Southern California Association of Governments, has produced maps, pamphlets, and seminars to promote nonmotorized transportation among their workers.

Use Electronic and Print Media to Spread Information on the Benefits of Nonmotorized Travel

Strategy 6: Develop and disseminate a limited set of simple, but important, probicycling and prowalking messages

Approach: Based on the user studies, determine the educational needs of bicyclists and walkers, assemble a list of the most important messages, and create a media campaign to get them across. Include the experiences of current nonmotorized travelers as a way of personalizing the messages and lending added credibility.

Result: A media campaign promoting the benefits of bicycling and walking directed at key target audiences (see figure 24-7 for an example).

Examples: San Diego, CA, has used bus-mounted advertising to promote the benefits of nonmotorized travel. Seattle, WA, in cooperation with a local television station, has created a series of local promotional television spots.



Figure 24-7. Photos. Vehicle license plates that promote sharing the road with bicyclists.

24.7 Evaluation of Bicycle and Pedestrian Programs

A comprehensive bicycle and pedestrian program directed toward the goal of increasing safe travel by nonmotorized modes must combine the efforts of many people. No one office can do it all. Officials in public works, planning, enforcement, education, and recreation agencies all have a role and must work together to achieve the desired end.

In order to measure future success, it is important to first determine current conditions. Since nonmotorized travel is so seldom measured, we know little about it. With data on use, user attitudes and behavior, safety, and security problems, it is possible to begin assembling an achievable set of goals and objectives. These goals and objectives should be used to guide the development and implementation of an action plan. The plan should include physical elements such as roadway improvements and trail systems, as well as nonphysical elements such as enforcement and educational programs.

Evaluating the elements of the action plan is a critical step in determining future direction and past success. Success should be measured in terms of both services delivered and effects achieved. Evaluation must be seen as a key ingredient to implementation, rather than as an extra duty to be performed if there is time or money.

Combining these steps into a comprehensive program will allow a community to achieve and measure success.

24.8 Student Exercise

Exercise A

Volunteer at a bicycle or pedestrian education event.

Exercise B

Identify the organization, group, or committee that deals with engineering, education, and enforcement in the local area. If there is a group, sit in on a meeting and see what activities and issues there are in the community and how the class might help or participate as part of a class project.

Exercise C

Identify the education and enforcement activities in your community and critique and compare the elements in your community with the examples in the lessons. Work with public officials on how to make revisions to the programs and/or policies.

24.9 References and Additional Resources

The references for this lesson are:

1. "Case Study No. 11: Balancing Engineering, Education, Law Enforcement, and Encouragement," *National Bicycling and Walking Study*, Publication No. FHWA-PD-93-009, FHWA, Washington, DC, 1994.
2. Image Library, PBIC, available online at <http://www.pedbikeimages.org>, accessed May 6, 2004.

3. *Good Practices Guide for Bicycle Safety Education*, FHWA, Publication No. FHWA-SA-02-001, available online at <http://www.bicyclinginfo.org/ee/bestguidedoc.html>, accessed May 3, 2004.
4. *Resource Guide on Laws Related to Pedestrian and Bicycle Safety*, NHTSA, Publication No. DOT-HS-809-368, available online at <http://www.nhtsa.dot.gov/people/injury/pedbimot/bike/resourceguide/>, accessed May 4, 2004.
5. *Promoting Active Living Communities: A Guide to Marketing and Communication*, The Robert Wood Johnson Foundation, available online at http://www.activelivingbydesign.org/fileadmin/template/documents/rwjf_toolkit.pdf

